

Elam e Awan

3000-2400 a.C.



- Sumerogramma **NIM.KI** ricorre in alcuni testi di Uruk (lista di schiavi, lista di ufficiali)
- Ricorre in testi protodinastici di UR e di Fara come luogo di provenienza di alcune persone i cui nomi però non sembrano avere radici elamiche
- In alcuni testi di Abu Salabih si nomina un dio ^d*Lugal-NIM*.
 - ^d*Lugal-aratta*
 - ^d*Lugal-NIM*
 - ^d*Lugal-shushinak*
- Lista dei re (SKL)
 - Ermebaragesi di Kish attacca **Elam**
 - Ur fu attaccata e cade sotto il dominio di **Awan**
 - **Awan** fu attaccata e cade sotto il dominio di Kish
- Testi presargonici di Lagash
 - Governo di una dinastia elamita basata ad Awan
 - Serie di conquiste durante il regno di Eannatum in cui si riportano campagne contro Elam, Mishime, Arawa e Uru'aza
 - Periodo in cui questi territori non più bellicosi intrattengono relazioni commerciali con Lagas

AWAN, name of a place in ancient western Iran, the nominal dynastic seat of Elamite rulers in the late third millennium B.C.; its location is unknown.

Three rulers of Awan form the fourth post-diluvium “dynasty” in at least four manuscripts of the Sumerian King List. The King List is a schematic and tendentious document (possibly compiled as early as 2100 B.C., though extant manuscripts are two to four centuries younger); the context of the Awan section suggests that it was meant to refer to a period beginning ca. 2500-2400 B.C. Its historicity is questionable.



Susa

Data (a.C.)	Lowland	Highland	Mesopotamia
4300	Susa I	Tal-i-Bakun A III-IV	Ubaid III-IV
3800-3100	Susa II	Tal-i Bakun A (Lapui) Tal-i Malyan early Banesh	Uruk medio e tardo
3100-2900	Susa III	Tal-i Malyan late Banesh	Uruk Tardo/Jemed nasr
2900-2350	Susa IIIc, Susa IVa	Godin Tepe III Abbandono di Tal-i Malyan	Protodinastico I-III
2330	Susa IVb		Impero di Akkad Conquista di Susa

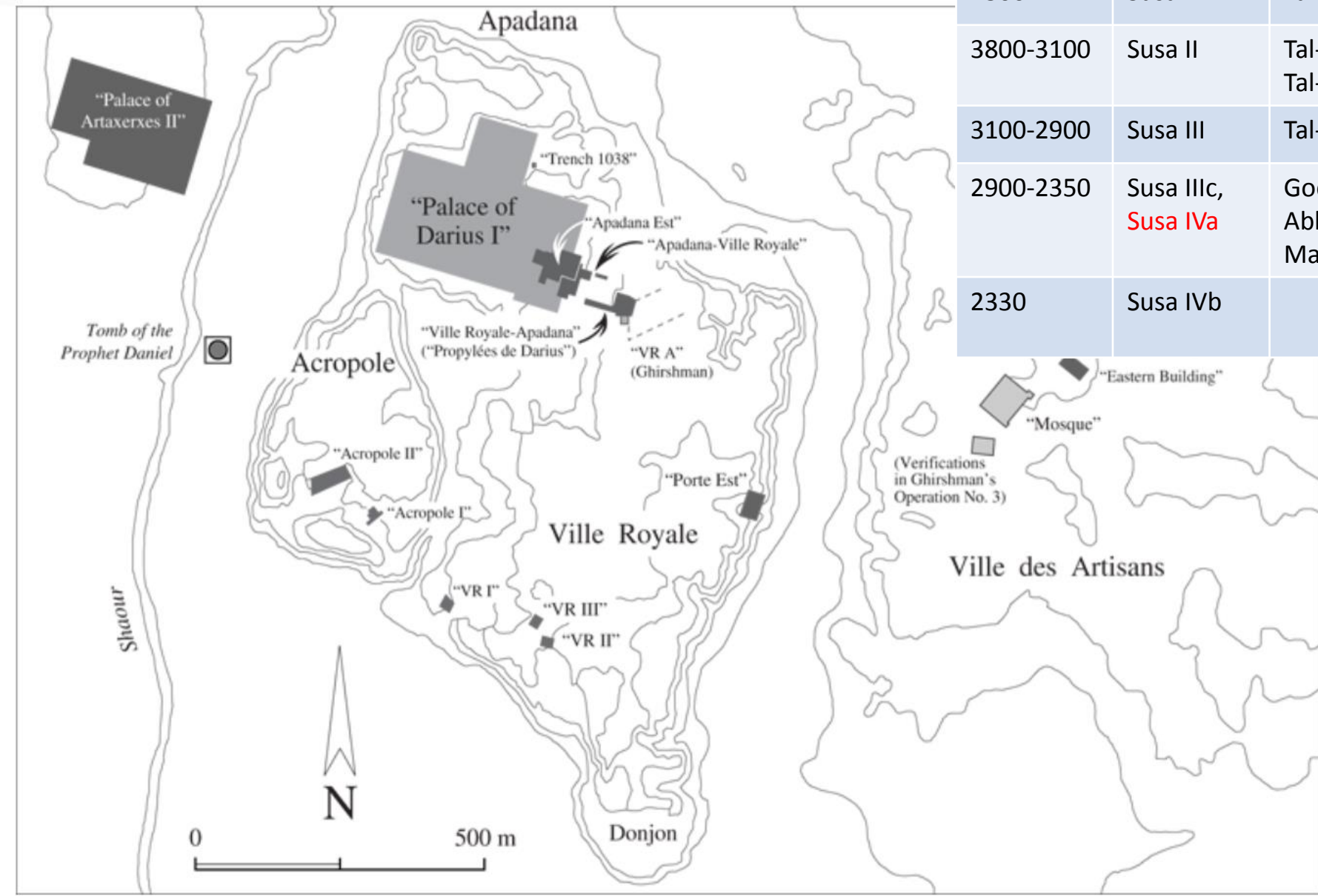

Susa IVa: tombe e forni della ceramica identificati sotto il palazzo di Dario. Forse un tempio si trovava sull'acropoli (alcune placche e statue). Dal donjon: gruppo di sigilli e serie di tombe.

FIGURE 2. The main sites (indicated by numerals) worked at Susa under the direction of Jean Perrot, 1968-79.

Data (a.C.)	Lowland	Highland	Mesopotamia
4300	Susa I	Tal-i-Bakun A III-IV	Ubaid III-IV
3800-3100	Susa II	Tal-i Bakun A (Lapui) Tal-i Malyan early Banesh	Uruk medio e tardo
3100-2900	Susa III	Tal-i Malyan late Banesh	Uruk Tardo/Jemed nasr
2900-2350	Susa IIIc, Susa IVa	Godin Tepe III Abbandono di Tal-i Malyan	Protodinastico I-III

- Possibile interruzione tra 2900-2800
- Produzione locale di vasi in mastice di bitume
- **Glittica e statuaria di stile mesopotamico**
- Tombe con repertorio ceramico peculiare (Susa IV)

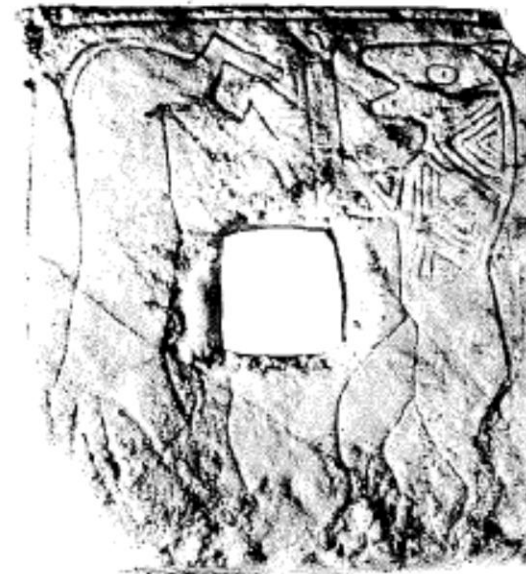

60. Suse. Plaque perforée de style dynastique archaïque II. Voir p. 121.



61. Suse. Epoque des Dynasties archaïques. Statue royale. Voir p. 123.



Data (a.C.)	Lowland	Highland	Mesopotamia
4300	Susa I	Tal-i-Bakun A III-IV	Ubaid III-IV
3800-3100	Susa II	Tal-i Bakun A (Lapui) Tal-i Malyan early Banesh	Uruk medio e tardo
3100-2900	Susa III	Tal-i Malyan late Banesh	Uruk Tardo/Jemdet Nasr
2900-2350	Susa IIIc, Susa IVa	Godin Tepe III Abbandono di Tal-i Malyan	Protodinastico I-II

- Possibile interruzione tra 2900-2800
- Produzione locale di vasi in mastice di bitume
- Glittica e statuaria di stile mesopotamico
- Tombe con repertorio ceramico peculiare (Susa D)



Statue di oranti della Mesopotamia



1. Suse. Epoque des Dynasties archaïques. Statue royale. Voir p. 123.



Data (a.C.)	Lowland	Highland	Mesopotamia
4300	Susa I	Tal-i-Bakun A III-IV	Ubaid III-IV
3800-3100	Susa II	Tal-i Bakun A (Lapui) Tal-i Malyan early Banesh	Uruk medio e tardo
3100-2900	Susa III	Tal-i Malyan late Banesh	Uruk Tardo/Jemed nasr
2900-2350	Susa IIIc, Susa IVa	Godin Tepe III Abbandono di Tal-i Malyan	Protodinastico I-III

- Possibile interruzione tra 2900-2800
- Produzione locale di vasi in mastice di bitume
- **Glittica e statuaria di stile mesopotamico**
- Tombe con repertorio ceramico peculiare (Susa D)

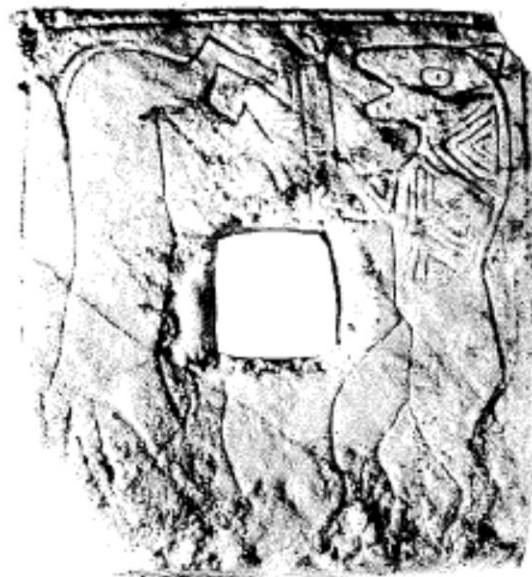

60. Susa. Plaque perforée de style dynastique archaïque II. Voir p. 121.



Placca di Ur-Nanshe, tello PDIII

Data (a.C.)	Lowland	Highland	Mesopotamia
4300	Susa I	Tal-i-Bakun A III-IV	Ubaid III-IV
3800-3100	Susa II	Tal-i Bakun A (Lapui) Tal-i Malyan early Banesh	Uruk medio e tardo
3100-2900	Susa III	Tal-i Malyan late Banesh	Uruk Tardo/Jemed nasr
2900-2350	Susa IIIc, Susa IVa	Godin Tepe III Abbandono di Tal-i Malyan	Protodinastico I-III



61. Suse. Epoque des Dynasties archaïques. Statue royale. Voir p. 123.

- Vasi in mastice di bitume
 - Bitume+calcare fuso +argilla
- Tecnica nota nella susiana fin dal IV millennio ma applicata a prodotti di lusso durante il PDII-III

62. Suse. Vase en mastic de bitume. Voir p. 123.



64. Suse. Vase en mastic de bitume à décor architectural. Voir p. 124, 137.



63. Suse. Vase en mastic de bitume. Voir p. 123.

- Vasi in mastice di bitume
 - Bitume+calcare fuso +argilla
- Tecnica nota nella susiana f dal IV millennio ma applicat a prodotti di lusso durante PDII-III



62. Suse. Vase en mastic de bitume. Voir p. 123.



64. Suse. Vase en mastic de bitume à décor architectural. Voir p. 124, 137.

61. Suse. Epoque des Dynasties archaïques. Statue royale. Voir p. 123.



63. Suse. Vase en mastic de bitume. Voir p. 123.

Data (a.C.)	Lowland	Highland	Mesopotamia
4300	Susa I	Tal-i-Bakun A III-IV	Ubaid III-IV
3800-3100	Susa II	Tal-i Bakun A (Lapui) Tal-i Malyan early Banesh	Uruk medio e tardo
3100-2900	Susa III	Tal-i Malyan late Banesh	Uruk Tardo/Jemed nasr
2900-2350	Susa IIIc, Susa IVa	Godin Tepe III Abbandono di Tal-i Malyan	Protodinastico I-III



64. Suse. Vase en mastic de bitume à décor architectural. Voir p. 124, 137.

- Vasi in mastice di bitume
 - Bitume+calcare fuso +argilla
- Tecnica nota nella susiana fin dal IV millennio ma applicata a prodotti di lusso durante il PDII-III

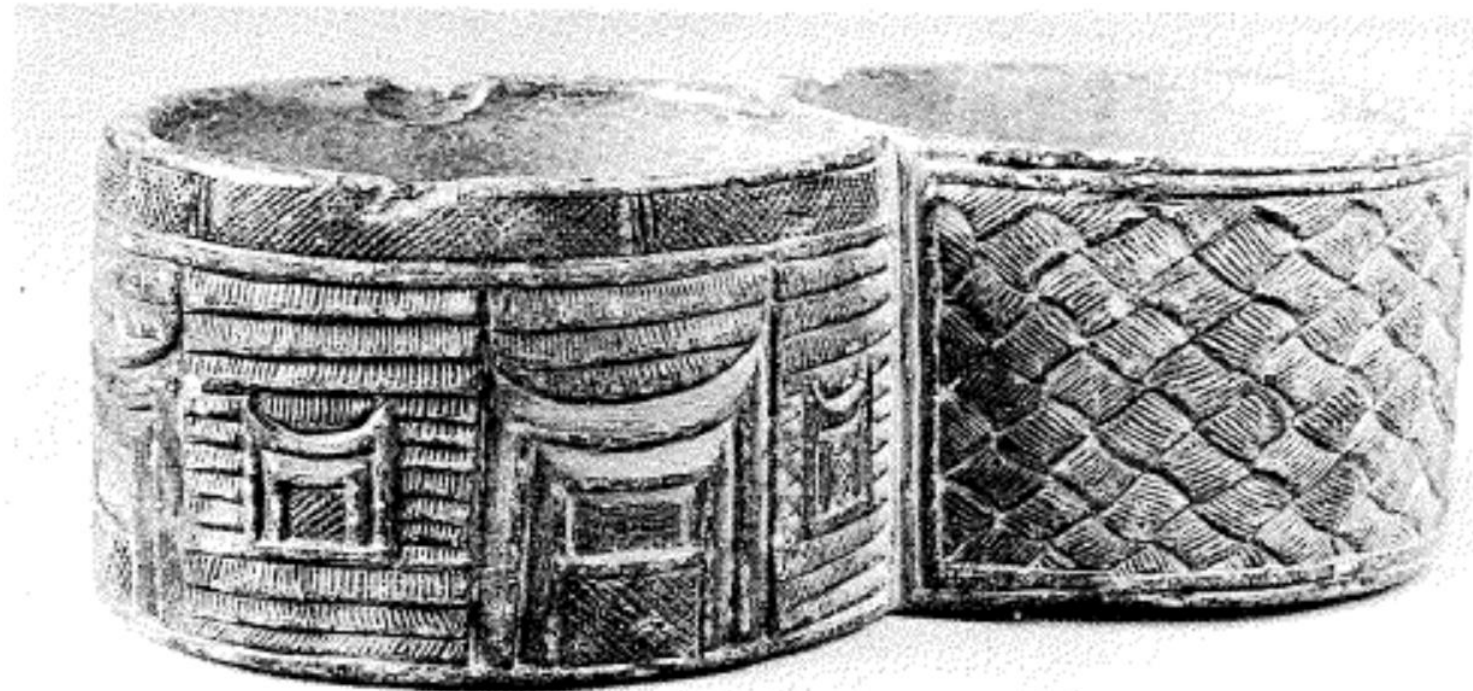

70. Suse. Epoque des dynasties archaïques. Vase à décor architectural. Chlorite. Voir p. 124, 137.



65. Suse. Relief en mastic de bitume. Epoque des dynasties archaïques. Voir p. 124.

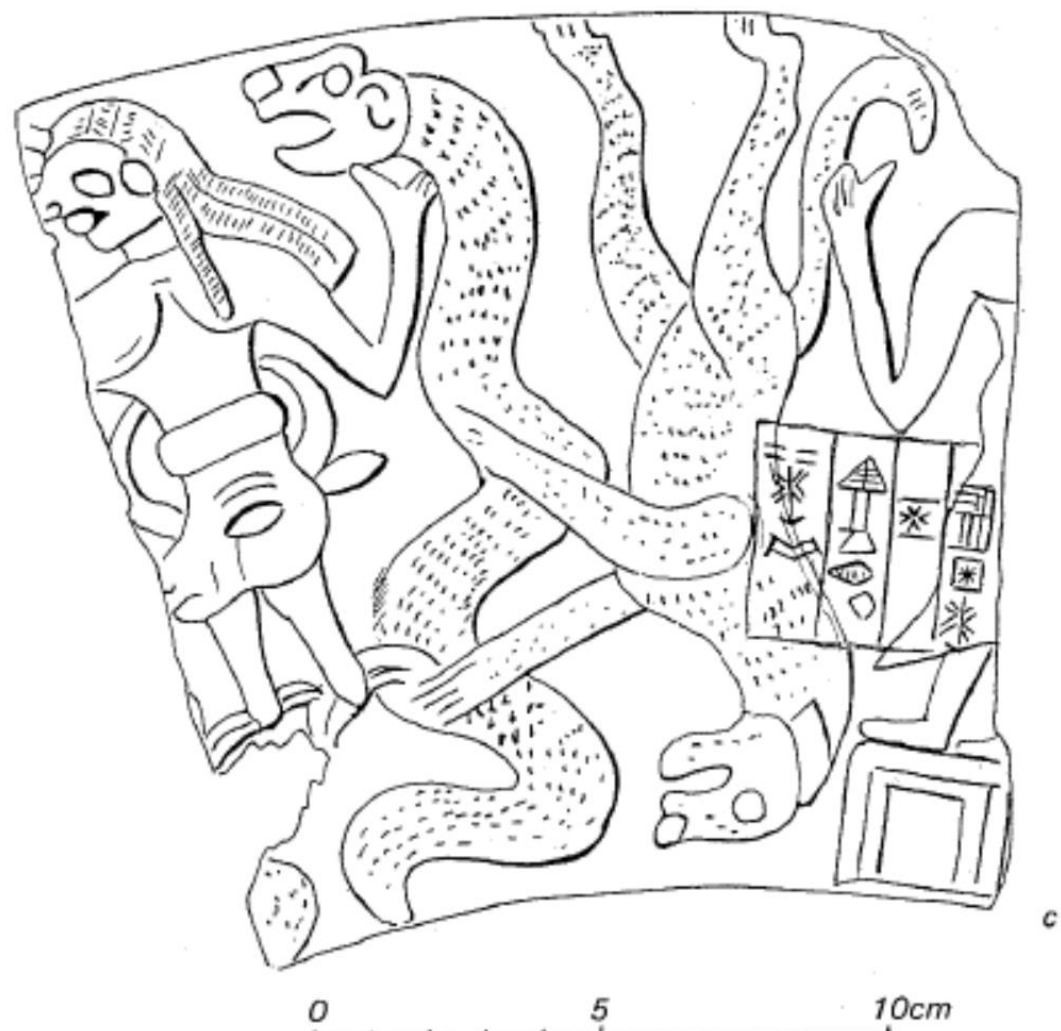

Iran du Sud-Est. Gobelet en chlorite avec inscription sumérienne. Milieu du III^e mi
r p. 124, 136, 169.

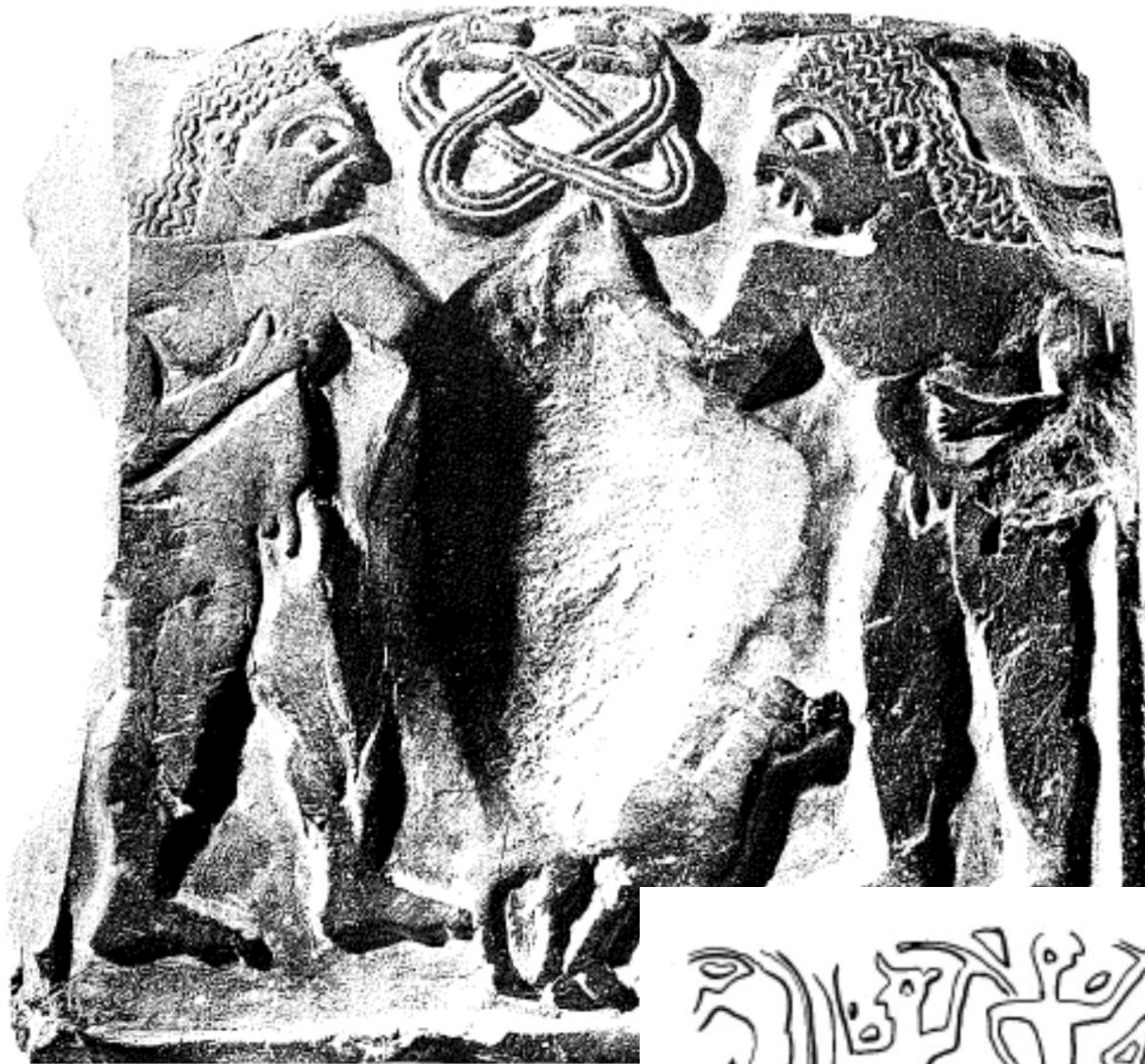

65. Suse. Relief en mastic de bitume. Epoque des d



5 10cm

c inscription sumérienne. Milieu du III^e mi



2

Impronta di sigillo Susa IV

Vase à la cachette (ca. 2500 a.C.), Susa

Il tesoro chiamato « le vase à la cachette » era originariamente raccolto dentro due contenitori con coperchio, ritrovato sull'acropoli di Susa. Il secondo vaso in ceramica era chiuso da un coperchio in rame. Ne è rimasto uno solo. Entrambi i vasi contenevano molti di oggetti tra cui sei sigilli, che vanno dall'epoca protourbana e protoelamita (3100-2750 a. C.) per i più antichi, mentre i più recenti possono essere datati intorno al 2450 a. C. 29 contenitori, di cui 11 in alabastro, uno specchio, utensili e armi in rame e bronzo, 5 basi di crogiuoli in rame, 4 anelli (3 in oro e uno in argento) una piccola figurina in lapis-lazuli, 9 vaghi in oro, 13 piccole pietre e un contenitore smaltato.



Vase à la cachette (ca. 2500 a.C.), Susa



Vase à la cachette (ca. 2500 a.C.), Susa



- Contenitore Smaltato



Lapislazzulo

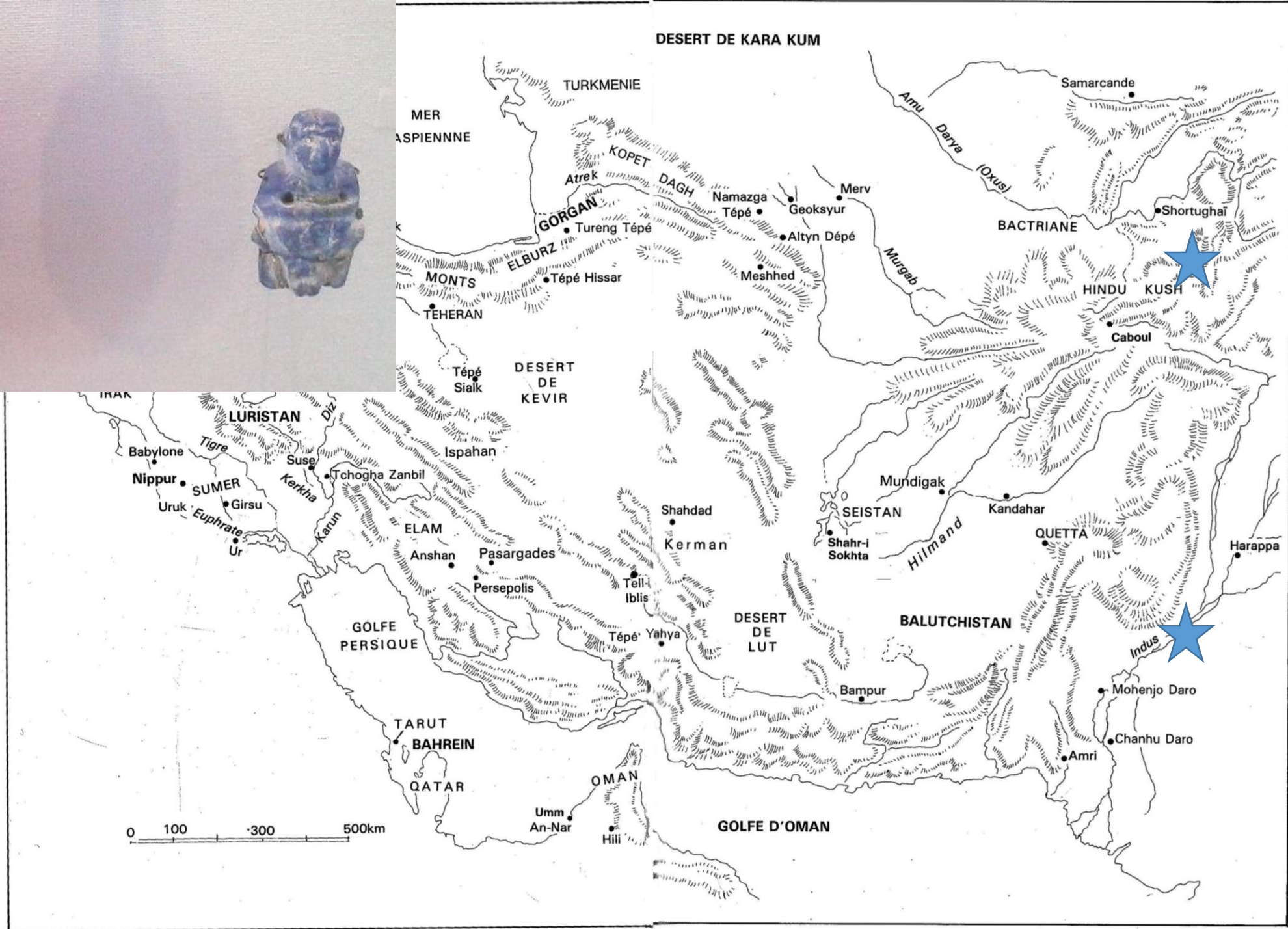

Vase à la cachette (ca. 2500 a.C.), Susa



Vasi in alabastro dal Seistan e dal deserto di Lut



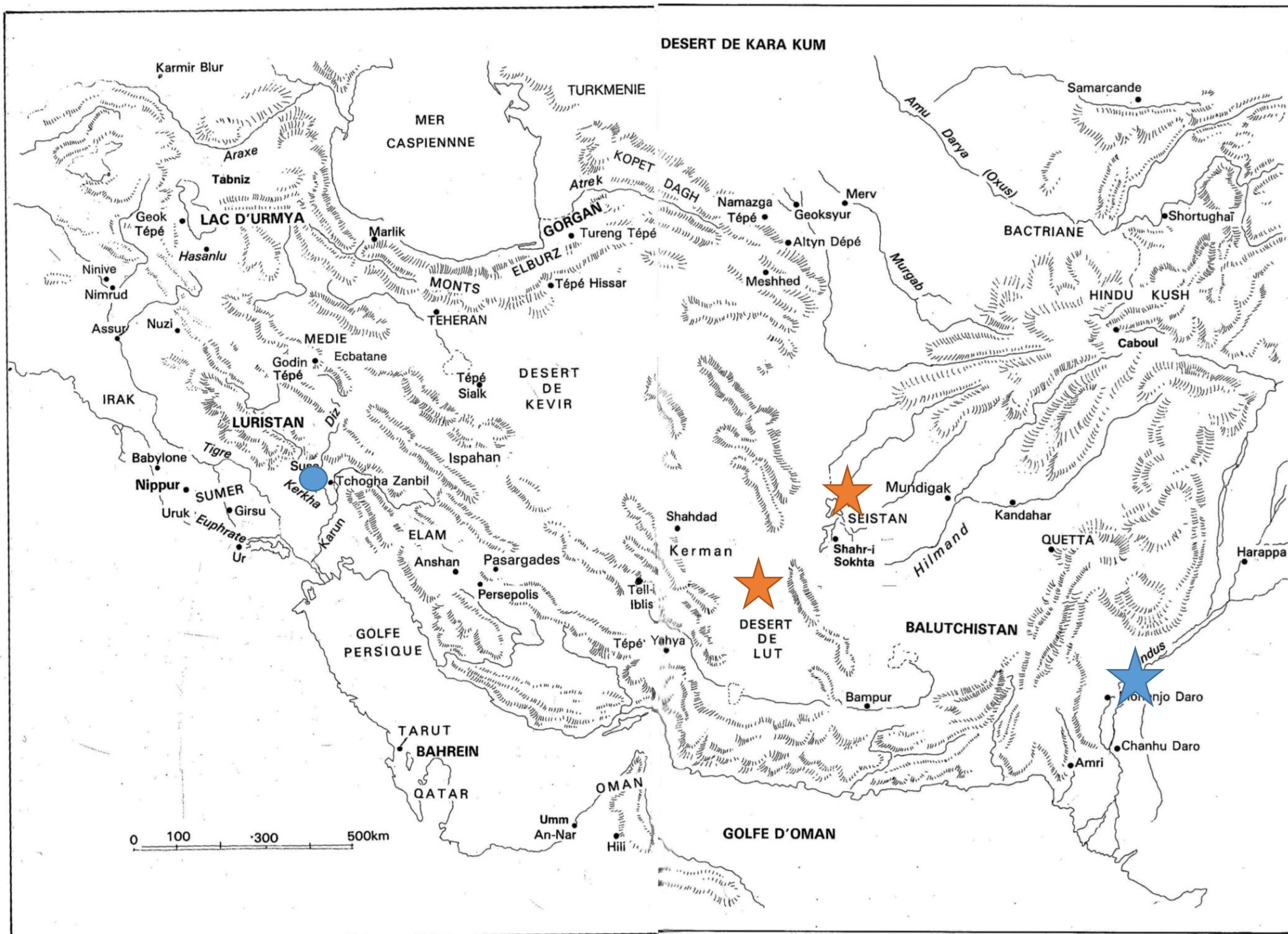

Vase à la cachette (ca. 2500 a.C.), Susa



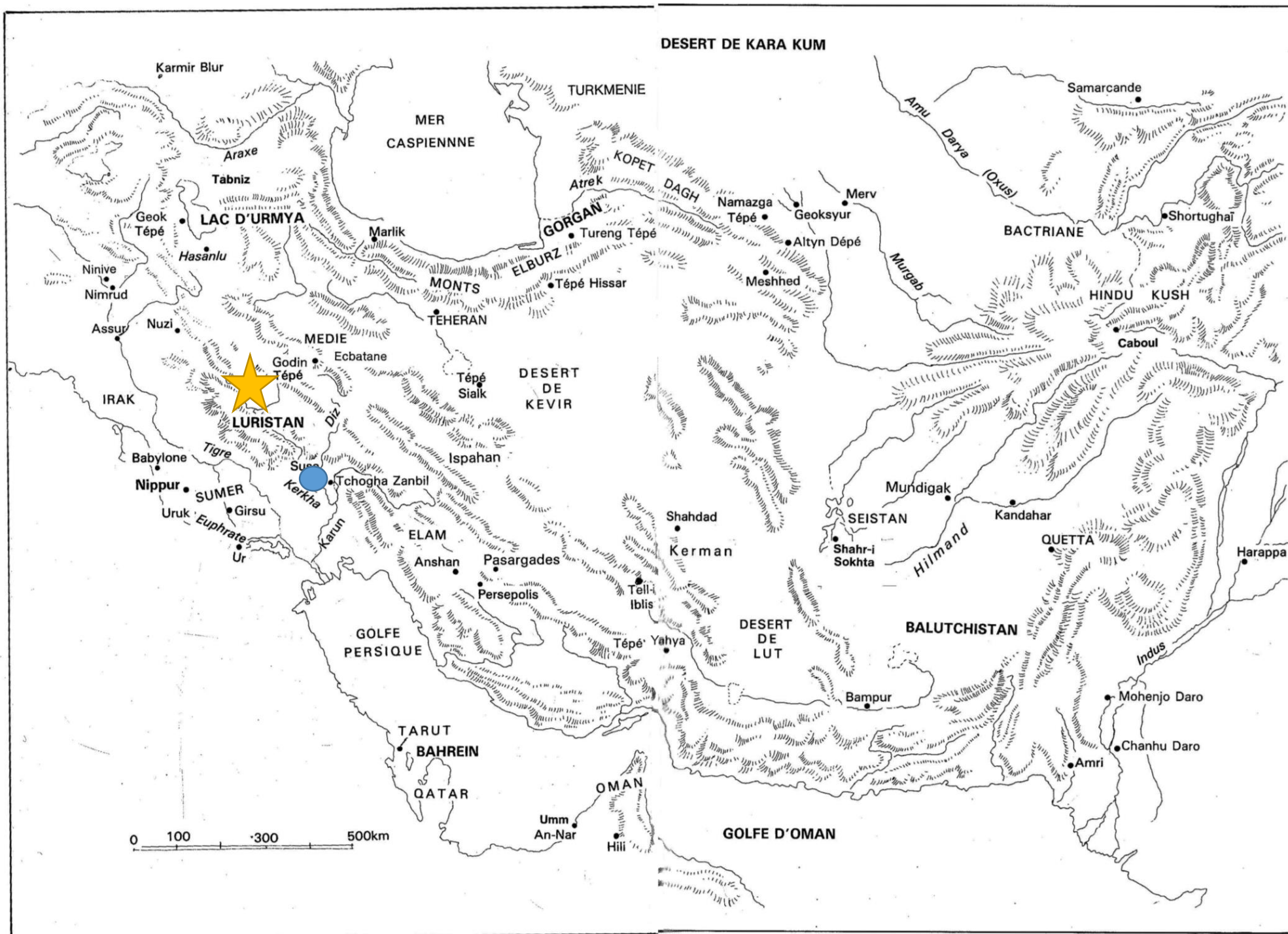

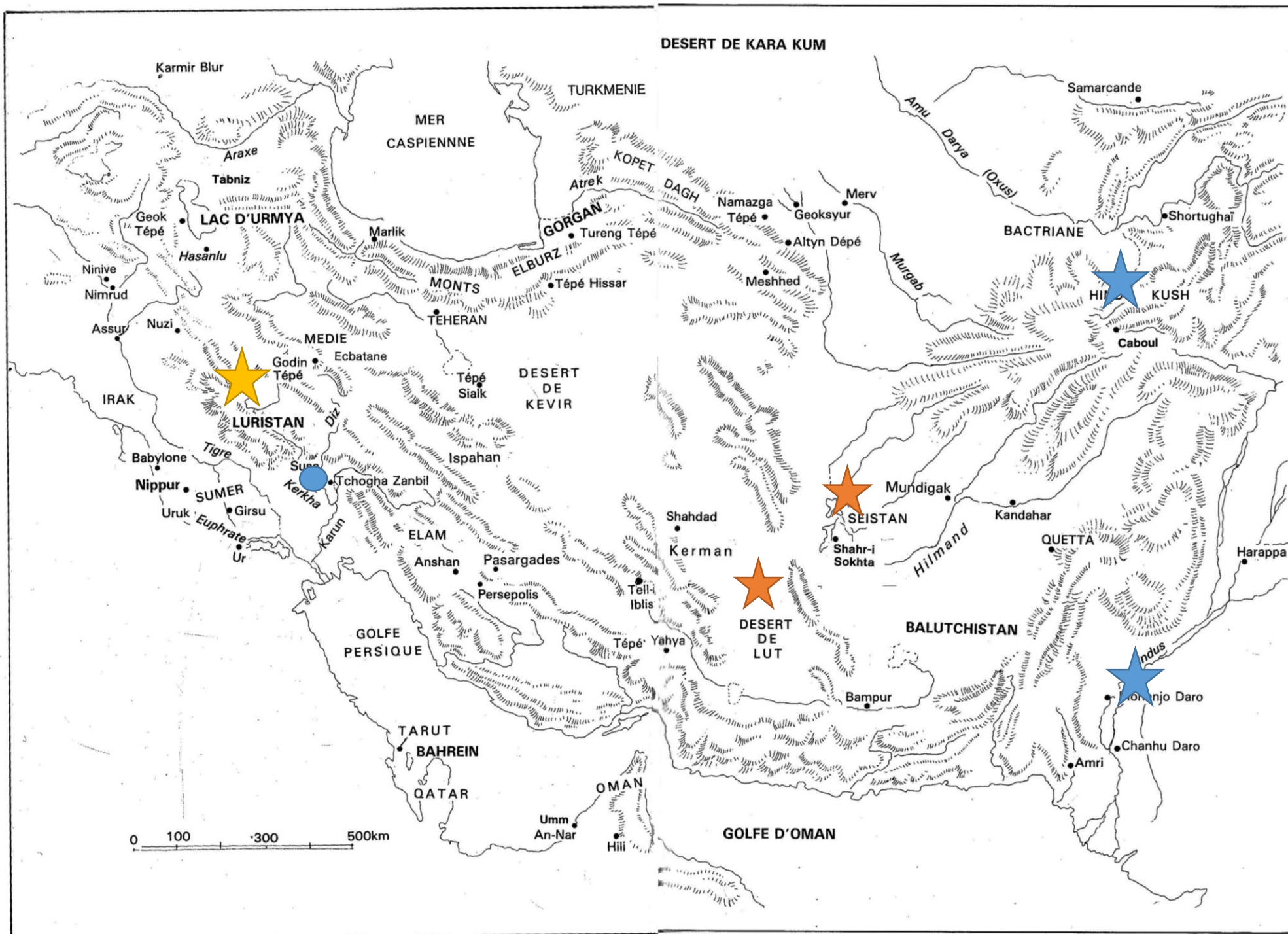

- Per quanto ancora a margine delle reti commerciali, una rete di scambi, in particolare per i materiali, viene messa in campo con le regioni vicine come l'Iran sud-orientale, i paesi del golfo, la valle dell'Indo



Godin Tepe

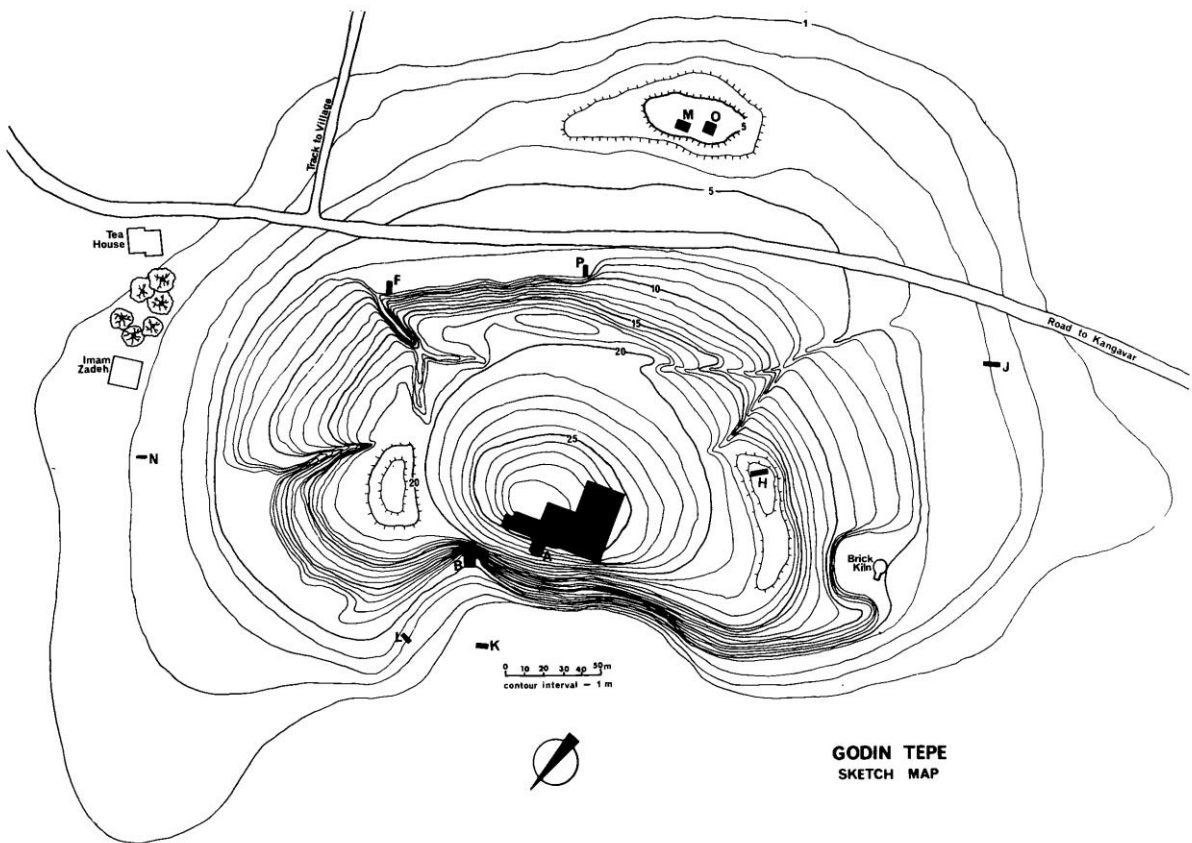
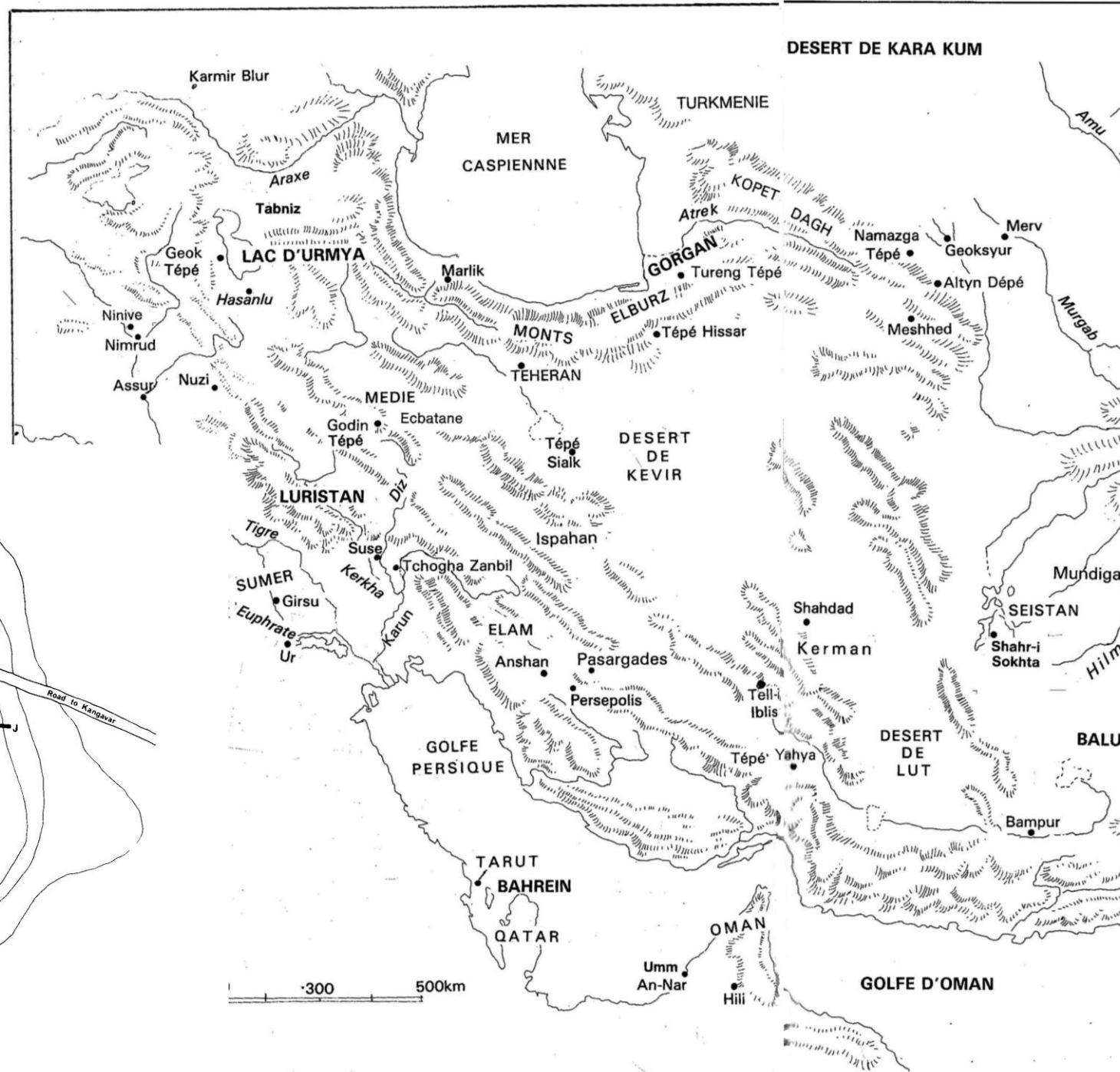

3 Topographic sketch map of Godin Tepe indicating areas excavated.

GODIN TEPE SKETCH MAP

Godin Tepe • Period V.

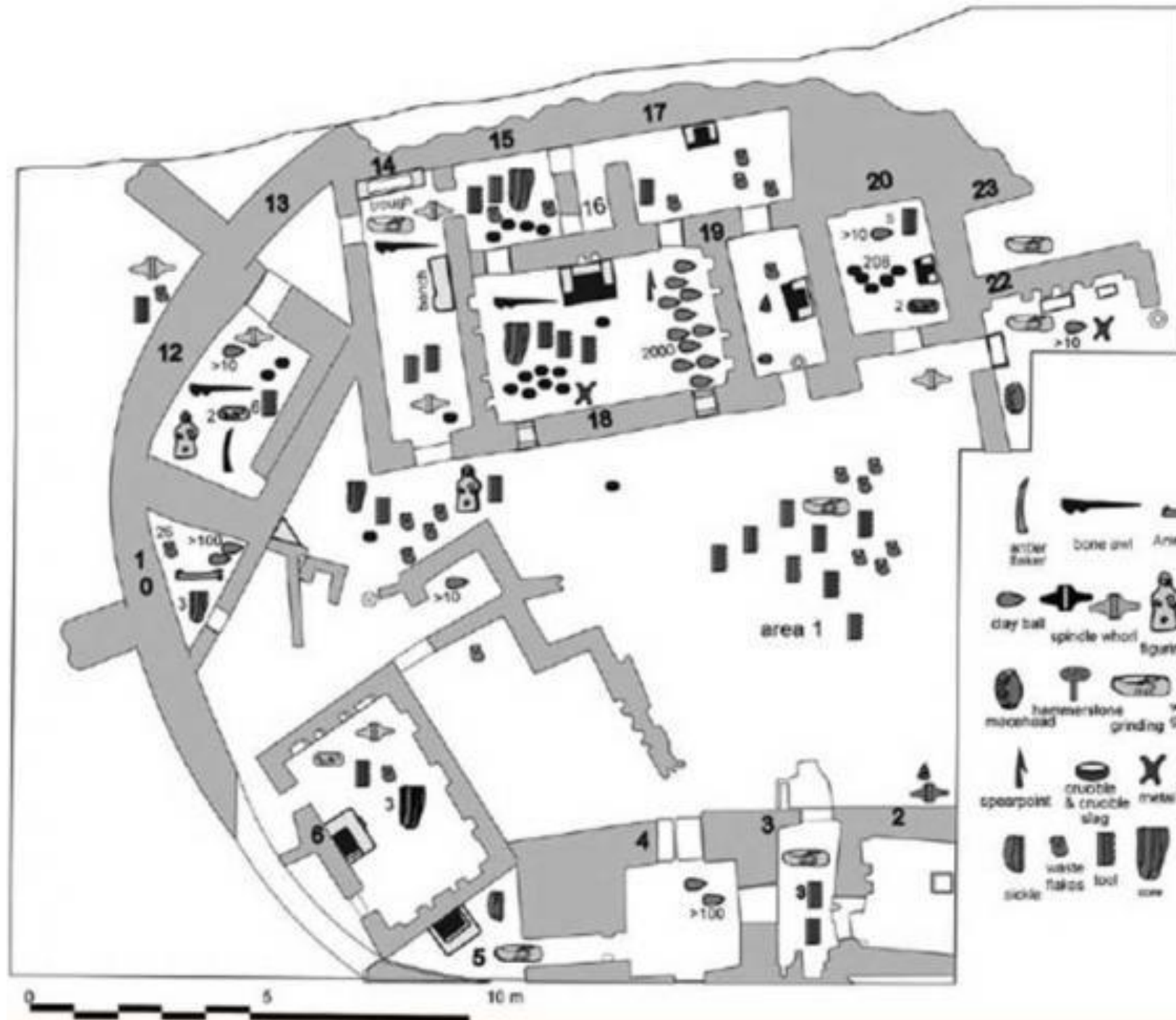

Data (a.C.)	Lowland	Highland	Mesopotamia
4300	Susa I	Tal-i-Bakun A III-IV	Ubaid III-IV
3800-3100	Susa II	Tal-i Bakun A (Lapui) Tal-i Malyan early Banesh.	Uruk medio e tardo
3100-2900	Susa III	Tal-i Malyan late Banesh Godin Tepe V-VI	Uruk Tardo/Jemed nasr
2900-2350	Susa IIIc, Susa IVa	Godin Tepe IV and III Abbandono di Tal-i Malyan	Protodinastico I-III

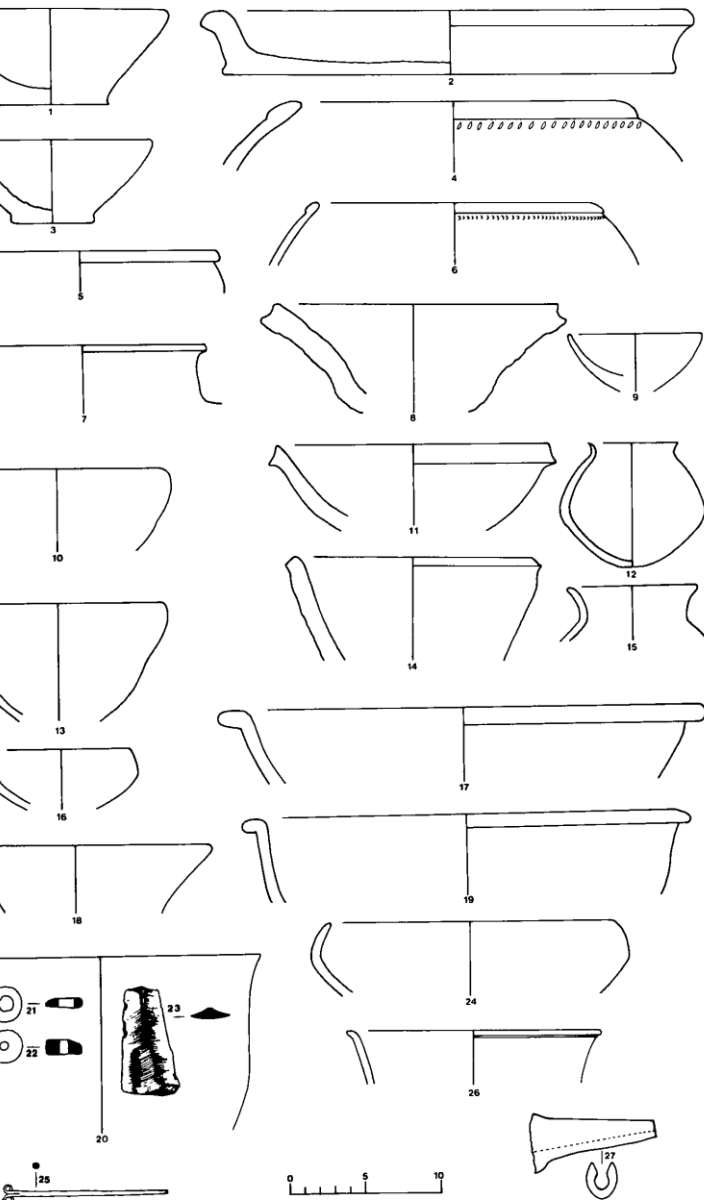

Period V pottery and small finds.

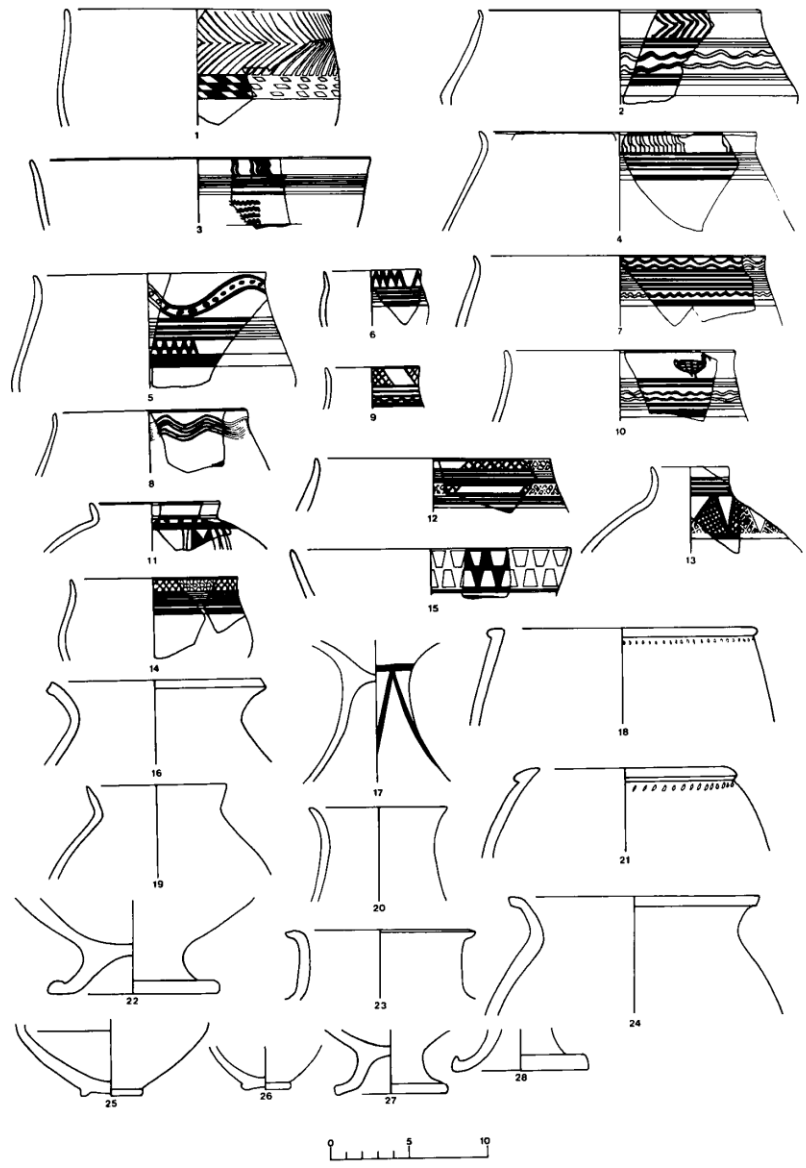
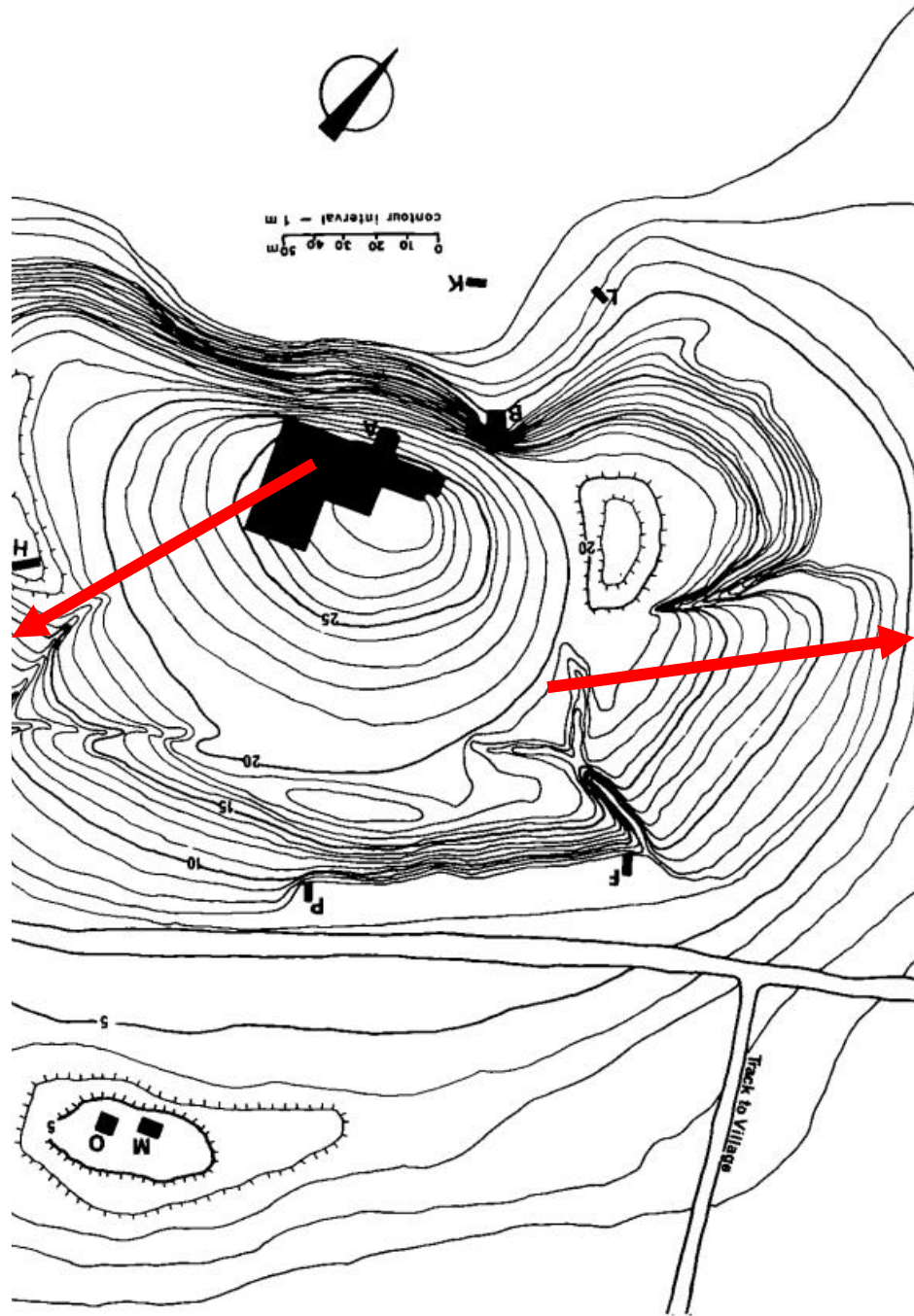

7 Period VI pottery.

Godin Tepe

- **Period IV.** Exposed over about 500 m² it represents a major incursion from the north into the central western Zagros of the Transcaucasian Early Bronze I culture (best identified in Iran at Yānik Tepe in Azerbaijan). At Godin this phase yielded village houses, elaborate ceremonial open air-structures on the then summit of the mound, and an industrial area (metal working?). The “invasion” of this culture from the north is probably responsible for the abandonment of the Period V oval enclosure, since it would have completely disrupted east-west trade along the Khorasan Road. Dates for Period IV are around 3000-2650 B.C.E.

Data (a.C.)	Lowland	Highland	Mesopotamia
4300	Susa I	Tal-i-Bakun A III-IV	Ubaid III-IV
3800-3100	Susa II	Tal-i Bakun A (Lapui) Tal-i Malyan early Banesh. Godin Tepe V	Uruk medio e tardo
3100-2900	Susa III	Tal-i Malyan late Banesh Godin Tepe V	Uruk Tardo/Jemed nasr
2900-2350	Susa IIIc, Susa IVa	Godin Tepe IV and III Abbandono di Tal-i Malyan	Protodinastico I-III

Godin Tepe IV

Data (a.C.)	Lowland	Highland
2900-2350	Susa IIIc, Susa IVa	Godin Tepe IV and III Abbandono di Tal-i Malyan

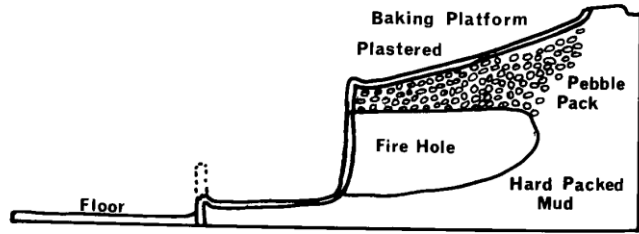
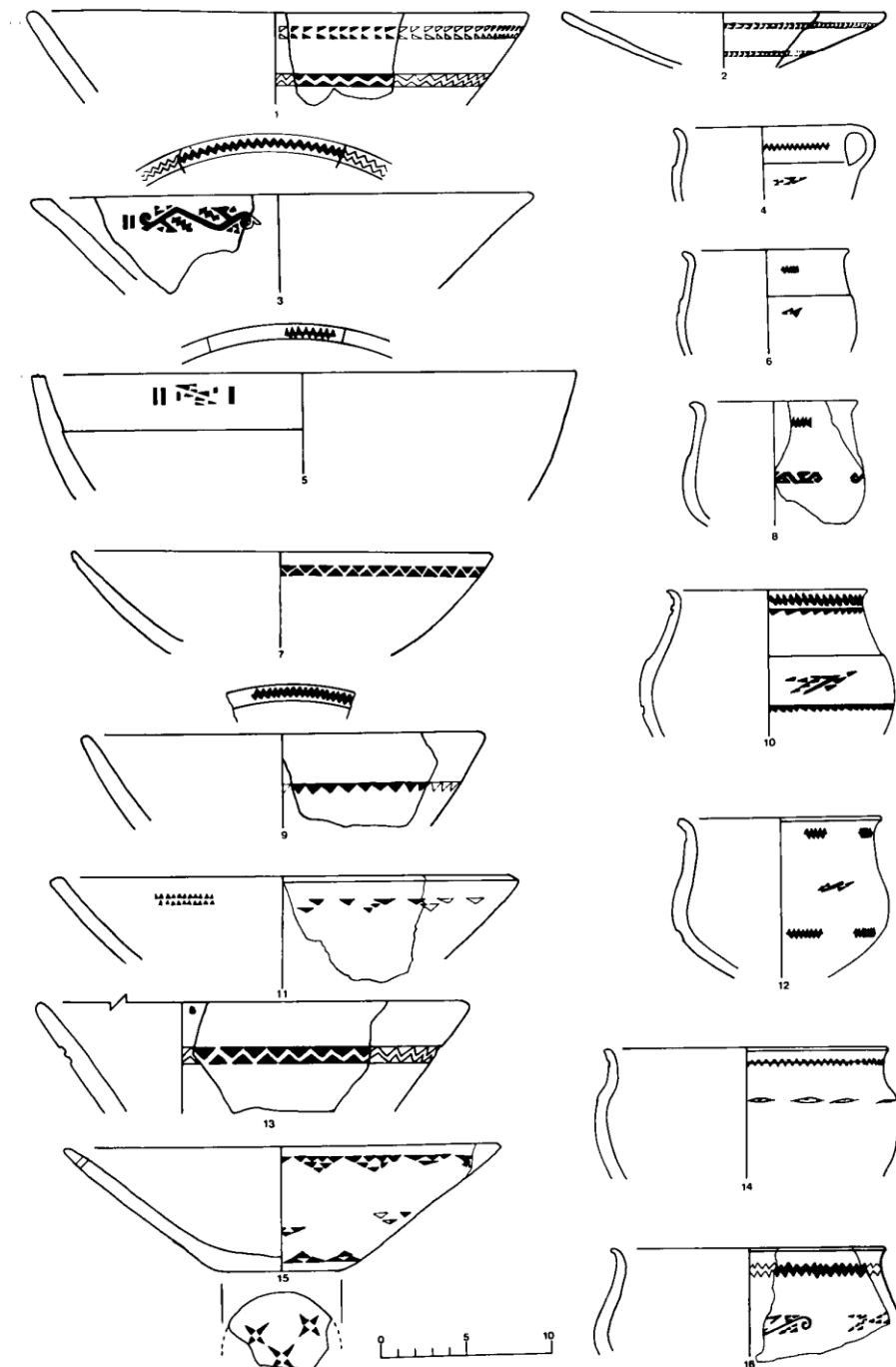
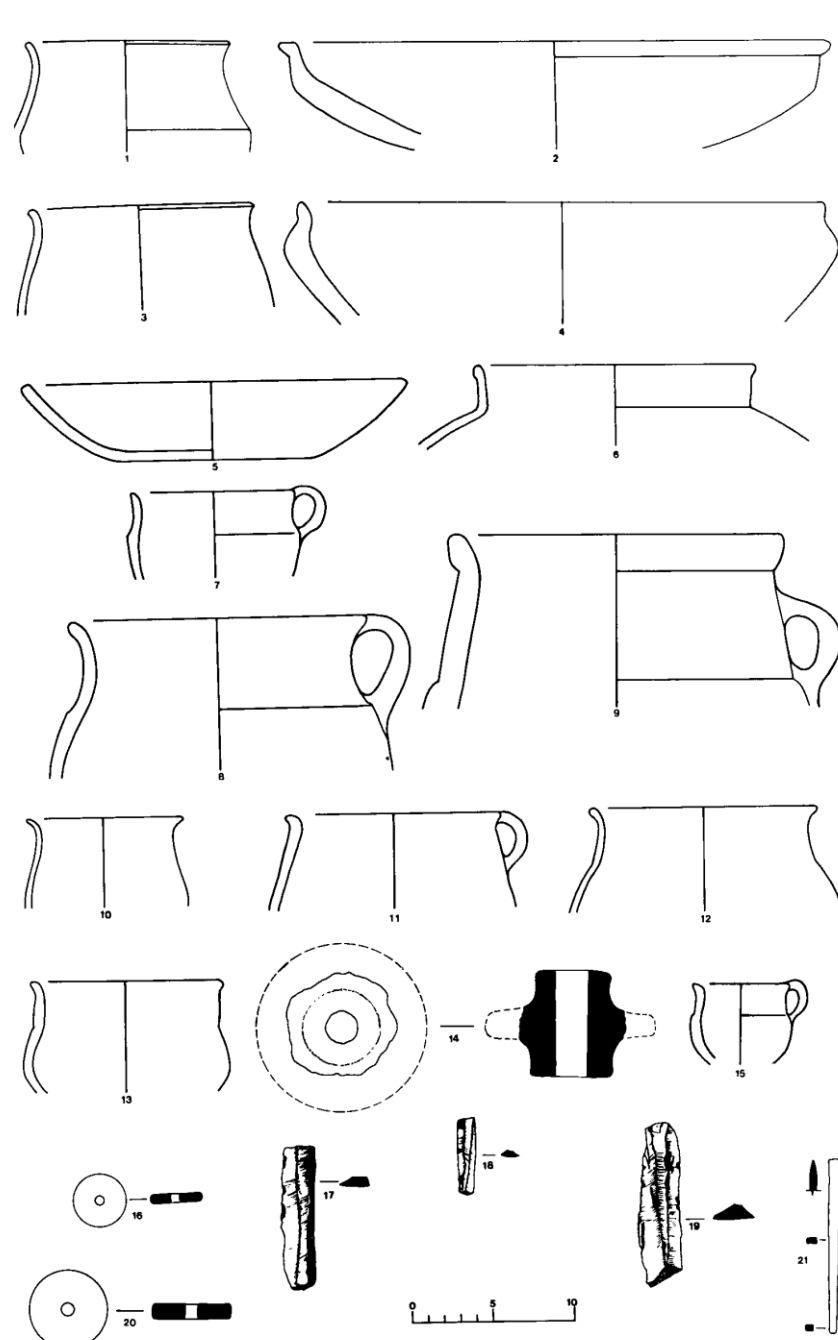

GODIN TEPE - 1965
OP. B - STRATUM 10
HEARTH SECTION
0 10 20 cm

12 Period IV pottery and small finds.

11 Period IV pottery.

10 Period IV, hearth, plan and elevation.

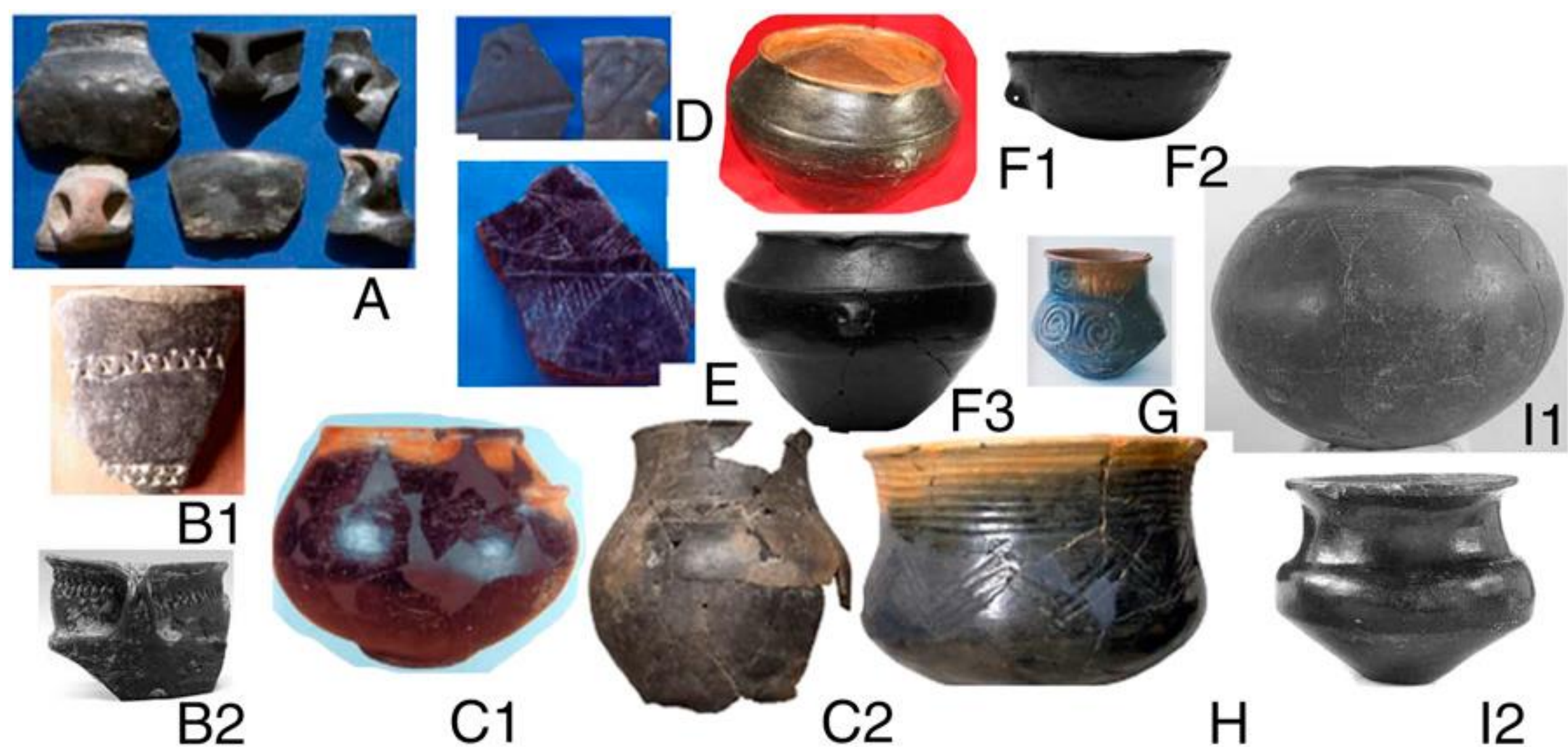

Sample of Kura-Araxes pottery styles. Early Bronze Kura-Araxes: (A) Ravaz (north of Lake Urmia), (B1 and B2) Godin Tepe level IV, (C1 and C2) central western Zagros and Arslantepe (Malatya Plain), (D) Dimple and Line (Mus, Plain), (E) Georgian, (F1–F3) Shengavit (Ararat foothills), (G) Karaz (Erzurum), and (H) Khirbet Kerak (Galilee littoral). Middle Bronze Bedeni/early Trialeti: (I1 and I2) Sos Höyük level IVA, Erzurum

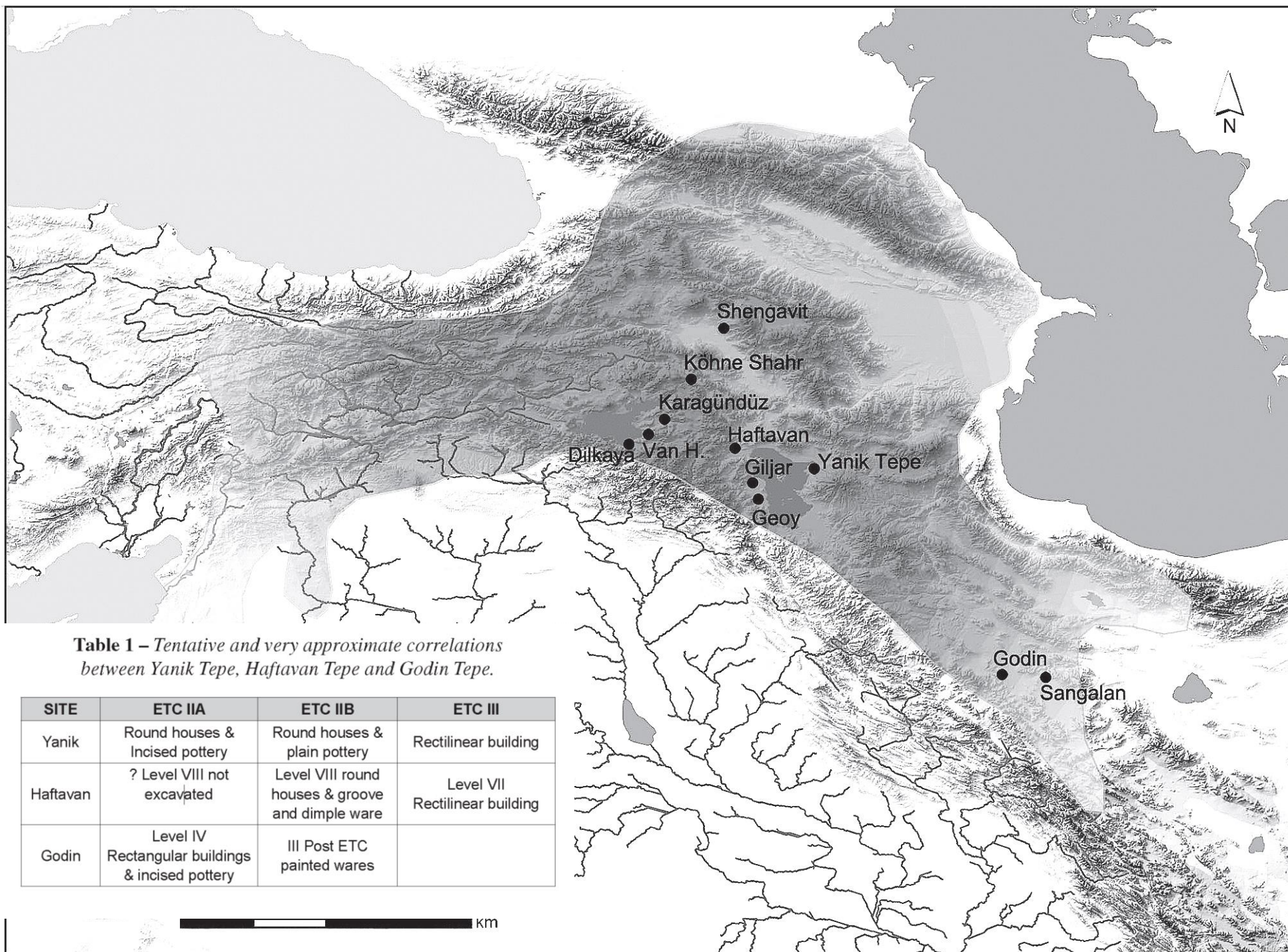

Table 1 – Tentative and very approximate correlations between Yanik Tepe, Haftavan Tepe and Godin Tepe.

SITE	ETC IIA	ETC IIB	ETC III
Yanik	Round houses & Incised pottery	Round houses & plain pottery	Rectilinear building
Haftavan	? Level VIII not excavated	Level VIII round houses & groove and dimple ware	Level VII Rectilinear building
Godin	Level IV Rectangular buildings & incised pottery	III Post ETC painted wares	



Yanik Tepe ETC II decorated pottery: bowl with white-filled excised and incised patterning; jar with incised motifs





FIGURE 9.1 *Distribution of Kura-Araxes cultural tradition* (DRAWING BY M.S ROTHMAN).

Godin Tepe

Data (a.C.)	Lowland	Highland	Mesopotamia
4300	Susa I	Tal-i-Bakun A III-IV	Ubaid III-IV
3800-3100	Susa II	Tal-i Bakun A (Lapui) Tal-i Malyan early Banesh. Godin Tepe V	Uruk medio e tardo
3100-2900	Susa III	Tal-i Malyan late Banesh Godin Tepe V	Uruk Tardo/Jemed nasr
2900-2350	Susa IIIc, Susa IVa	Godin Tepe IV and III Abbandono di Tal-i Malyan	Protodinastico I-III

- Period III. Exposed over an average of 700 m² it is an uninterrupted sequence for some 11 m of Bronze Age occupation. Six sublevels are identified stratigraphically and by distinct changes in both painted and plain ceramics. At least one sublevel (III:2) was destroyed by earthquake. At this time Godin was the largest site in the valley, which was quite densely occupied, and may be called a town, since pottery was manufactured in centralized workshops and meat was sold from butcher shops.

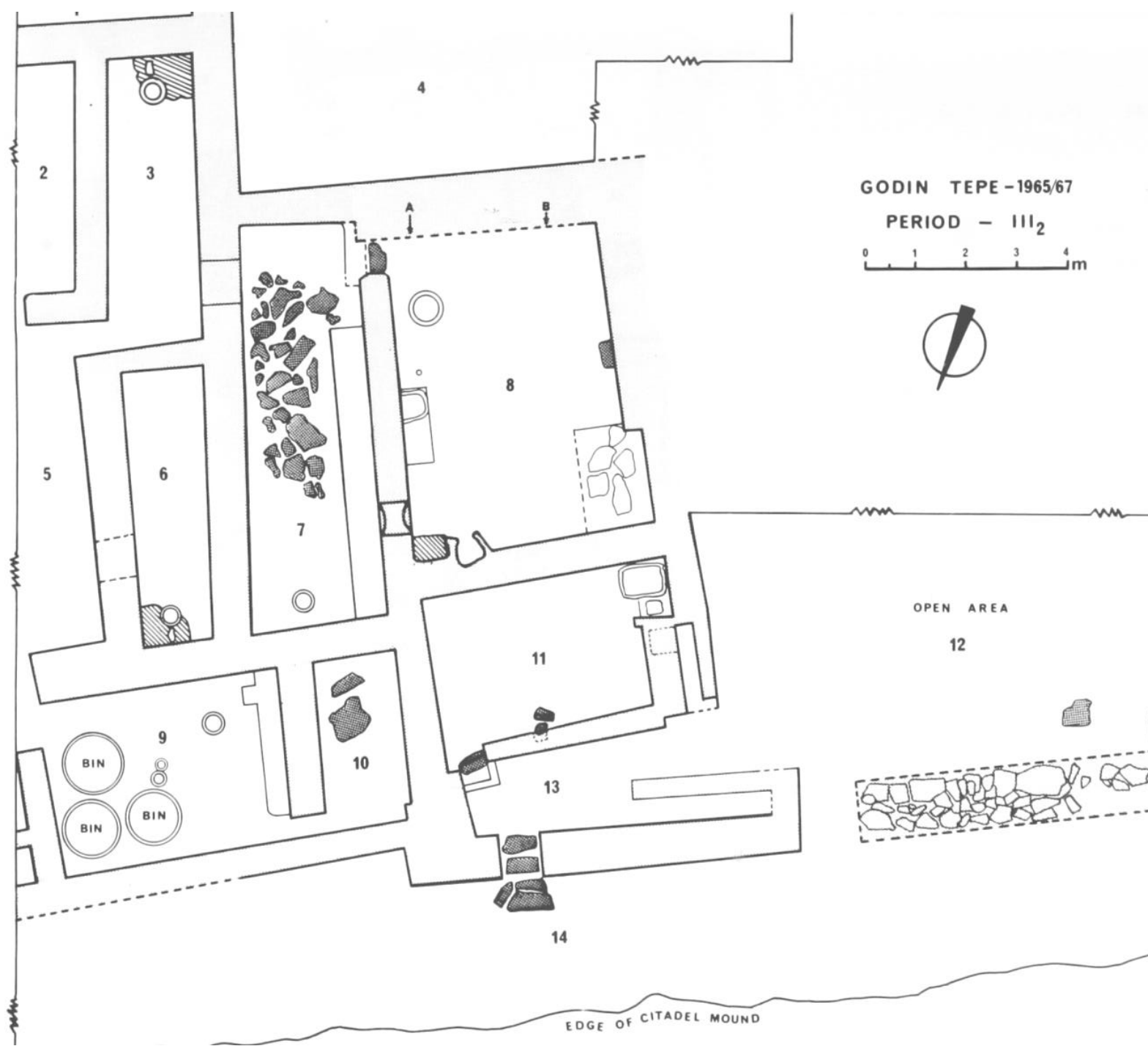
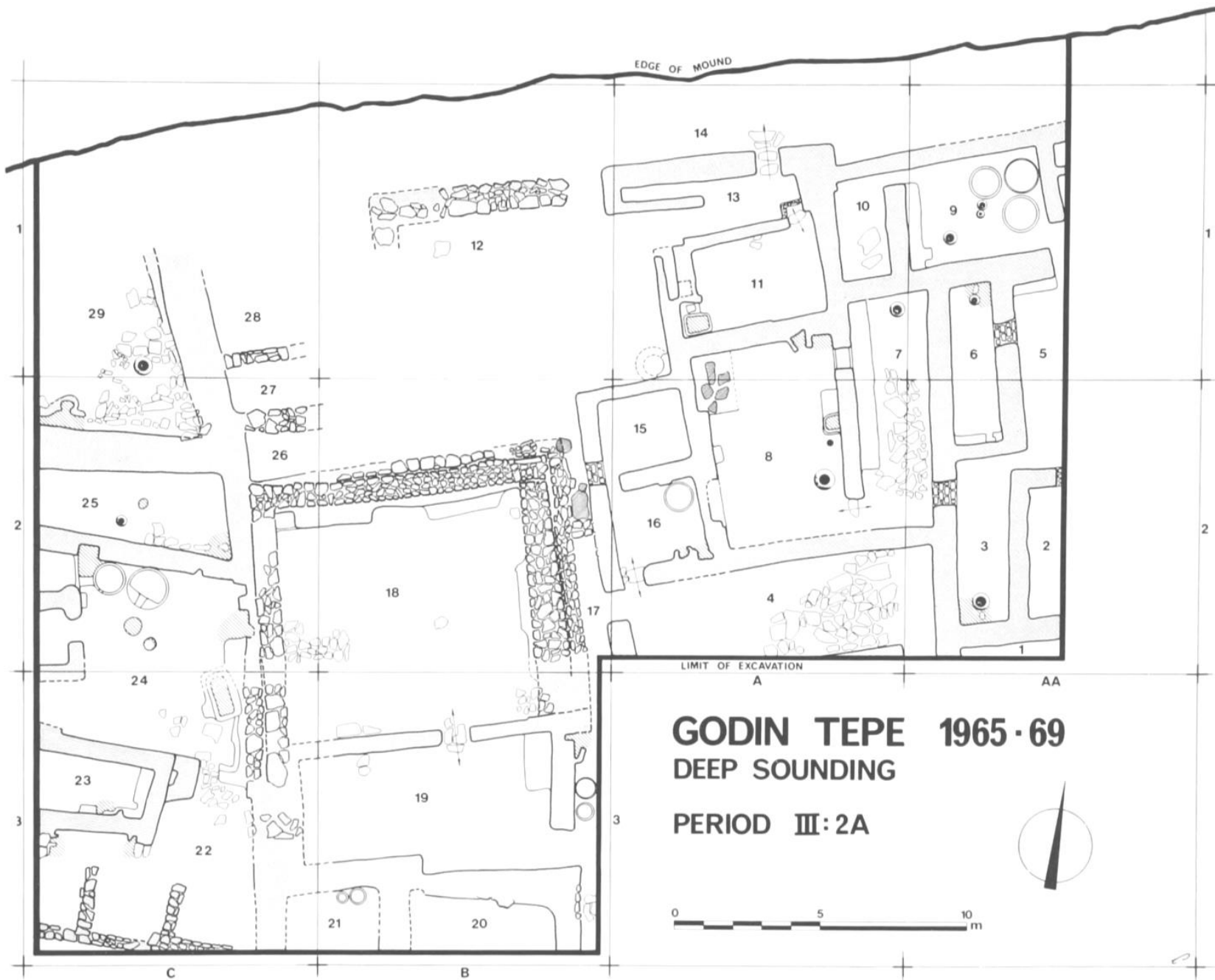
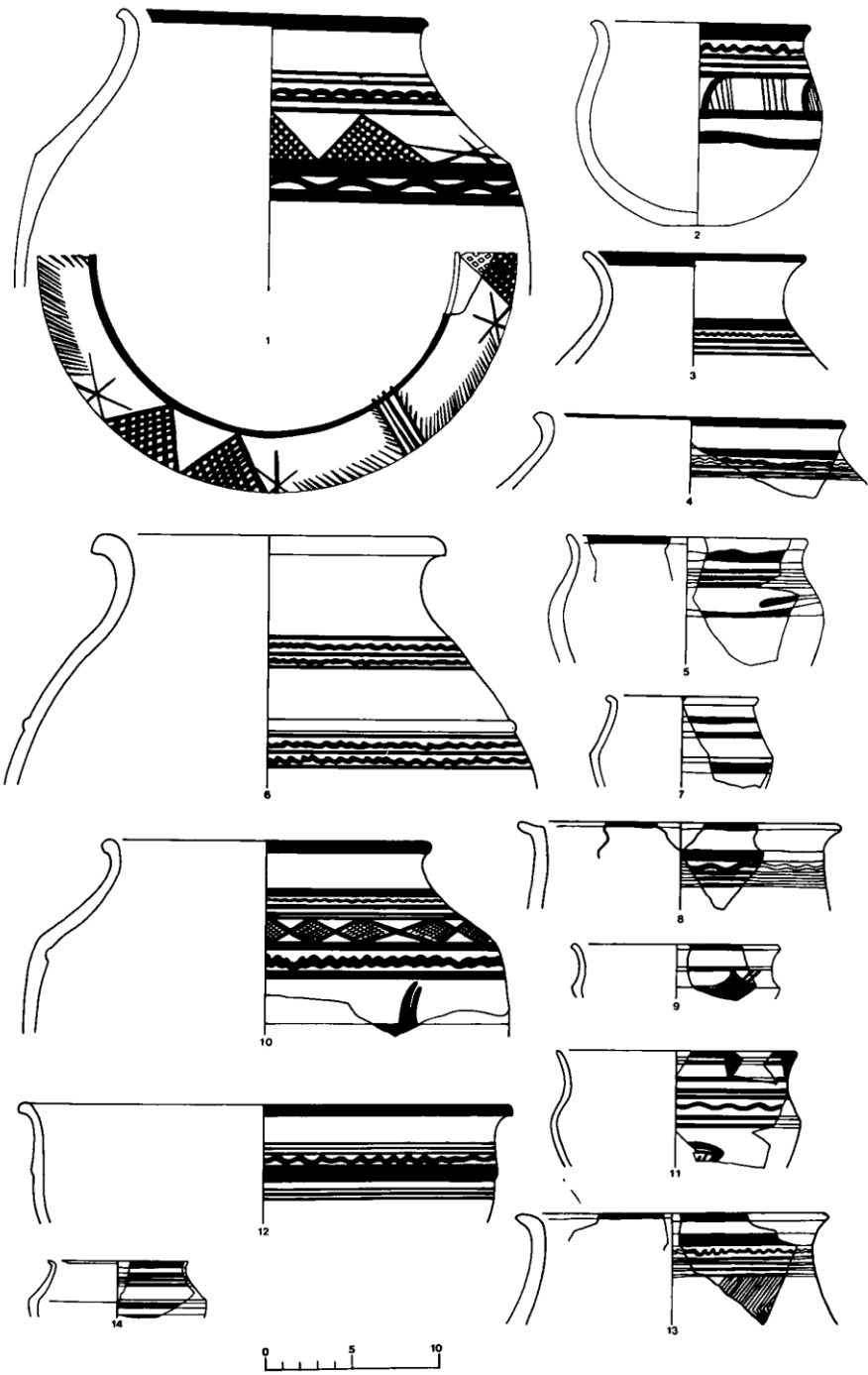
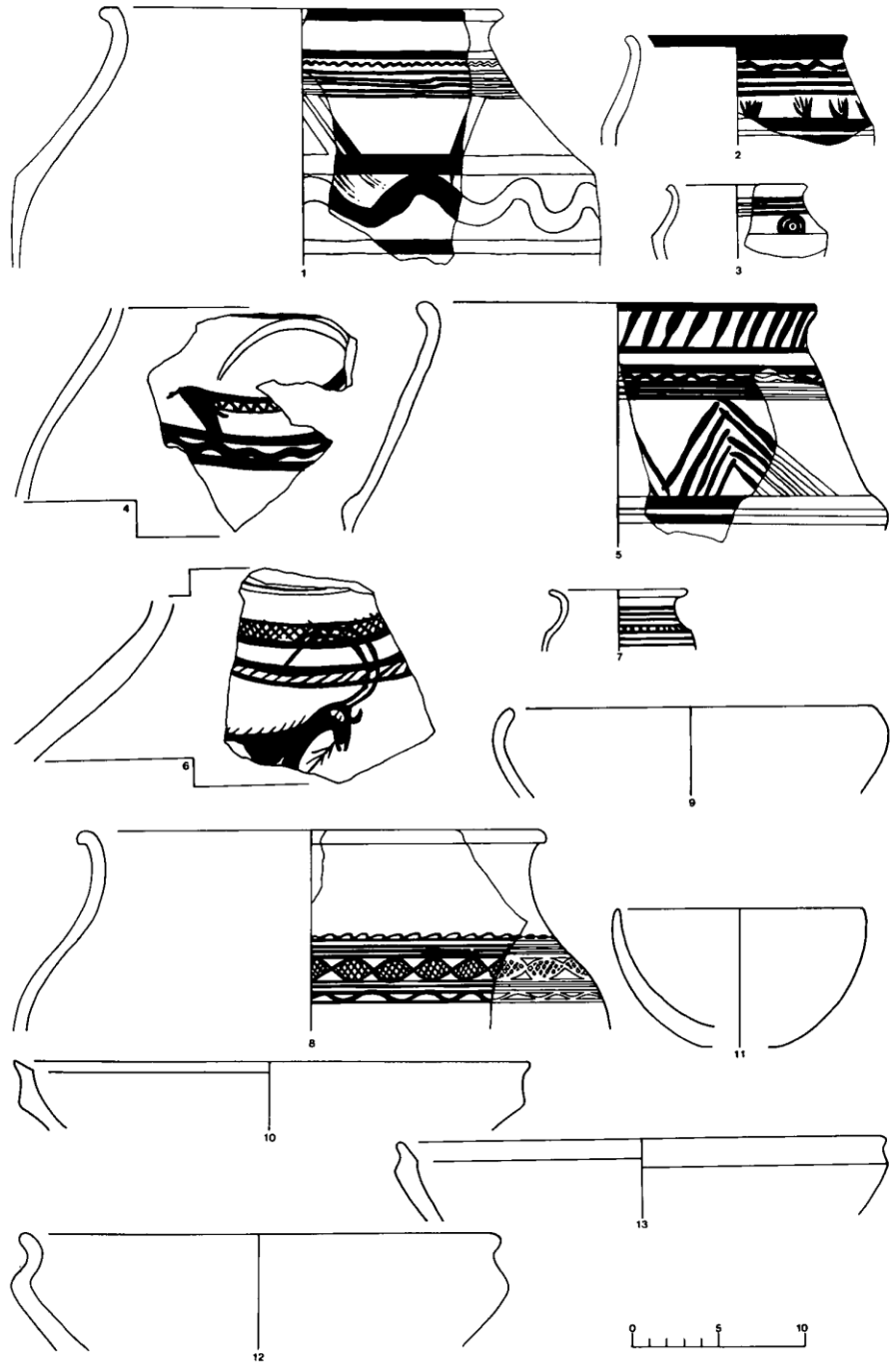

Plate V: Remains of mud plaster storage bins and two cooking vessels on the floor in the northeast corner of room 9, Level III₂.





17 Period III pottery: sherds.



18 Period III pottery: sherds.

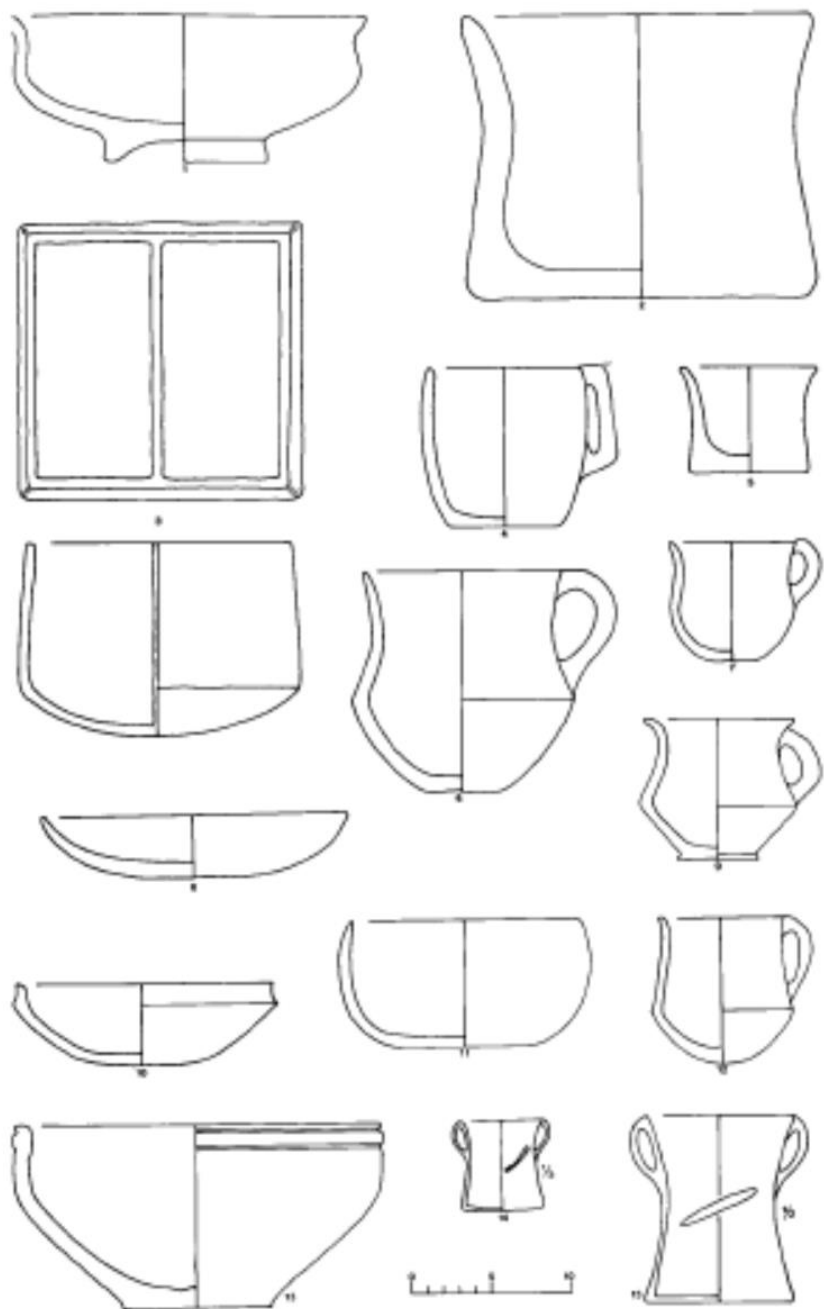

23 Period III pottery.

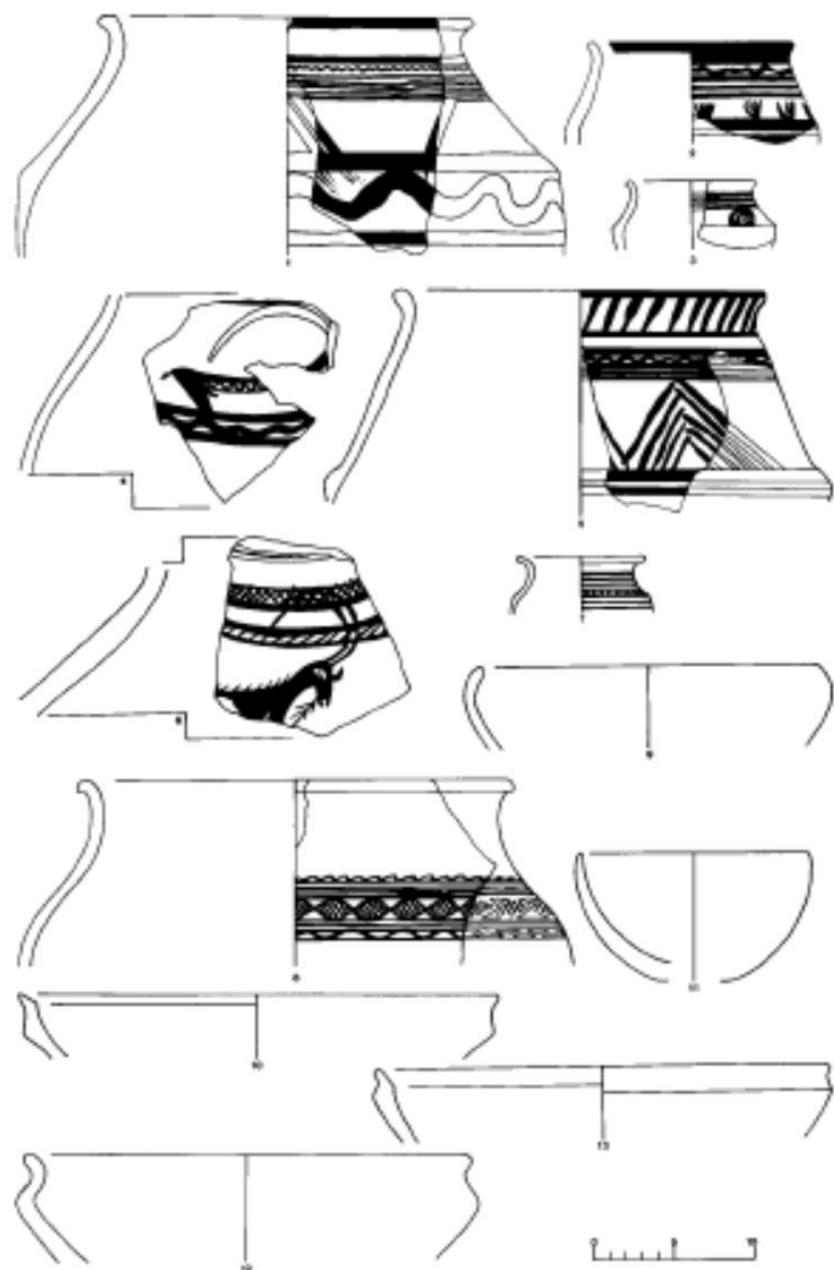

18 Period III pottery: sherds.

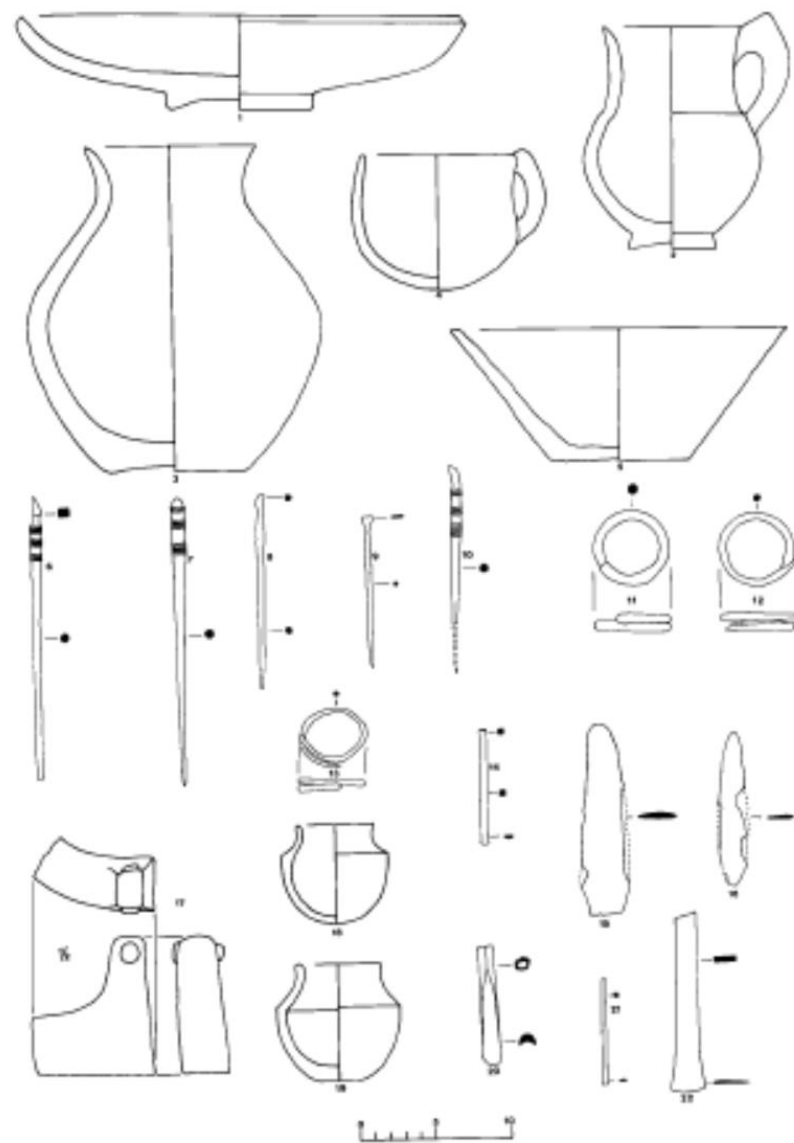

21 Period III pottery and small finds.



Plate XV: Typical inhumation of Period III: Operation M1, Burial 5 (v. also Fig. 26).

Godin Tepe III, cimitero

All of the Period III burials in the cemetery were flexed, lying either on their right or left sides. They displayed no consistent pattern of orientation. All were laid in simple grave cuts, usually oval in plan and rarely much larger than was needed to take the body and its grave goods. Grave offerings were either at the foot or, more usually, the head of the body, and sometimes at both foot and head. Often, but not always, joints of meat were included among the grave goods, and offerings varied in richness from grave to grave.

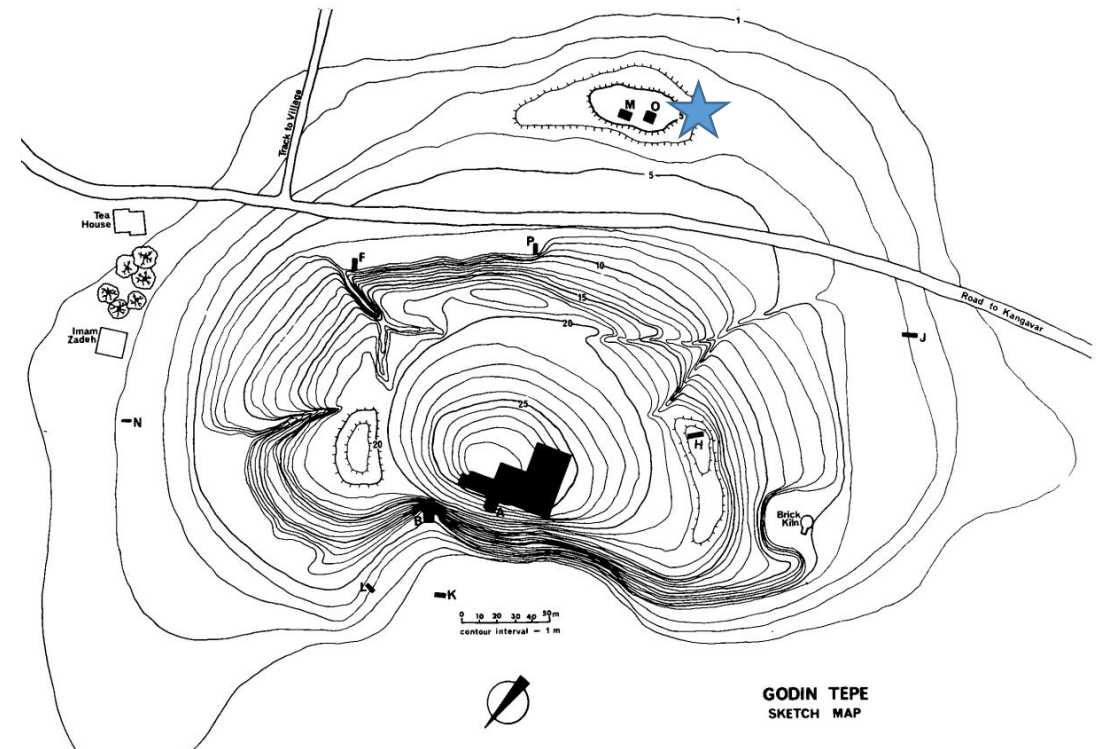

GODIN TEPE
SKETCH MAP

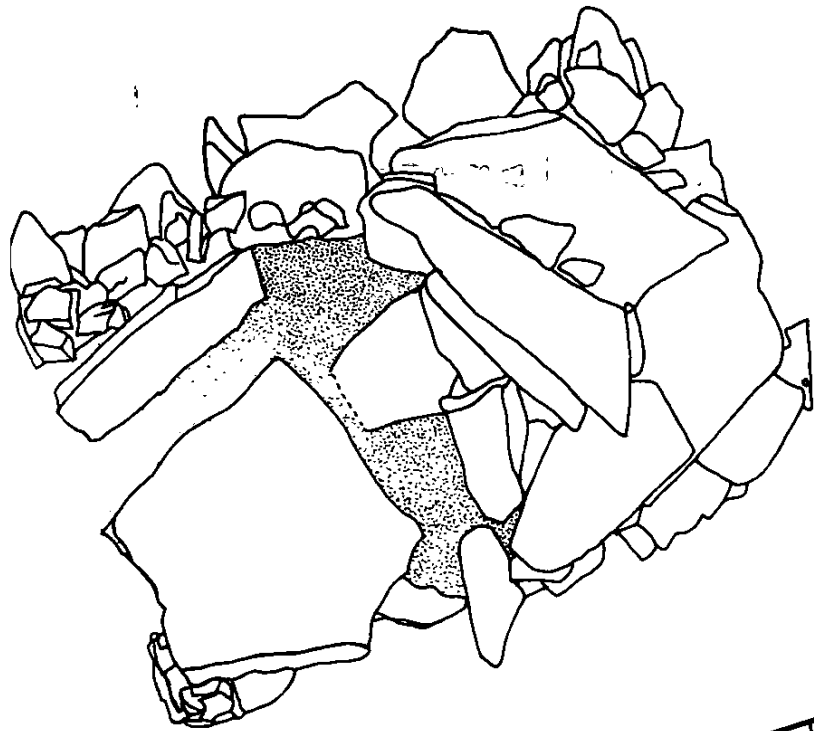

Plan

GODIN TEPE - 1967

OP. O - TOMB I

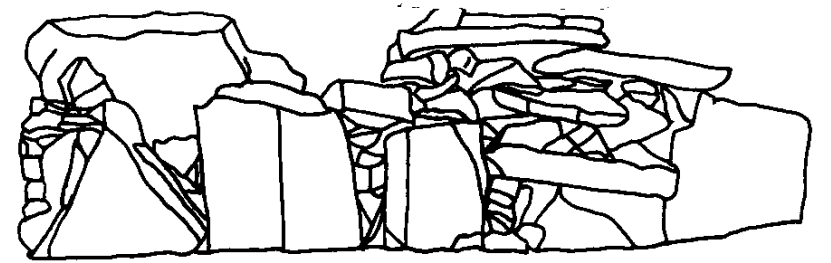
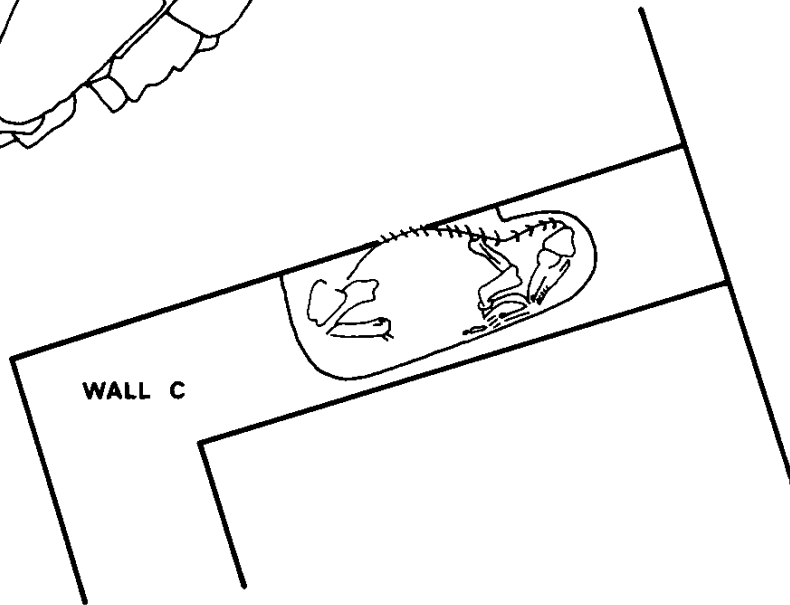
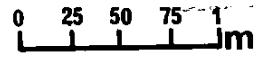

Elevation - North Side

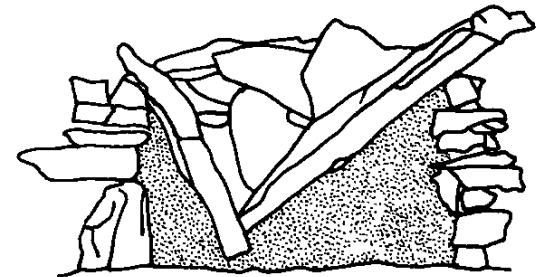

Elevation - East End

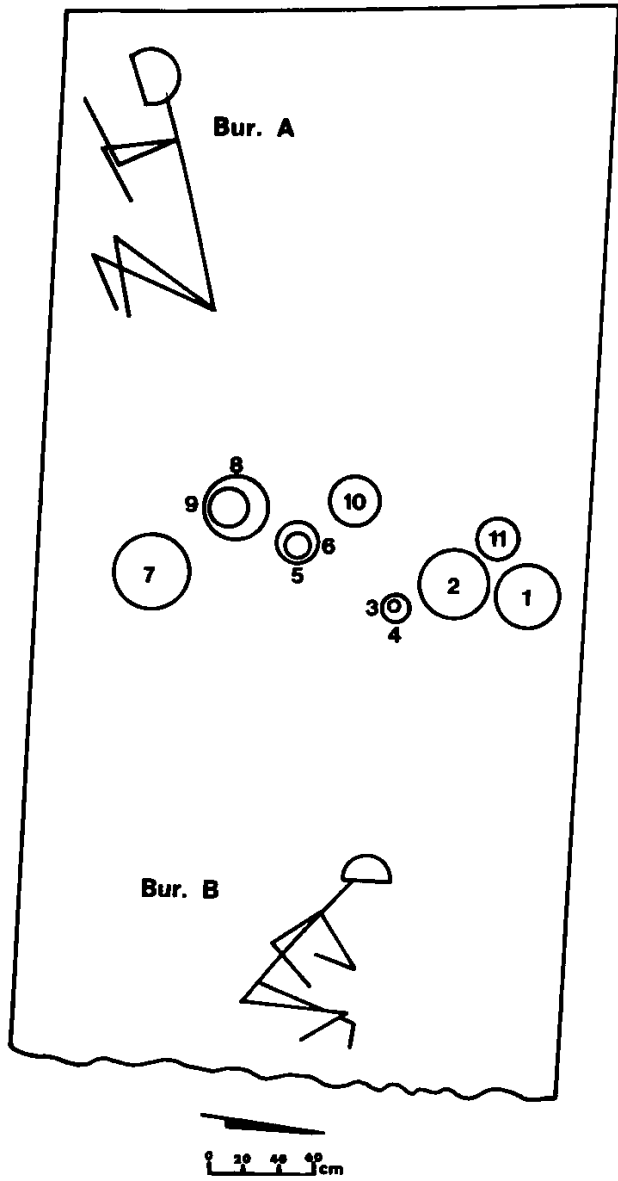
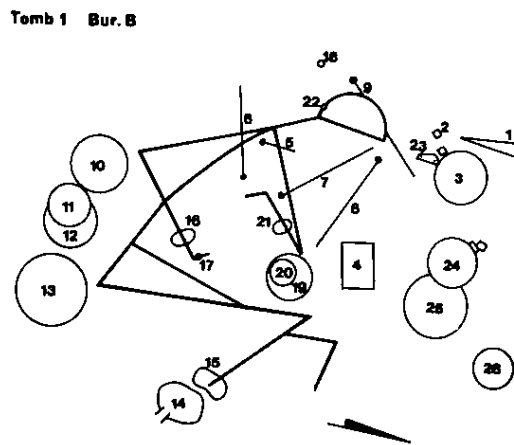
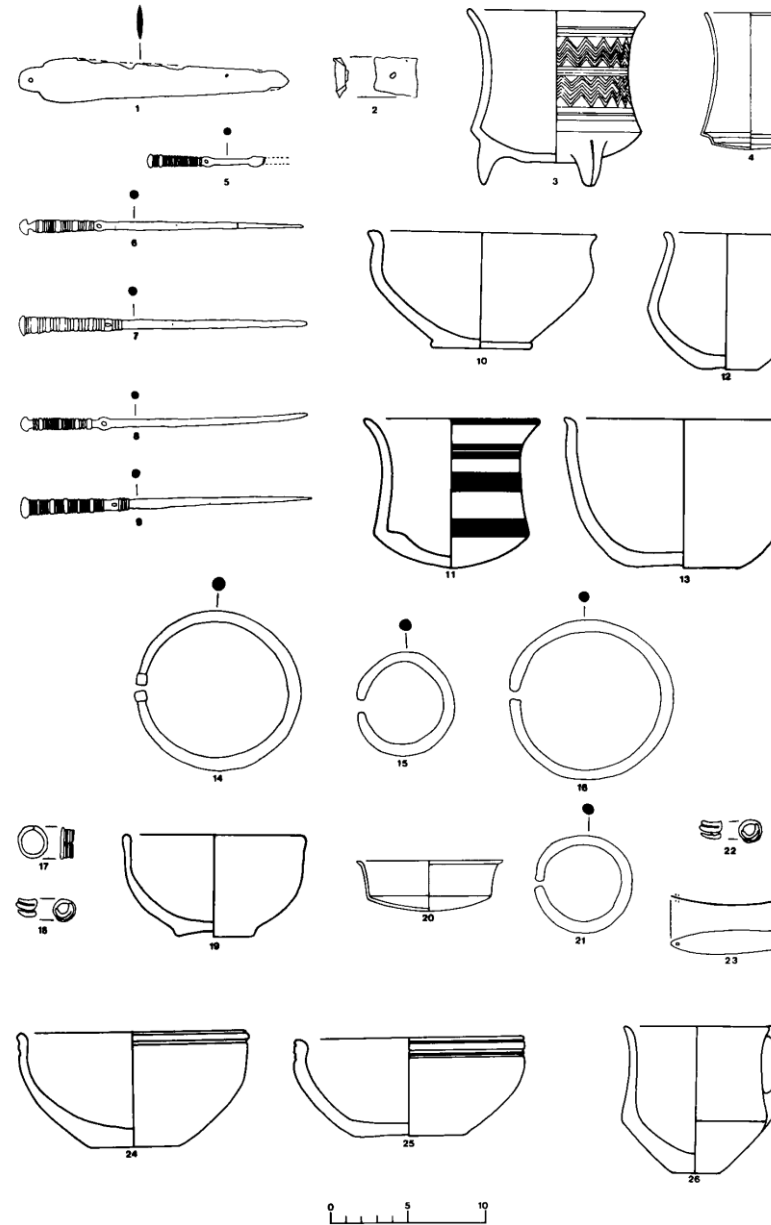

Plate XVI: Period III tomb, unopened: view from northwest corner. Hind legs of the horse skeleton visible in the bottom left corner.



Bur. A



30 Period III tomb, Burial B grave goods.

29 Period III tomb, detailed plans of Burials A and B.

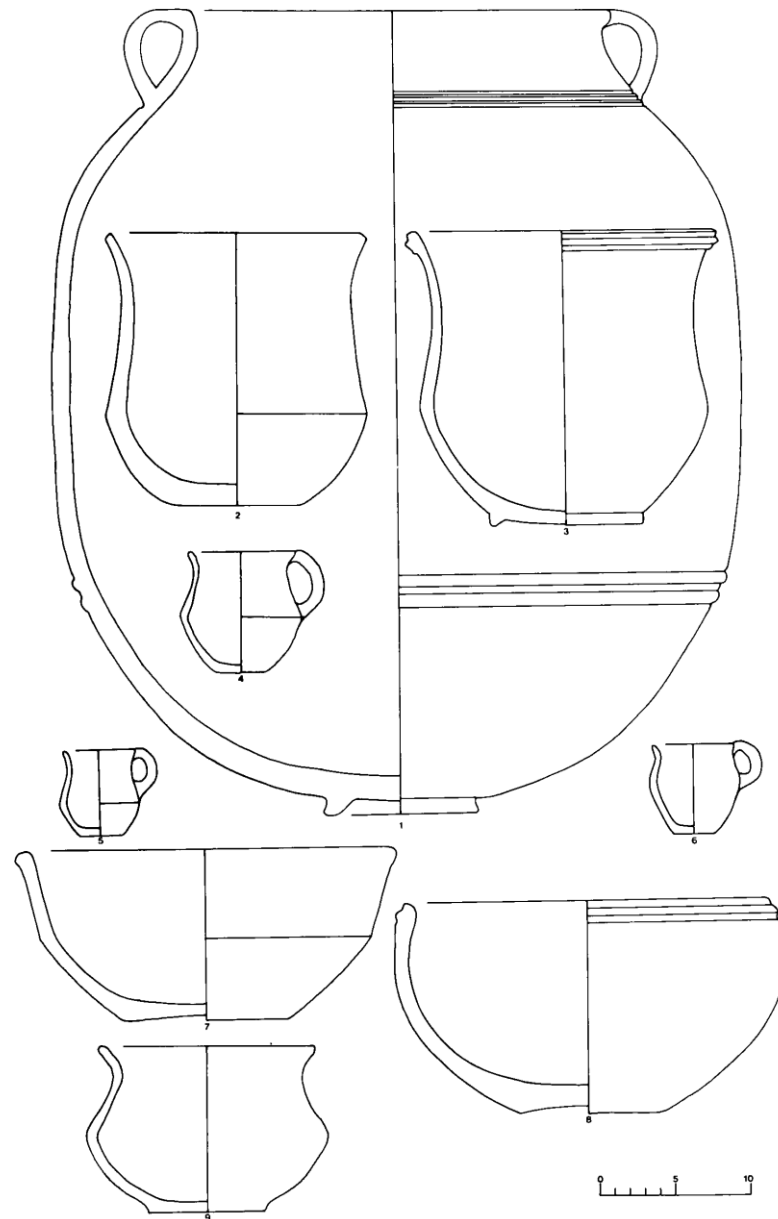
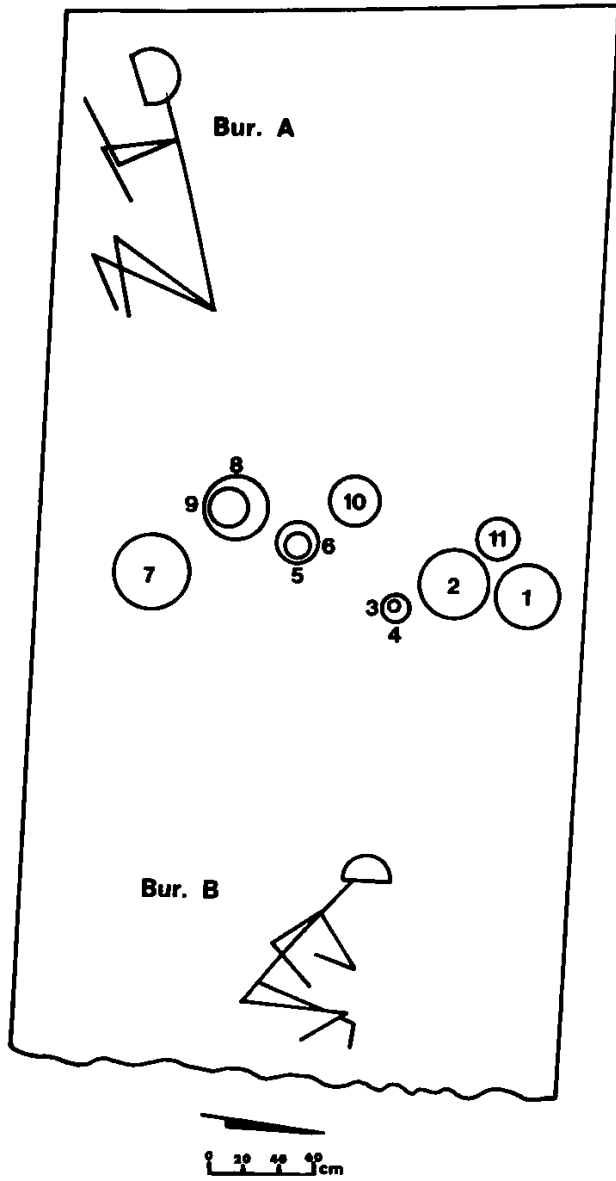

32 Period III tomb, central grave offering and objects from outside tomb.



Plate XVII: Period III tomb, opened: central grave offering *in situ* on the floor of the tomb.

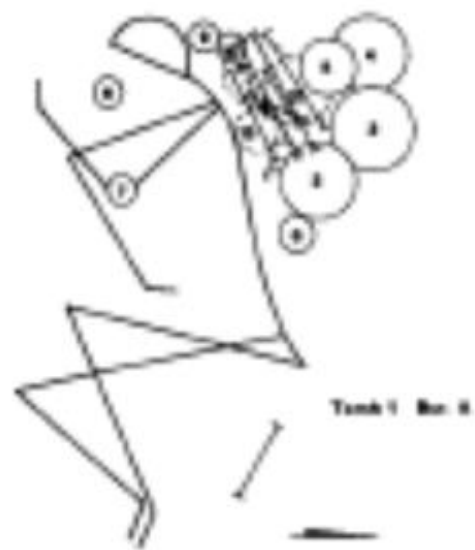

Tomb 1 Bur. B

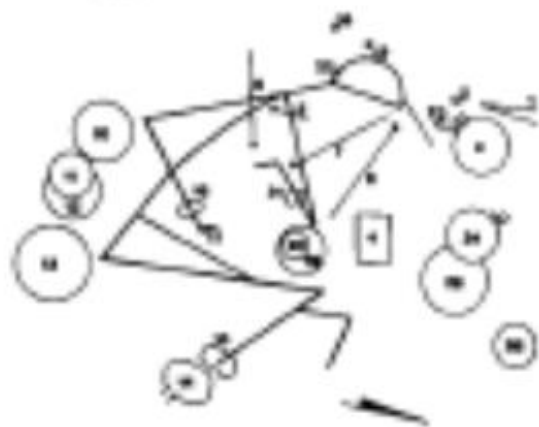

29 Period III tomb, detailed plans of Burials A and B.



Plate XIX: Period III tomb: Burial A *in situ*.

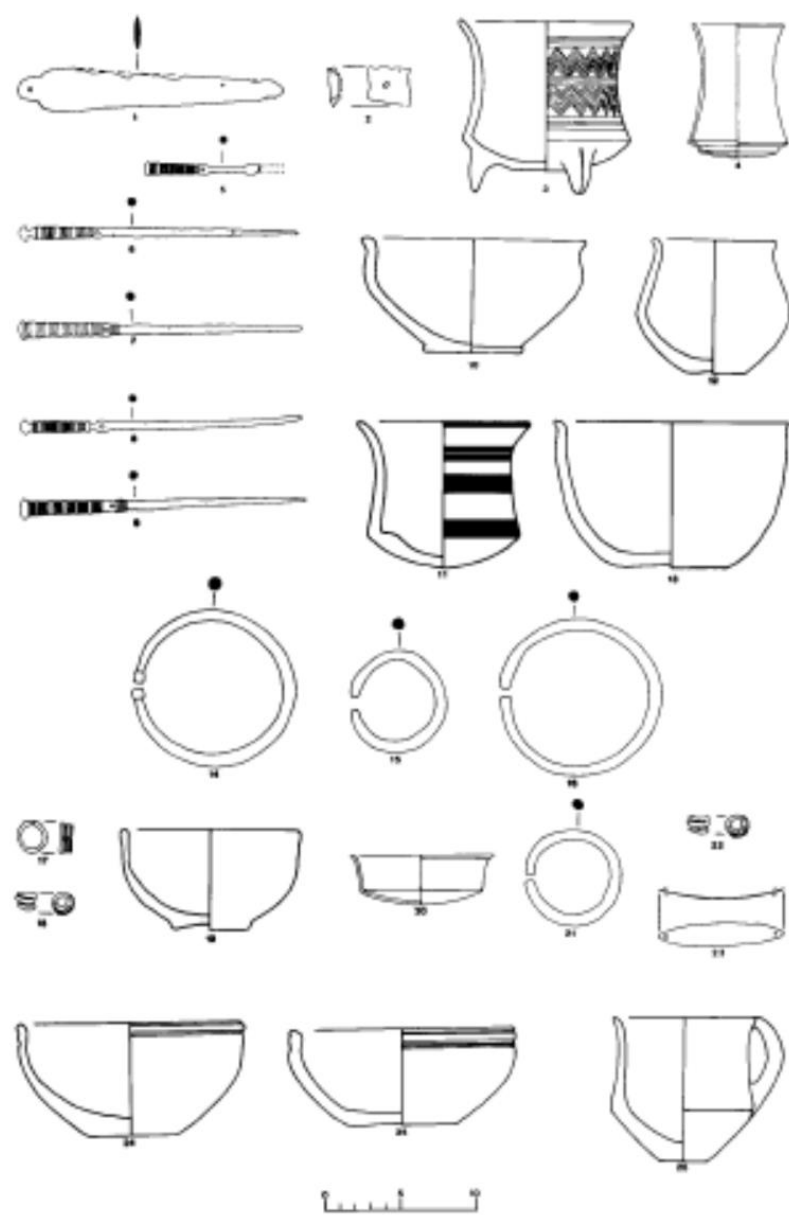

30 Period III tomb, Burial B grave goods.

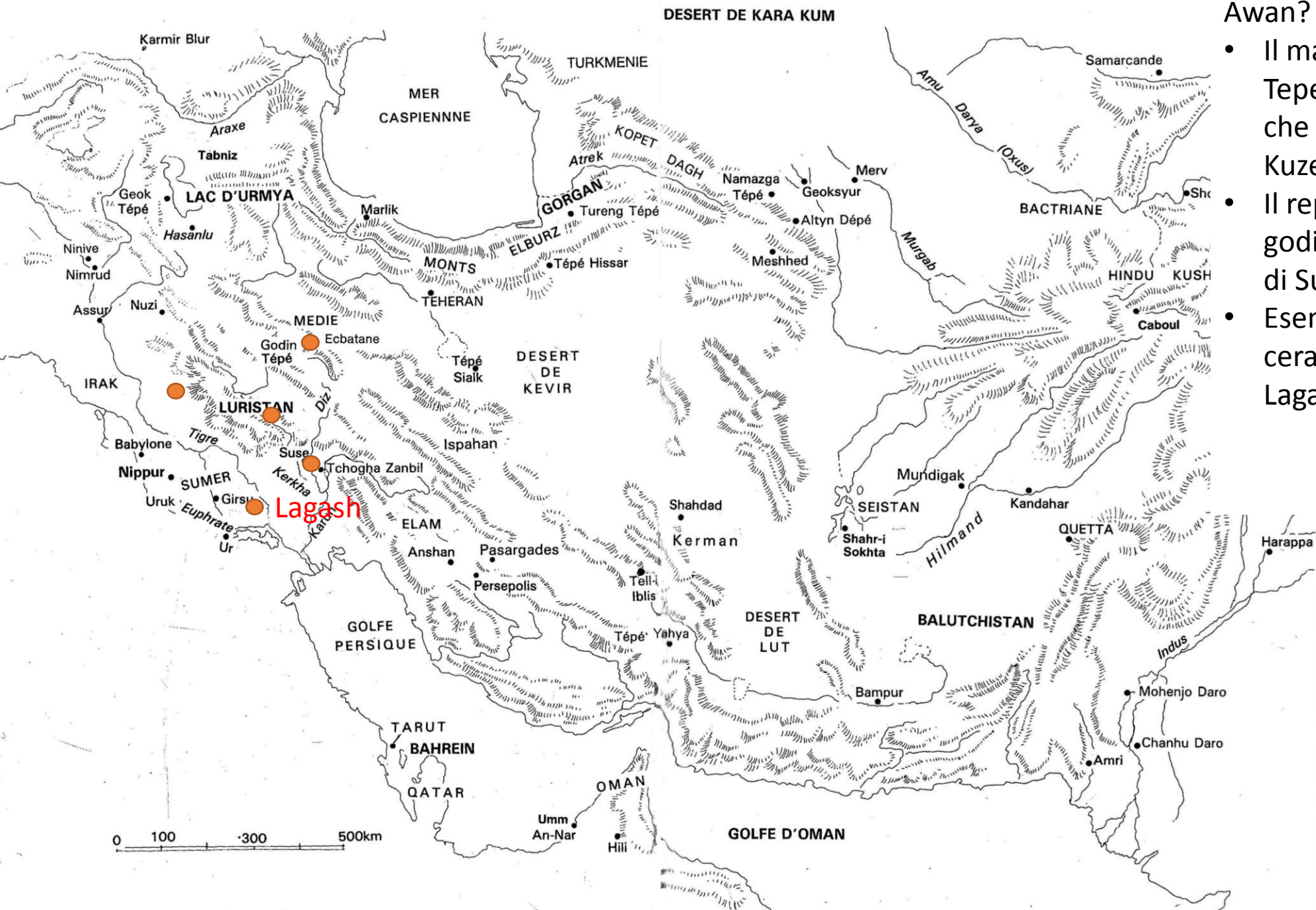

Awan?

- Il materiale trovato a Godin Tepe si ritrova in tutte la valli che collegano il Luristan con il Kuzestan
- Il repertorio ceramico dipinto di godin Tepe III è simile a quello di Susa IV
- Esempi di questo materiale ceramico sono ritrovati anche a Lagash