

# A selection of LCA case studies

## A.1 Regenerative Gas turbine with Cogeneration (CGAM example)

This example applies LCA, using ECO-Indicator\_95, to the reference case study of a regenerative gas turbine power plant cogeneration (CHP plant for Combined Heat and Power), described in the CGAM test case proposed by Tsatsaronis (1999). The plant produces 30 MW of electricity and a stream of superheated steam (14 kg/s at 20 bar, 485 K). The whole plant was re-simulated developing an EES (Engineering Equation Solver) code, in order to be able to calculate the missing data for mass flows etc. Check points demonstrated that the model is correctly reproducing the data reported test case.

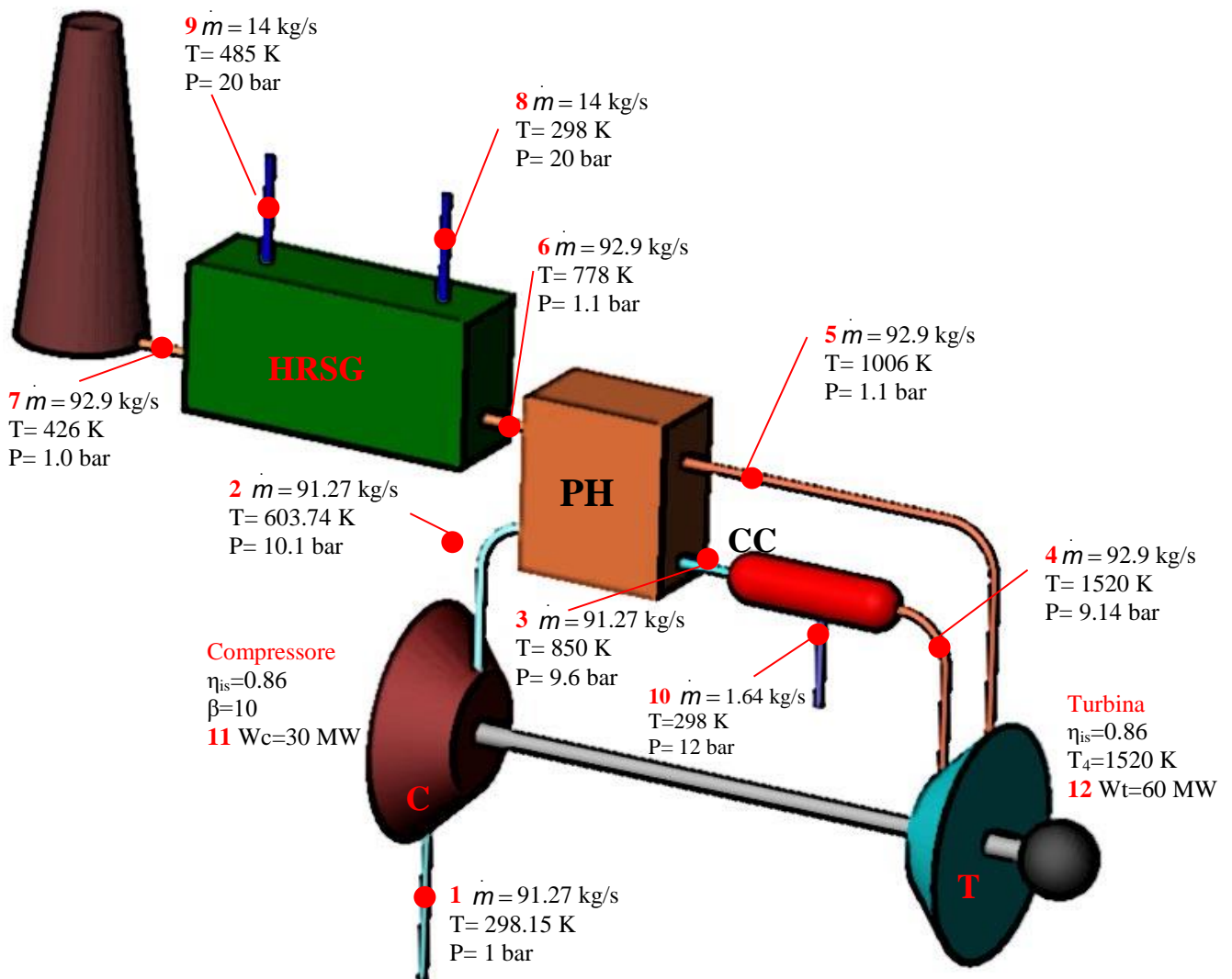

The LCA case study was divided in 3 phases: **construction, production, and dismantling**.

E' stato considerato il trasporto dei materiali da costruzione assumendo una distanza media percorsa pari a 500 Km. L'energia utilizzata nella realizzazione dell'impianto è stata calcolata seguendo la regola empirica del 6/10, proporzionalmente al peso totale dell'impianto (Coulson, Sinnott e Richardson 1983). Inoltre tale energia è stata assunta per l'85% proveniente da fonte Diesel mentre il restante 15% da rete elettrica (Emmerson, et al. 1995); questa ripartizione è usata anche in seguito per le fasi di esercizio e smantellamento.

La Tabella riporta i quantitativi totali dei materiali utilizzati nella fase di costruzione dell'impianto.

Denominazione	Utilizzo	Quantità	
Acciaio da costruzione	ghisa, acciaio da costruzione	354,5	ton
Acciai Leghe Speciali	TAG, piatti scambiatori..	370,1	ton
Rame	motore pompa + cavi elettrici	4,03	ton
PVC e Poliuteroano	isolante tubi e cavi	5,1	ton
Asfalto	copertura	750	ton
Cemento	calcestruzzo	3650	ton

Tabella : Materiali utilizzati in fase di costruzione

I dati raccolti sono stati implementati nel software **Simapro 7.1**, ed è stata utilizzata la metodologia Eco Indicator 99 per il calcolo dei valori degli indicatori relativi alle emissioni ed ai prodotti del sistema nelle fasi di costruzione, esercizio e smantellamento.

Per l'analisi condotta sono stati considerati significativi solo contributi all'*Eco Indicator 99* più alti dell' 1%.

Come **unità funzionale** di riferimento si è scelto il **kWh elettrico** prodotto dall'impianto.

Confrontando i contributi alle varie categorie di danno delle tre fasi si nota come la fase di esercizio sia preponderante rispetto sia alla fase di costruzione, ma soprattutto rispetto a quella di smantellamento. Per quanto riguarda quest'ultima, le percentuali in peso dei materiali riciclati vengono considerate un impatto mancato, quindi scalate dalle emissioni totali ed in tal caso si ottengono valori negativi di emissioni.

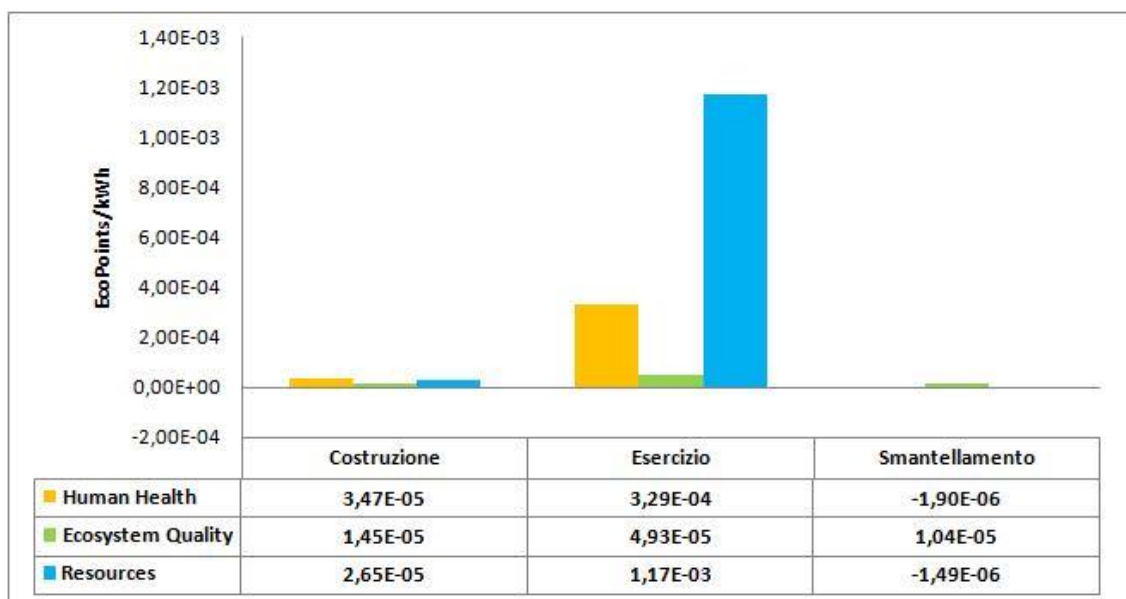

Confronto tra contributi alle categorie di danno per le fasi costruzione, esercizio, smantellamento

Il contributo maggiore è il danno alle risorse, dovuto al consumo di gas naturale nell'arco dei 15 anni di vita.

La tabella successiva riporta i contributi nelle tre fasi per quanto riguarda tutte le categorie di impatto; si nota come i valori maggiori per la fase di esercizio, in termini di **Ecopunti/kWh**, si riscontrino nelle categorie *Fossil Fuels*, *Climate Change* e *Resp. Inorganics*.

Categoria d'impatto	Unità	Costruzione	Esercizio	Smantellamento
<b>Totale</b>	Pt/kWh	7,58E-05	<b>1,55E-03</b>	6,96E-06
<b>Carcinogens</b>	Pt/kWh	3,48E-06	1,31E-05	-2,58E-07
<b>Resp. organics</b>	Pt/kWh	1,82E-08	2,50E-07	-1,94E-09
<b>Resp. inorganics</b>	Pt/kWh	2,75E-05	<b>1,97E-04</b>	-1,12E-06
<b>Climate change</b>	Pt/kWh	3,63E-06	<b>1,17E-04</b>	-5,25E-07
<b>Radiation</b>	Pt/kWh	2,11E-08	1,28E-07	4,33E-10
<b>Ozone layer</b>	Pt/kWh	1,03E-09	1,27E-06	-4,30E-10
<b>Ecotoxicity</b>	Pt/kWh	3,58E-06	4,82E-06	1,06E-05
<b>Acidification/ Eutrophication</b>	Pt/kWh	2,18E-06	3,13E-05	-1,06E-07
<b>Land use</b>	Pt/kWh	8,79E-06	1,32E-05	-1,69E-07
<b>Minerals</b>	Pt/kWh	6,55E-06	4,08E-06	-2,75E-07
<b>Fossil fuels</b>	Pt/kWh	2,00E-05	<b>1,17E-03</b>	-1,22E-06

Contributi alle varie categorie d'impatto per le fasi di costruzione, esercizio e smantellamento

Per la **fase di costruzione** si riportano i grafici relativi agli ecopunti complessivi, in quanto permettono di fare delle prime considerazioni sull'impatto del sistema non ancora in funzione, e che quindi non necessita ancora della scalatura rispetto al kWh prodotto che è l'unità funzionale scelta come riferimento.

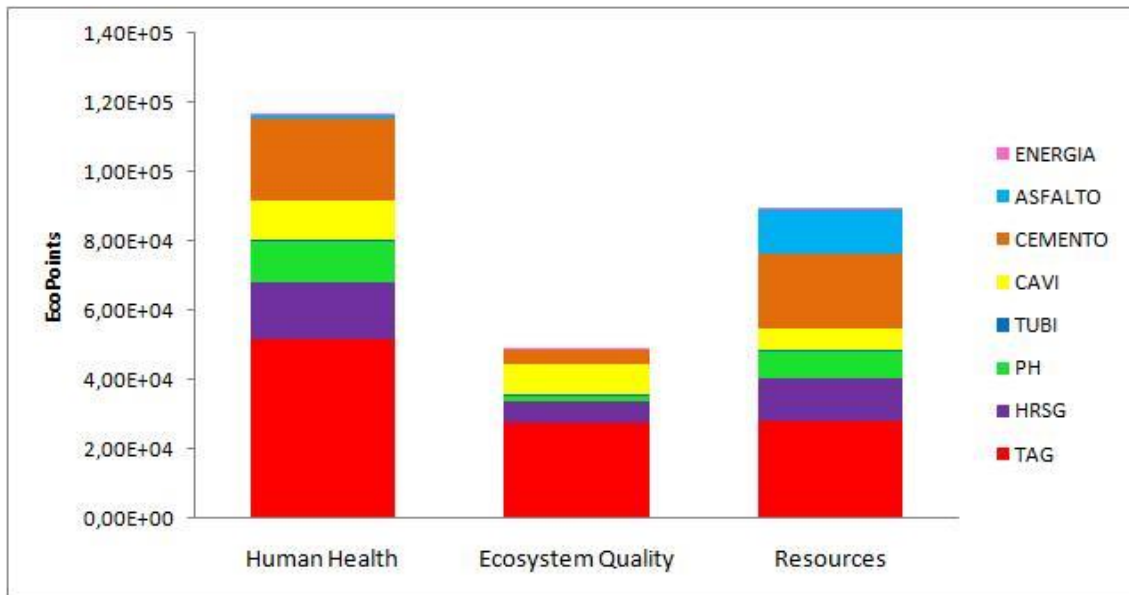

Valutazione della **fase di Costruzione** per categoria di danno

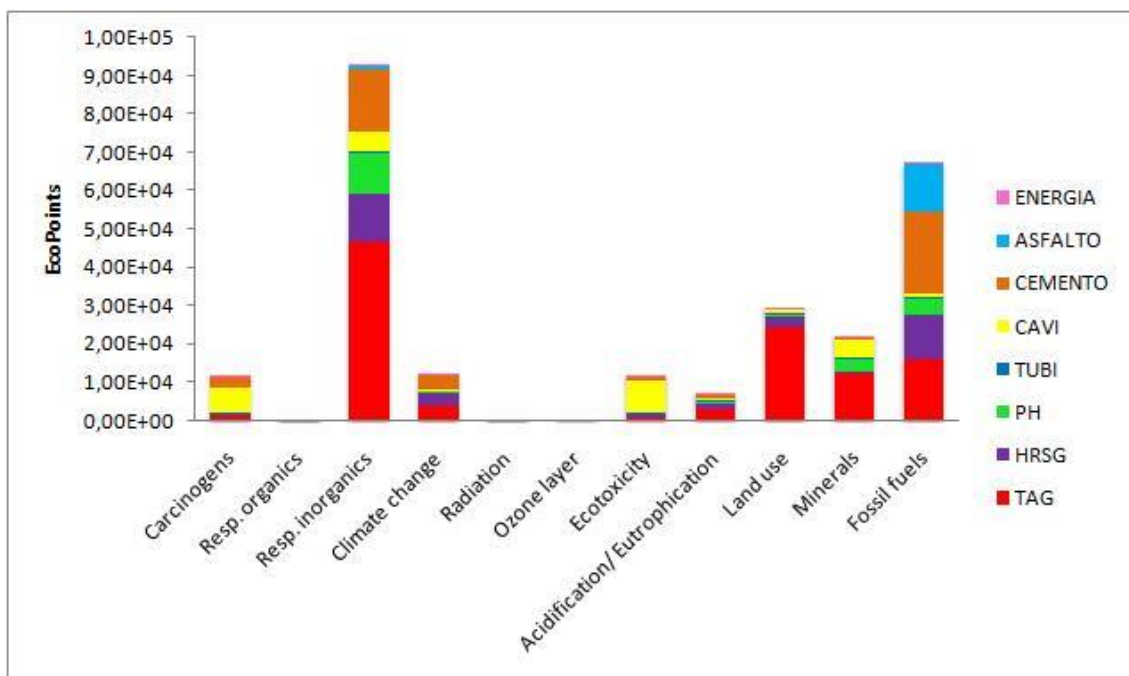

Valutazione della **fase di Costruzione** per categoria di impatto

## Phase 2 - Plant Operation

During the Plant Operation Phase the input is basically fuel, assumed as pure methane; and the materials needed for substitution of hot parts etc. during normal servicing of the plant; outputs are basically electricity and steam, and stack emissions.

A life time of 15 years was considered, with 7500 hours/year of operation. Combustion emissions were calculated by means of the *processes/material/fuels* SimaPro and Corinair data bases, including those linked to extraction and transportation of the fuel (2000 km). For large service intervention related to the gas turbine, a time period of 5 years was considered, with substitution of 20% of the original weight of the gas turbine.

The following table summarizes the emissions in the operation phase:

Substance	Emissions (g/GJ)	Emissions (kg)
NOx	300	3.9E6
N2O	0,5	19440
CO	80	1.0368E6
CO2	150	1950E6
UHC	4	5.1E6

Stacks Emissions in g/GJ e Kg during life time (15 years)

Each emission can contribute to different impact categories, that is, to the buildup of different indicators; the following table documents the relative weights used for building the category indicator from the data of the life-time emissions during plant operation:

Substance	GreenhouseEffect	Eutrophization	Acidification	Smog	Carcinogenics
NOx		0.13	0.7		
N2O	270				
CO2	1				
UHC				0.398	0.000011

Classification and weighting factors (SimaPro)

E' interessante andare a considerare specificatamente per la fase di esercizio la categoria **Climate Change**, formata quasi esclusivamente dalle emissioni di CO<sub>2</sub> :

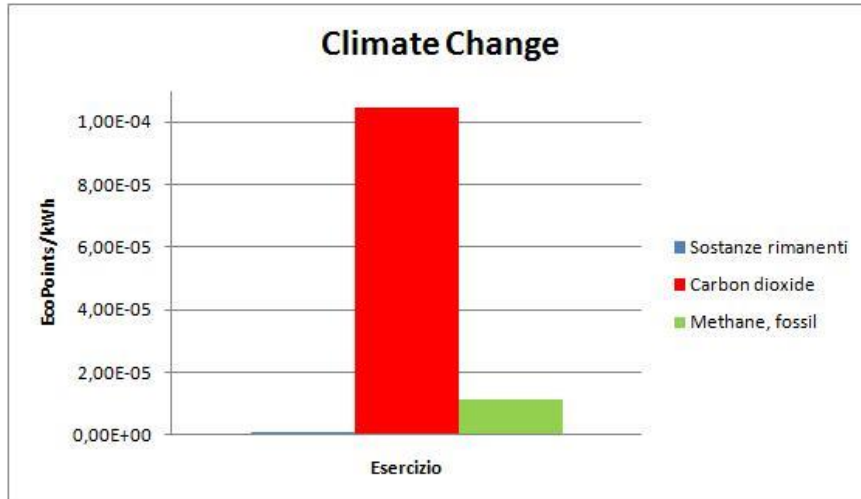

Contributo al **Climate Change** nella fase di **Esercizio** di impianto

Si riportano inoltre sempre per la fase di esercizio i grafici relativi alle emissioni e ai prodotti di sistema per quanto riguarda i contributi più interessanti di *Human Health*, *Ecosystem Quality* e *Resources*.

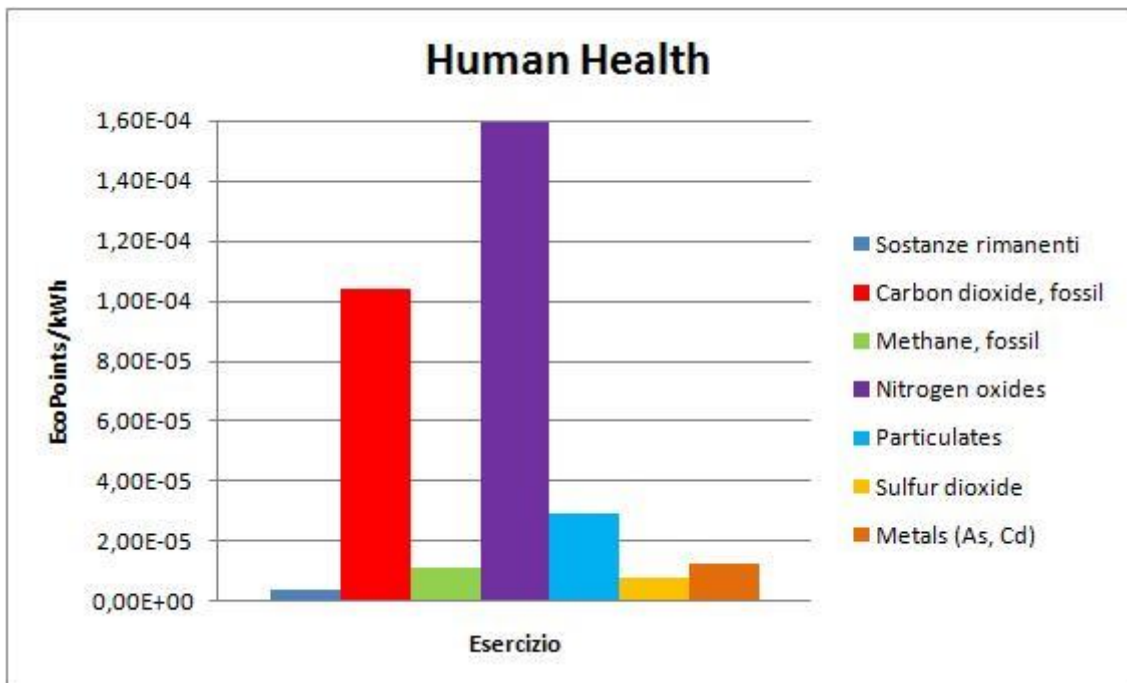

Emissioni (contributo **Human Health**) nella fase di **Esercizio**

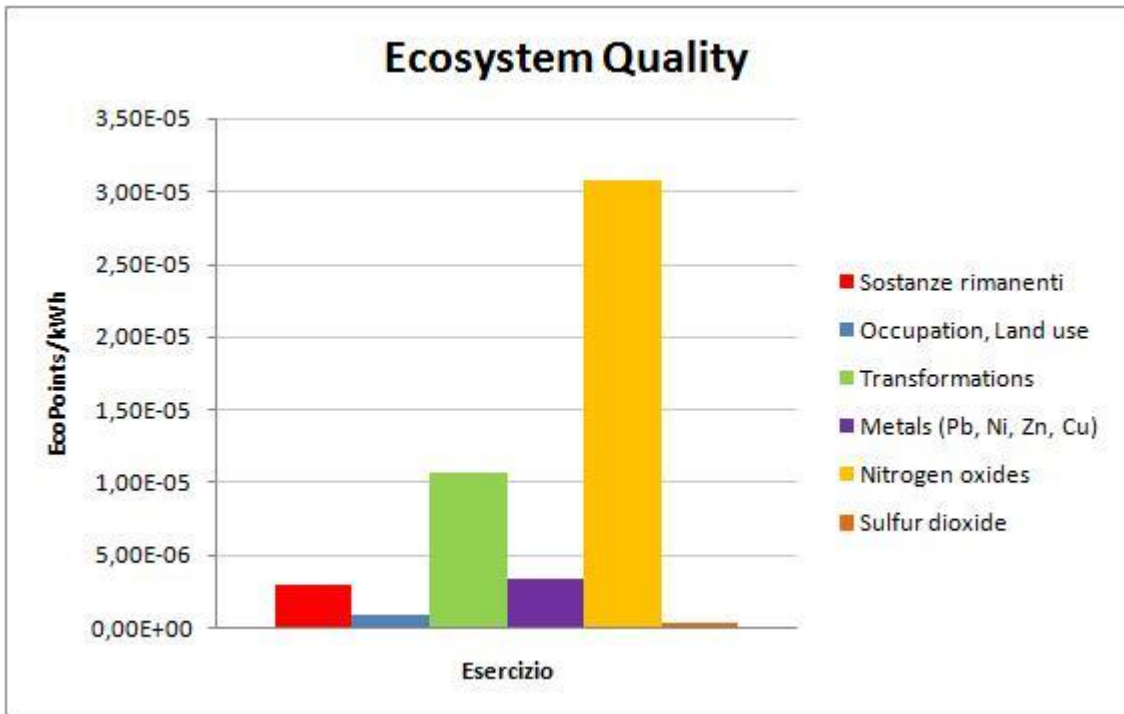

Contributo ad Ecosystem Quality in fase di Esercizio

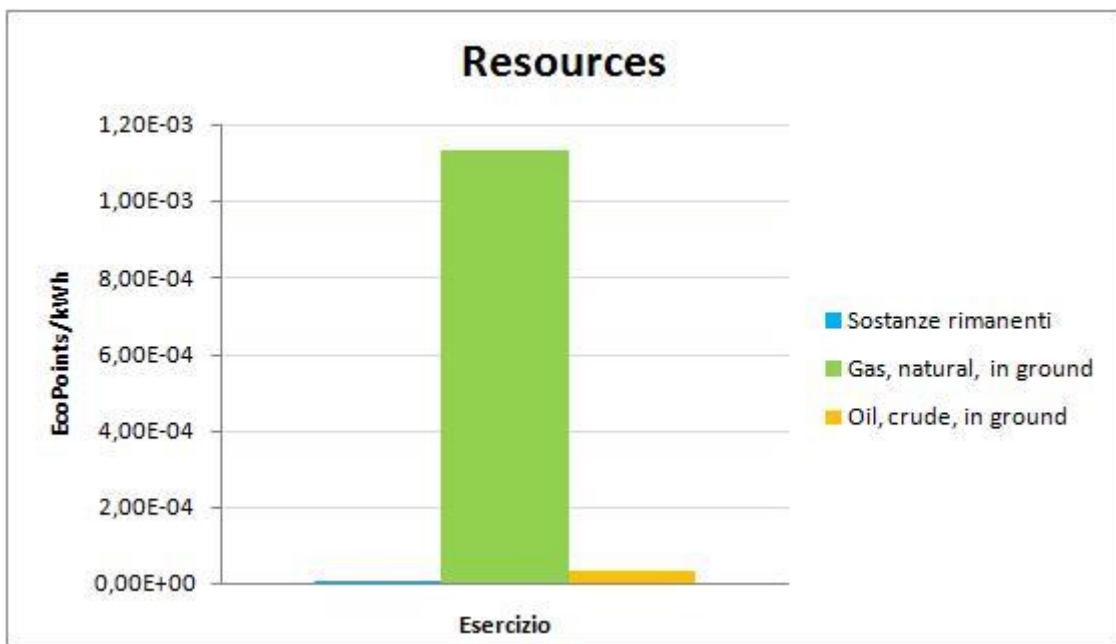

Contributo a Resources in fase di Esercizio

### Phase 3 - Decommissioning

The **Plant Decommissioning Phase** includes disassembly, transport over an average distance of 1000km and recycling or final disposal of all materials.

The main input is energy needed for dismantling and transport; output flows include airborne emissions and materials going to recycle or final disposal.

For energy, according to CIWEM practice, a mix of 85% direct diesel and 15% grid origin was considered. Dismantling involves cutting all elements so that they can be transported. Transport emissions were calculated according to the SimaPro *processes transportation database*. For material outputs, it is necessary to hypothesize a recycle/disposal scenario; this is hereby summarized:

Material	Disposal/Recycle
Steel	80% recovered, 20% landfill
Pig Iron	90% recovered, 10% landfill
Copper	100% recovered
Aluminium	100% recovered
Asphalt, Concrete	Crushed and recycled
PVC, plastics	To waste incinerator or landfill
Construction Steel in concrete	Landfill

SimaPro provides through its database set the impact of incineration or landfill disposal, once the weight of material is specified. **Recycling is treated as a minus sign emission**, that is, it is subtracted from the overall LCA value of the specific category. It is thus possible to achieve an overall negative value for a specific category indicator.

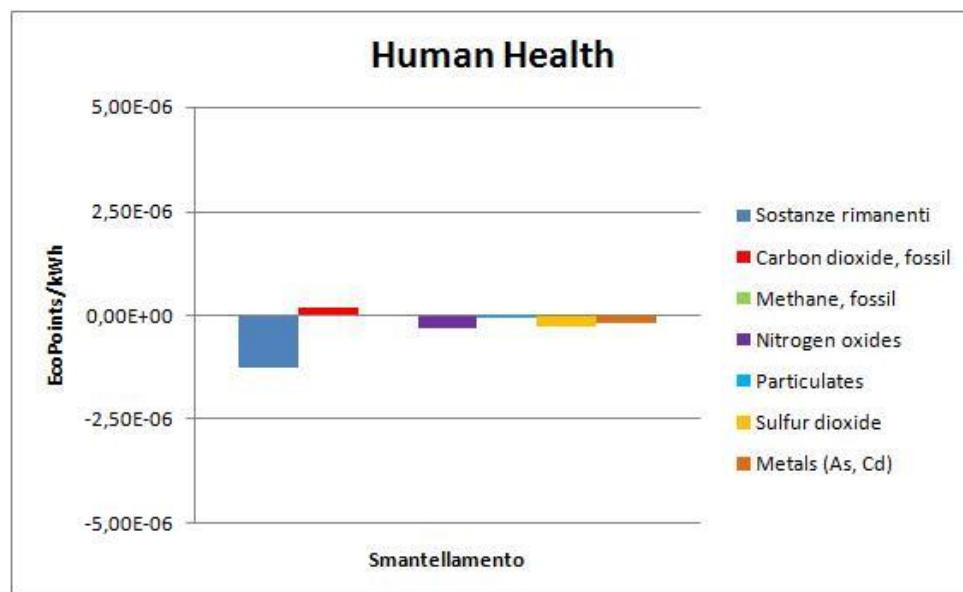

Emissioni (contributo **Human Health**) in fase di **Smantellamento**



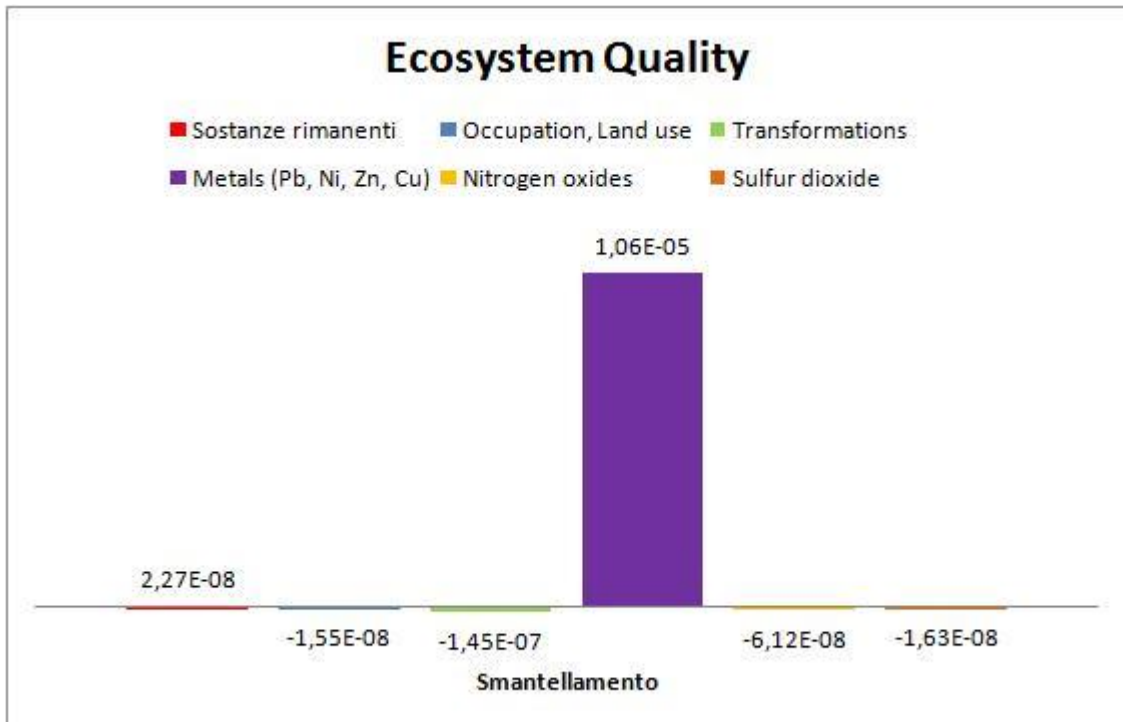

Contributo a **Ecosystem Quality** in fase di smantellamento

### Overall Evaluation

As happens for most power plants, the largest contribution to the buildup of the **ECO\_Indicator95** score comes from **Plant Operation**.

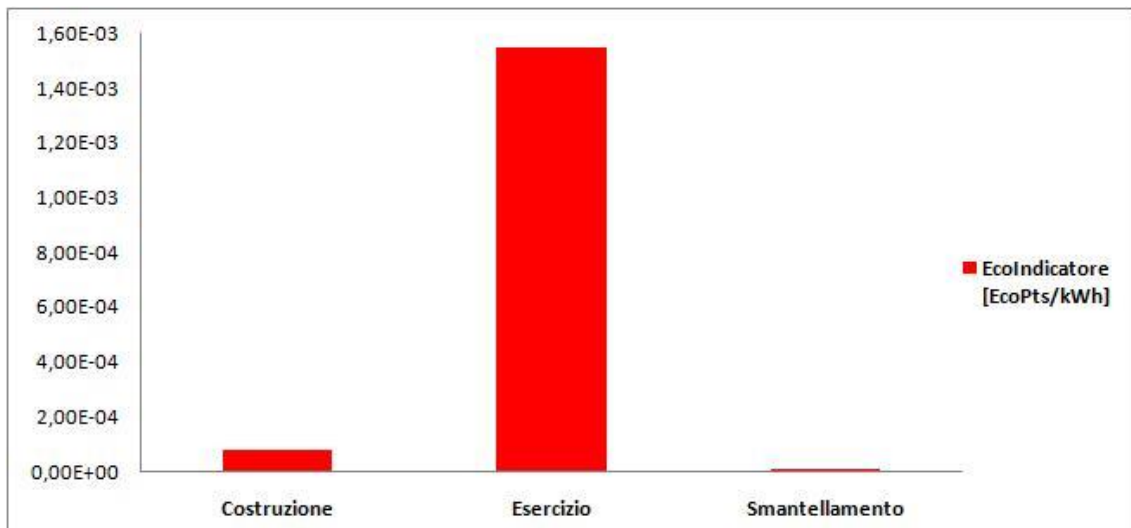

Ecoindicatore finale calcolato per kWh prodotto per le 3 fasi

**0,00161 EP/kWh = 1,61 EP/MWh (2004; 99% from fuel)**

Within the Operation Phase, and considering utilization of natural gas, a considerable part of the impact is coming from production and transport of the fuel.

It is possible to consider the allocation of the ECO\_Indicator95 overall score to the **different plant components**, and to the Energy consumption for Plant Construction. Turbine and Compressor, on account of the use of special metal alloys containing Mn, Ni, Co, display a heavy relative contribution to heavy metals; as all gaseous emissions are attributed to the Combustion Chamber, summer smog and greenhouse are relevant contributions to this component. The results are shown in the following figures:

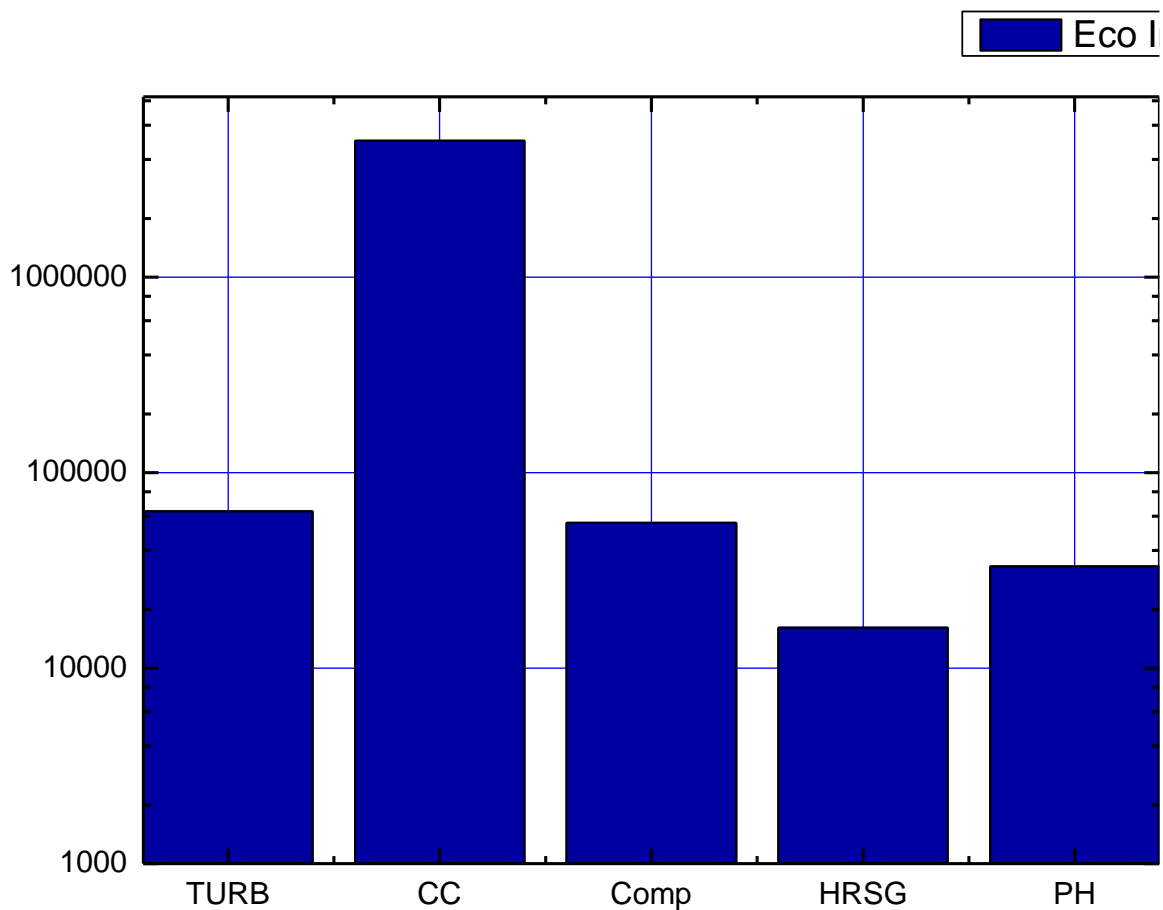

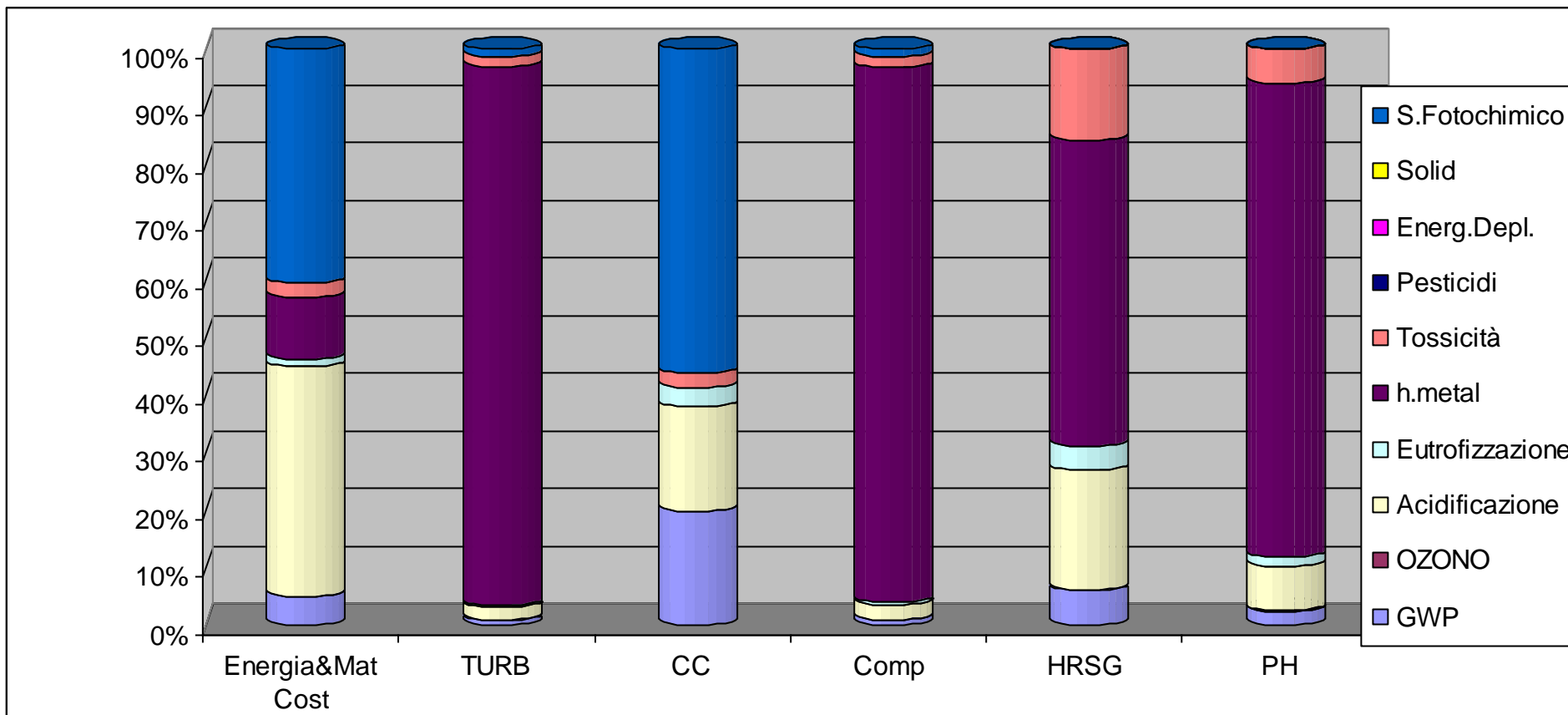

## A.2 LCA Analysis of a biomass cultivation and energy conversion process

The present case study refers to a **pilot biomass energy conversion** application. The location of the case study is in Italy, close to Pisa, where a gasification plant operating on wood coming from poplar short rotation forestry was proposed in the frame of a 4<sup>th</sup> EU framework program.

The cultivation scheme for poplar short rotation forestry is resumed in the following table:

**Timing of Poplar SRF**

Operation	Nursery			SRF								
	1	2	3	4	5	6	7	8	9	10	11	
plowing	1			1								
field dressing	1			1		1		1		1		
harrowing	1			1								
cuttings planting	1			1								
herbicides field distribution	1	1	1	1		1	1	1	1	1	1	1
surface dressing	1	1	1	1	1	1	1	1	1	1	1	1
herbicides local distribution	2	2	2	2	2	2	2	2	2	2	2	2
cultivating	4	4	4	4	2	4	2	4	2	4	2	2
antiparasitic agents application	2	2	2									
surface irrigation	2	2	2	2	2	2	2	2	2	2	2	2
nursery trees harvesting	1	1	1									
nursery trees transportation	1	1	1									
cuttings preparing	1	1	1									
biomass harvesting					1		1		1		1	
tree levelling			1									1

Poplar plants are nursed for three years, and then transplanted in open field; with an appropriate rotation of fields, harvesting is possible every 2 years. In the meantime several interventions are necessary, mainly for mechanical cultivation of soil, but also for chemicals (herbicides) and surface irrigation.

The case study considers an extensive cultivation, covering **28,5 km<sup>2</sup>**; for such large cultivation it was not considered viable to propose a biological cultivation scheme; so it was decided to use conventional chemicals (herbicides, insecticides, fungicides,...), even if to limited extents as can be guaranteed by carefully monitored cultivations.

The energy consumption and use of chemicals in cultivation are resumed in the following table:

### Energy consumption and use of chemicals in Poplar SRF cultivation

Operation	Machinery	Engine Power [kW]	Substance	Quantity [kg/ha]	Execution time [hr/ha]	
					Nursery	SRF
plowing	gangplow	80			1.85	1.85
harrowing	vertical spike-tooth harrow	80			0.69	0.69
cuttings planting	transplanter	51			11.43	11.43
field dressing	centrifugal dressing spreader	51	8-24-24	500	0.45	0.45
surface dressing	centrifugal dressing spreader	51	UREA	218	0.41	0.41
herbicides pre-emergency	dusting	51	METOLACLOR	1.7	0.26	0.26
			LINURON	0.5		
			PENDIMETALIN	0.8		
herbicides post-emergency	dusting	51	PIRIDATE	1.125	1.19	1.19
			FLAZIFOP-P-BUTYL	0.665		
			WATER-BASED	1		
cultivating	disk harrow	51			0.78	0.78
antiparasitic agents application	dusting	51	CHLORPYRIFOS	0.120	1.36	1.36
			CYPERMETHRIN	0.012		
			FENITROTHION	0.285		
surface irrigation	close-coupled pump	75+51	WATER	350000	3.12	3.12
nursery trees harvesting	cutter, logging shears	51 (228)			2.65	1.23
nursery trees transportation	grabbing crane	80			26.29	
cuttings preparing	electric powered saw	1.5			26.5	
tree levelling	horizontal spike-tooth harrow	80			4.84	4.84

### Toxicity table for chemicals

Active substance	Class	Type	oral LD50 [mg/kg]	dermal LD50 [mg/kg]
Metolaclo	III	Herbicides	2780	3170
Linuron	II-III	"	1500	5000
Pendimetalin	III	"	3000	5000
Piridate	III	"	2400	3400
Fluazifop-p-butyl	III	"	3300	2400
Chlorpyrifos	II	Insecticide	80	200
Cypermethrin	II	"	900	4800
Fenitrothion	II	"	200	1000
Glufosinate a.	III	Herbicide	1620	4000

The biomass yield and the energy content of biomass are resumed in the following table:

**Biomass yield and the energy content of biomass**

Biomass yield [Mg/ha/year]	LHV [MJ/kg]	HHV [MJ/kg]	Humidity [%]	After drying humidity [%]
20	17.7	19	60	15-20

A **fate analysis** was performed for the use of chemicals: the aim is determining how much of the chemicals is going to the soil, how much in air as emissions, and how much in plants:

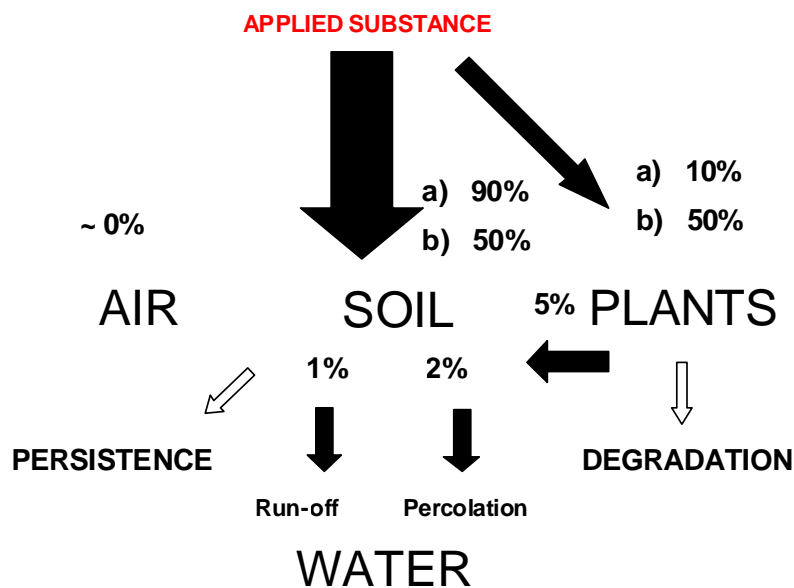

**Hypotheses for biomass transport**

Transport of biomass used Diesel trucks with a payload of 40 tons; the average distance was taken at 75 km on secondary roads.

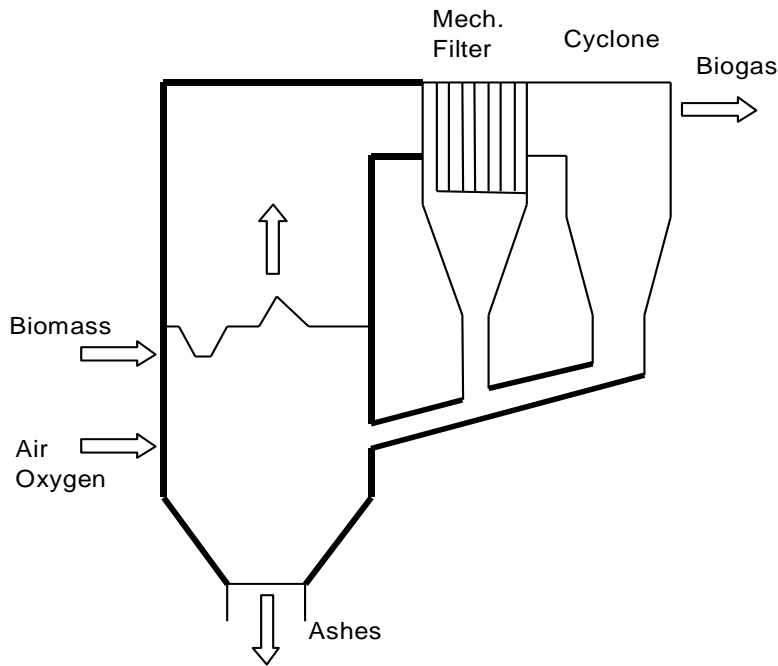

### Biomass Gassifier

A pressurized fluidized bed gassifier converted biomass into a syngas suitable for gas turbine applications.

Two conditions for gassifier operation were considered:

- a) Air-Blown Gassifier, producing a low-calorific value syngas
- b) Oxygen-Blown Gassifier, producing a medium-calorific value syngas

### Summary of Reference cases for Gassifier Operation

Code	Biomass humidity [%]	Oxidising agent	T [K]	p [bar]
15 AIR	15	Air	1050	15
20 AIR	20	Air	1050	15
15 O2	15	Oxygen	1050	15
20 O2	20	Oxygen	1050	15

The syngas composition was calculated using chemical equilibrium calculations for the different reference conditions. This had proved to be a correct approach for fluidized-bed gassifiers.

Condition	CO <sub>2</sub>	H <sub>2</sub> O	CO	CH <sub>4</sub>	C(s)	N <sub>2</sub>	H <sub>2</sub>	LHV
15 AIR	0.2279	0.08821	0.14699	0.00534	0.0144	0.50522	0.01194	3482
15 O2	0.45655	0.16703	0.28668	0.028	0.02734	0.01238	0.02202	7610
20 AIR	0.23506	0.10041	0.13983	0.00508	0.01263	0.49445	0.01254	3376
20 O2	0.46006	0.18831	0.26753	0.02571	0.02363	0.01177	0.02299	7225

kJ/kg

## Schematic of Gassifier/Combined Cycle layout

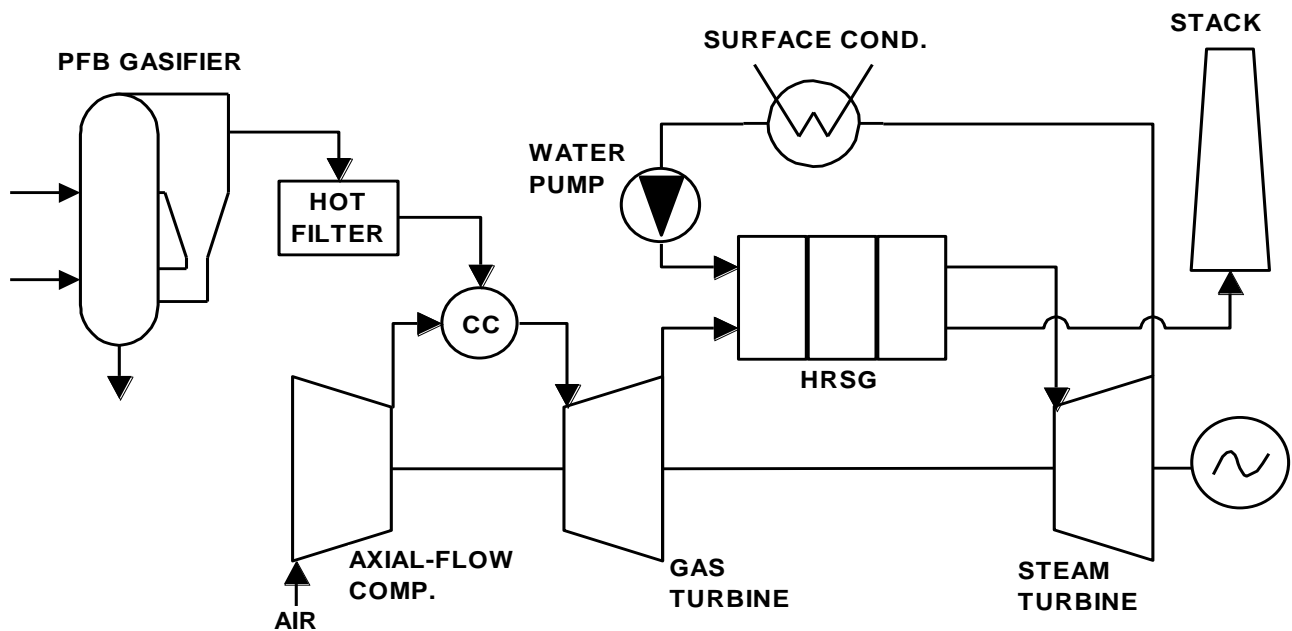

The plant layout considers very limited integration between gassifier and gas turbine/combined cycle. This appears a reasonable choice because of:

- the limited plant size (10 MWe Gas Turbine) , which did not allow to consider a two-pressure level HRSG
- the wet conditions of biomass, which suggest that no steam should be needed to promote the water-gas shift reactions.

### Gassifier/Combined Cycle Operating Parameters

Biogas gasifier output pressure [bar]	15
Biogas gasifier output temperature [°C]	800
Biogas filter output pressure [bar]	13.5
Biogas filter output temperature [°C]	700
Gas turbine pressure ratio	12
Biogas overpressure [%]	10
Gas turbine high temperature [°C]	1077
Steam superheater output pressure [bar]	70
Steam superheater output temperature [°C]	532
Superheater approach T [°C]	30
Steam turbine output pressure [bar]	0.1
Exhaust gas output pressure [bar]	1.01



### LCA Results – Biomass cultivation

**CO<sub>2</sub> emissions** for biomass cultivation amount to an estimate of **7330 kg/ha/year**. Other significant emissions are represented in the following figures in the same measurement units.

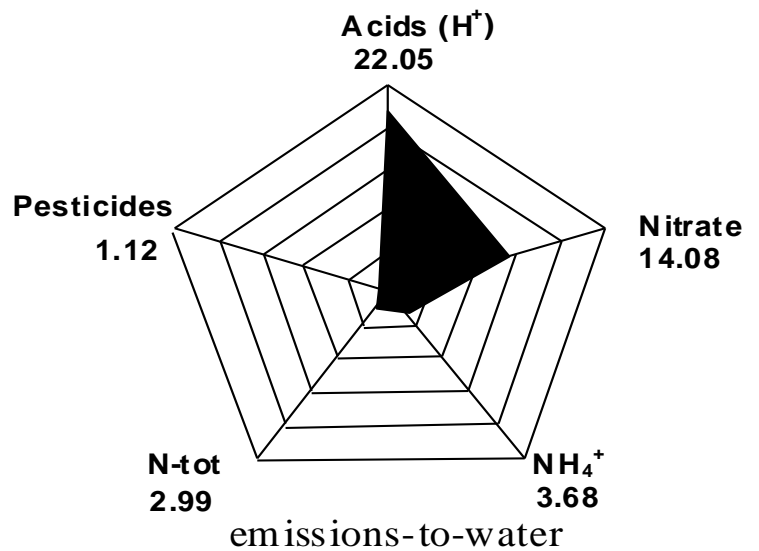
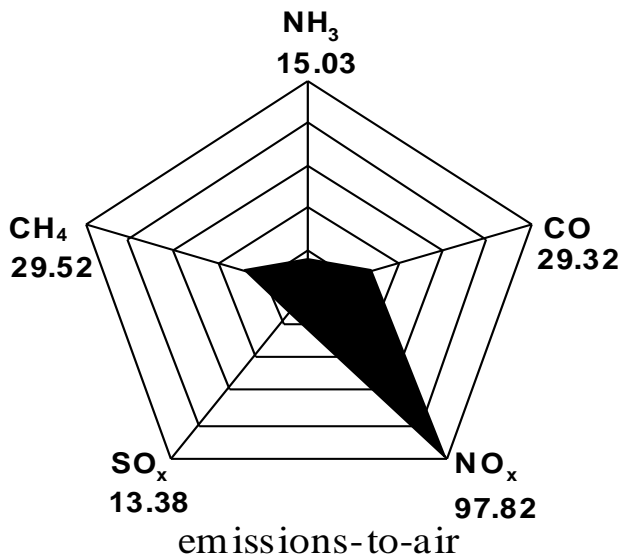

#### Emissions to Air:

CO and NO<sub>x</sub> are due to the stacks of Diesel engines used for soil cultivation. Methane and Ammonia emissions are traceable to the use of nitrogen compounds as fertilizers.

#### Emissions to Water:

Water pollution is coming from dispersion of acid and nitrate compounds. The sewage is limited but the damage to the water environment is large.

This figure collects the results after characterization and normalization. The large value for Europhization is due to nitrate compounds in fertilizers.

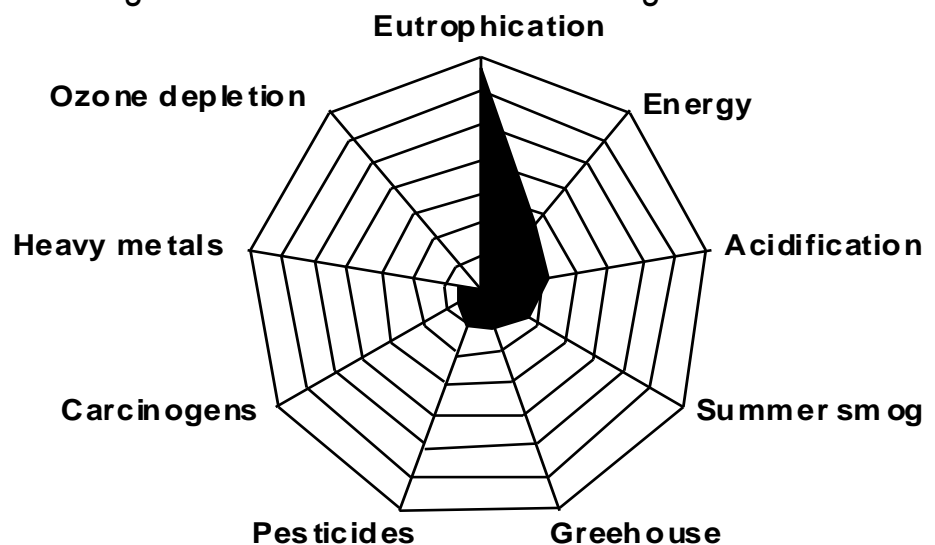

## LCA Results – Energy conversion of biomass

### Different Gassifier operating conditions:

Gassification with Oxygen determines a better energy efficiency of the process: the electricity production is larger for the same amount of biomass. However, energy for Oxygen production is taken from the electric grid: this means that the national primary fuel mix for electricity production should be considered for this electricity consumption (50% coal; 50% oil in the present case). This determines a larger environmental impact for Oxygen-blown gasification.

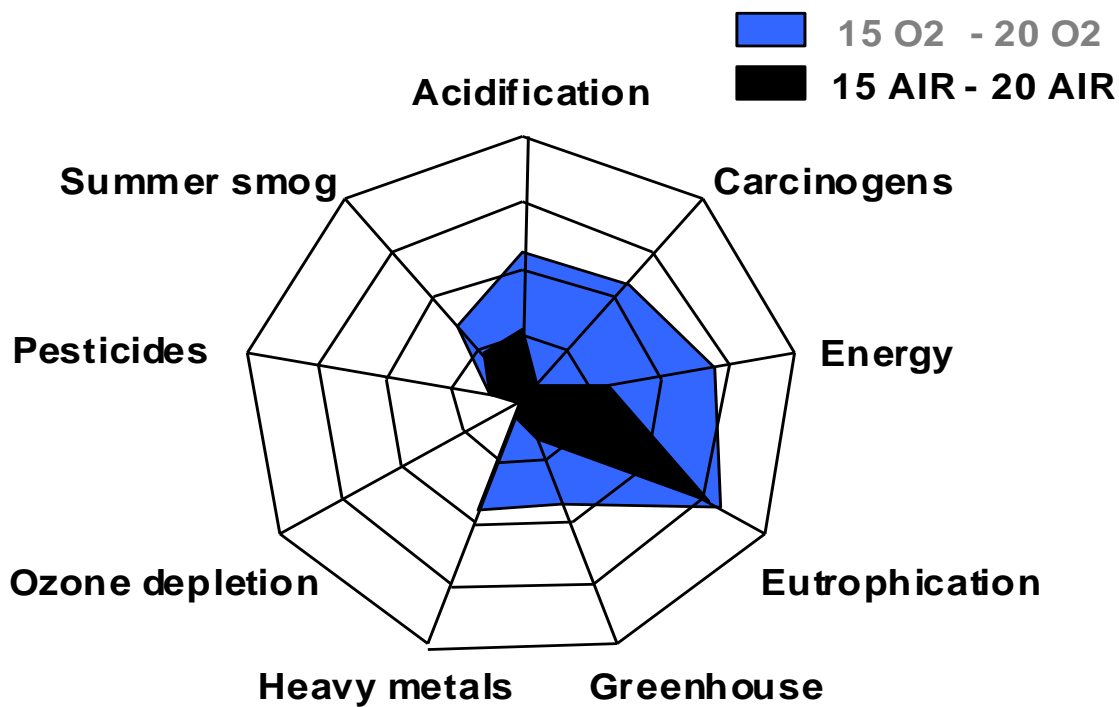

A significant share of renewables for the national electricity production scenario would change significantly these results. On the other hand, for a small-size power plant it is not reasonable to consider on-site production of Oxygen using a local Air Splitting Unit (ASU). This means that electricity for oxygen production cannot be taken from the gross power plant power output.

Finally, it was decided to consider an Oxygen-blown gassifier, because this simplified the utilization of the gas turbine with a medium-calorific value fuel.

**Comparison between use of Biomass and conventional fuels in the case-study.**

For the conventional fuel conversion, an average efficiency of 0,41 was considered, using the reference mix of primary sources (50% coal; 50% oil). The following figures demonstrate the much larger environmental compatibility of biomass utilization. A net advantage is evident for emission-to Air, while Emissions-to-Water are penalized by the use of Nitrate compounds as fertilizers.

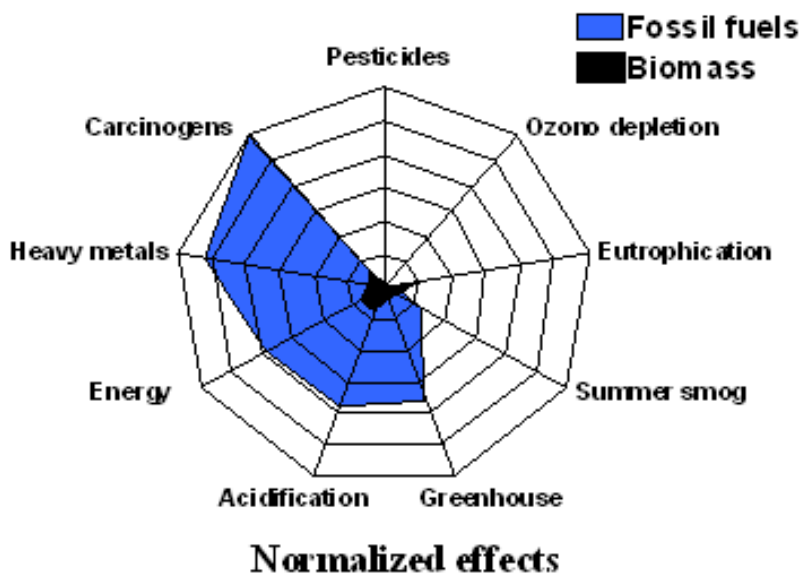
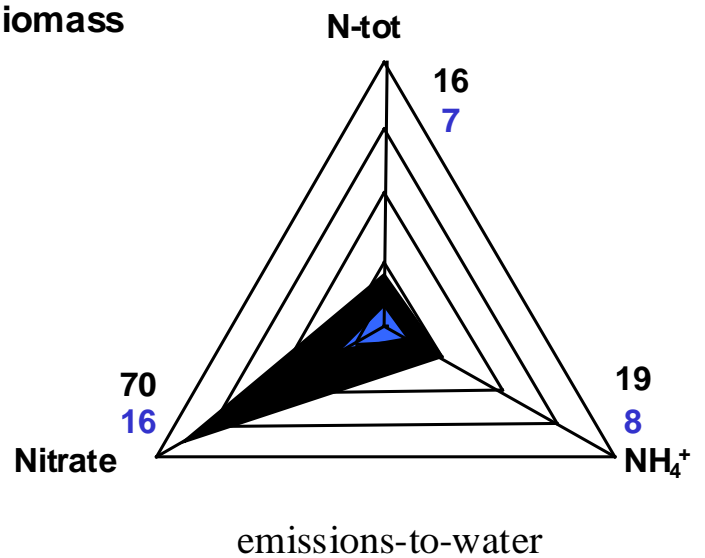
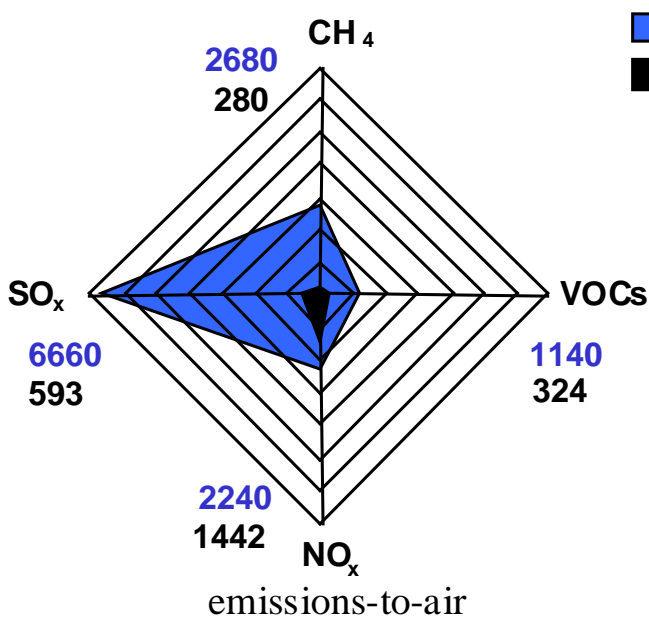

Normalization of effects confirms the convenience of biomass utilization.

In the evaluation of the Greenhouse effect, biomass was considered with a zero balance: only emissions of diesel engines for soil cultivation were accounted.

**ECO\_Indicator95 Score (EcoPoints per MWh)**

Building the ECO-Indicator95 for the biomass cultivation/energy conversion process (with Oxygen-blown gassifier), and for the conventional production of the same amount of electricity, one gets the quantitative result that biomass utilization is at least 5 times more environmental friendly.

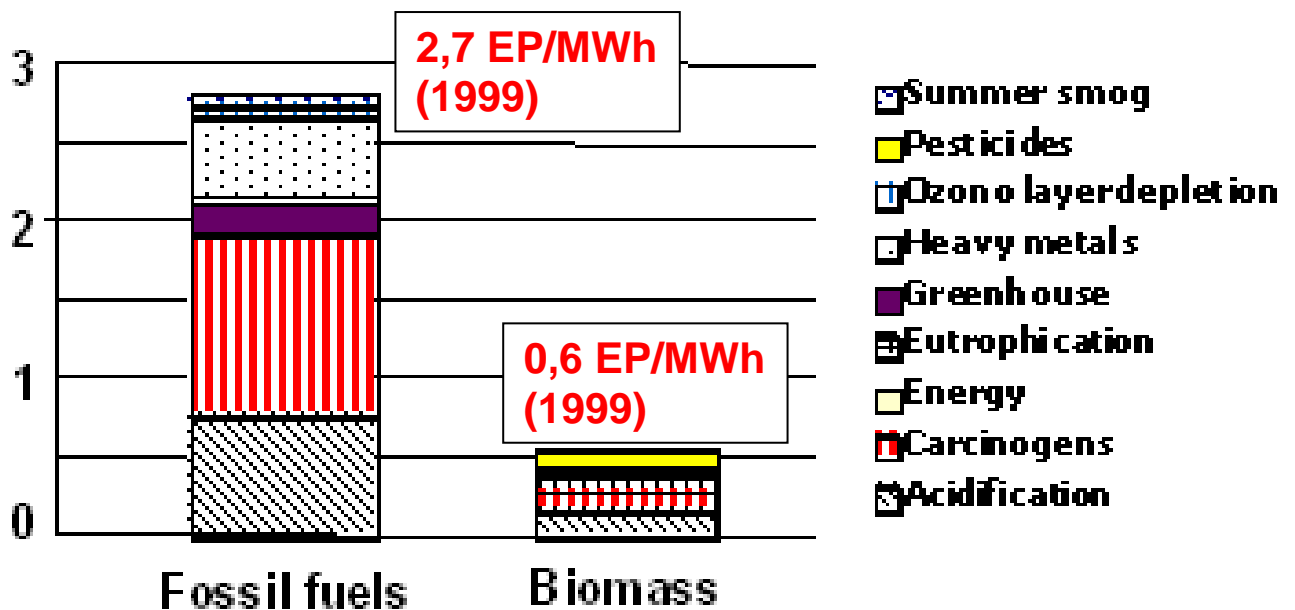

**Eco-indicators**

Referring to the main issue of Greenhouse Effect, biomass utilization in the cultivation/utilization life cycle involves an emission factor of about **110 kgCO<sub>2</sub>/MWh**; this should be compared with the **930 kgCO<sub>2</sub>/MWh** for the fossil fuel energy conversion with 0,41 efficiency (50% oil, 50% coal); The reduction factor is about 8,5.

**Efficiency Evaluation**

Production of **1 MWh (functional unit)** in the gassifier/combined cycle plant needs about **633 kg of biomass** (Lower heating value 17,7 MJ/kg). The resulting efficiency is:

$$\eta = \frac{3600}{17.7 \cdot 633} = 0.321 \quad \frac{3600 \text{ MJ/MWh}}{17,7 \text{ MJ/kg} * 633 \text{ kg/MWh}}$$

It is more correct to consider energy spent for cultivation, determining a **Life-Cycle Efficiency** including biomass cultivation and energy conversion:

$$\eta_{LC} = \frac{E_g - E_u}{E_b} \quad \eta_{LC} = \frac{3600 - 2256.8}{17.7 \cdot 633} = 0.119$$

where:

$E_g$  = electric energy produced during the whole life cycle

$E_u$  = energy needed for **cultivation and transport of biomass** before of the energy conversion plant; this amounts to **2256,8 MJ**, referred to the biomass (**633 kg**) **needed to produce 1 MWh of electricity**.

$E_b$  = energy content of biomass cumulated over the whole life cycle

Even if  $\eta_{LC} = 0,119$  can look as a small value, one should consider that even negative values would result for fossil fuels (Energy needed for extraction and transport is larger than the electricity produced).

### Final evaluation for LCA of short-rotation forestry biomass

With reference to cultivation, the larger impact is due to the **use of chemicals and fertilizers**. Improvements could be obtained with a better tuning of the biomass/fertilizer ratio, and using biologic anti-parasitic methods rather than chemicals.

The **use of bio-diesel for cultivation** could reduce sensibly the CO<sub>2</sub> emissions.

With reference to the energy conversion phase (gassifier and combined cycle), the use of air instead of Oxygen would reduce the environmental impact by a factor 2 to 7. However, this is not considered as a viable option in the near and mid term, because it would involve the complete redesign of the gas turbine.

### A.3 LCA of Hydrogen production via Natural Gas Steam Reforming

#### A.3.1 Presentation of the Case Study

This example summarizes the results of a LCA study of Hydrogen production via **Natural Gas Steam Reforming**, performed at the U.S.A. National Renewable Energy Laboratory (NREL) by Spath and Mann in 2001.

Steam reforming is the state-of-the-art process for large-scale hydrogen production. The process considered in this case study is described in the following figure:

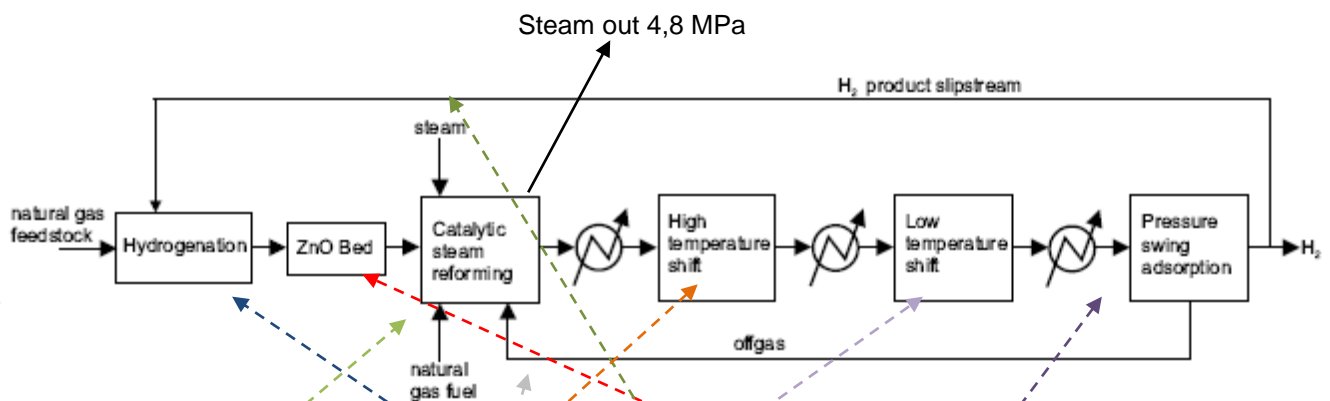

Natural gas is first treated in an **Hydrogenation reactor**, converting all Sulphur in H<sub>2</sub>S, using a small quantity of H<sub>2</sub> – acting as reducing agent – taken from the final output stream. H<sub>2</sub>S is then removed passing through **metal oxide (ZnO) bed**. The **steam reformer** is working with **2,6 MPa (medium-pressure) steam**. After cooling the gas enters a **High Temperature Shift reactor**; a second cooling Stage takes the product stream at the **Low Temperature Shift reactor**, which is needed to achieve a high (92%) conversion of CO into H<sub>2</sub>. The final stage is a **Pressure Swing Adsorption unit** used for gas purification. The PSA off-gas (in volume: 55% CO<sub>2</sub>; 27% H<sub>2</sub>; 14% CH<sub>4</sub>; 0,4%N<sub>2</sub> + H<sub>2</sub>O and minor components) is recycled as fuel for the Reformer, which uses also a fuel stream natural gas (about 4,4% of the total mass flow of NG). **The steam reformer is producing high-pressure steam (4,8 MPa), which is supposed to be used by external users.** Pumps and compressors take electricity from the grid. The main plant operation parameters are summarized in the following table:

Table 1: Steam Methane Reforming Hydrogen Plant Data

Design Parameter	Data	
Plant size (hydrogen production capacity)	1.5 million Nm <sup>3</sup> /day (57 million scfd)	1,5 MNm <sup>3</sup> /day H <sub>2</sub>
Hydrogen purity	Industrial grade (>99.95 mol% H <sub>2</sub> )	
Average operating capacity factor	90%	
Natural gas consumed @ 100% operating capacity	392 Mg/day (feed) 43 Mg/day (fuel)	392+43 Ton/day NG
Steam requirement (2.6 MPa or 380 psi) @ 100% operating capacity	1,293 Mg/day	
Steam production (4.8 MPa or 700 psi) @ 100% operating capacity	1,858 Mg/day	
Electricity requirement @ 100% operating capacity	153,311 MJ/day	
Hydrogen plant energy efficiency (higher heating value (HHV) basis)	89% (defined in text below)	

Note: The hydrogen plant efficiency changes if the excess steam can not be utilized by a nearby source. However, this does not change the amount of hydrogen produced by the plant.

The **Hydrogen Plant Energy Efficiency** is calculated as the ratio:

$$\frac{\text{energy in product hydrogen} + 4.8 \text{ MPa steam energy (exported)}}{\text{natural gas energy} + \text{electricity} + 2.6 \text{ MPa steam energy (required)}}$$

The **System Boundaries** considered for the LCA study include the plant and production and transport of natural gas. Avoided emissions should be considered in the LCA, notably those which would be encountered for production of the 4,8 MPa steam. A Life Cycle Assessment software (TEAM) was used for this study. The primary energy use for production of electricity is taken from the reference mid-continental U.S.A. scenario (64,7% Coal; 5,1% Lignite; 18,4% nuclear; 10,3% hydro; 1,4% natural gas; 0,1% oil; power distribution losses 7,03%).

The **Inventory Analysis** gave the following results for raw materials needed for plant construction:

Table 2: Hydrogen Plant Material Requirements (Base Case)

Material	Amount required (Mg)
Concrete	10,242
Steel	3,272
Aluminum	27
Iron	40

The large size of the plant – 1.5 MNm<sup>3</sup>/day, which is considered as the normal unit for future commercial operation for large-scale hydrogen production – requires an **increase in the pipelines distributing natural gas**, which was estimated in additional 12539 Mg of steel. The distribution of natural gas involves losses of the gas to the environment (compressor leakages, pneumatic control devices) which were estimated at a value of **1,4%** of the total flow.

The Life Cycle Inventory allowed to calculate the **Air Emissions** during the Life Cycle (20 years + 2 years for construction), which are resumed in the following table, referred to the **Functional Unit (1 kg of H<sub>2</sub>)**:

Table 4: Average Air Emissions

Air Emission	System total (g/kg of H <sub>2</sub> )	% of total in this table	% of total excluding CO <sub>2</sub>	% of total from construction & decommissioning	% of total from natural gas production & transport	% of total from electricity generation	% of total from H <sub>2</sub> plant operation	% of total from avoided operations
Benzene (C <sub>6</sub> H <sub>6</sub> )	1.4	< 0.0%	1.3%	0.0%	110.9%	0.0%	0.0%	-10.9%
Carbon Dioxide (CO <sub>2</sub> )	10,620.6	99.0%		0.4%	14.8%	2.5%	83.7%	-1.5%
Carbon monoxide (CO)	5.7	0.1%	5.3%	2.0%	106.3%	0.7%	1.4%	-10.4%
Methane (CH <sub>4</sub> )	59.8	0.6%	55.7%	< 0.0%	110.8%	< 0.0%	0.0%	-10.9%
Nitrogen oxides (NO <sub>x</sub> as NO <sub>2</sub> )	12.3	0.1%	11.0%	1.8%	90.3%	9.5%	7.3%	-8.9%
Nitrous oxide (N <sub>2</sub> O)	0.04	< 0.0%	< 0.0%	7.3%	37.6%	58.7%	0.0%	-3.7%
Non-methane hydrocarbons (NMHCs)	16.8	0.2%	15.6%	1.7%	89.8%	14.5%	0.0%	-6.0%
Particulates	2.0	< 0.0%	1.8%	64.5%	25.2%	11.6%	1.1%	-2.5%
Sulfur oxides (SO <sub>x</sub> as SO <sub>2</sub> )	9.5	0.1%	8.8%	13.5%	68.3%	24.9%	0.0%	-6.7%

Note: Construction and decommissioning include plant construction and decommissioning as well as construction of the natural gas pipeline.



**CO<sub>2</sub>** represents the largest emission, scoring 99% of the total. **Methane** is the next greatest quantity, followed by minor emissions. Apart of CO<sub>2</sub>, all emissions result from the natural gas production and transport process. The large amount of greenhouse emissions (CO<sub>2</sub> and CH<sub>4</sub>) calls for a detailed analysis in terms of **Global Warming Potential**. The results after normalization are resumed in the following table:

**Table 5: Greenhouse Gases Emissions and Global Warming Potential**

	Emission amount (g/kg of H <sub>2</sub> )	Percent of greenhouse gases in this table (%)	GWP relative to CO <sub>2</sub> (100 year IPCC values)	GWP value (g CO <sub>2</sub> -equivalent/kg of H <sub>2</sub> )	Percent contribution to GWP (%)
CO <sub>2</sub>	10,621	99.4	1	10,621	89.3
CH <sub>4</sub>	60	0.6	21	1,256	10.6
N <sub>2</sub> O	0.04	0.0003	310	11	0.1
GWP	N/A	N/A	N/A	11,888	N/A

The following figure provides an **allocation of GWP** over the life cycle:

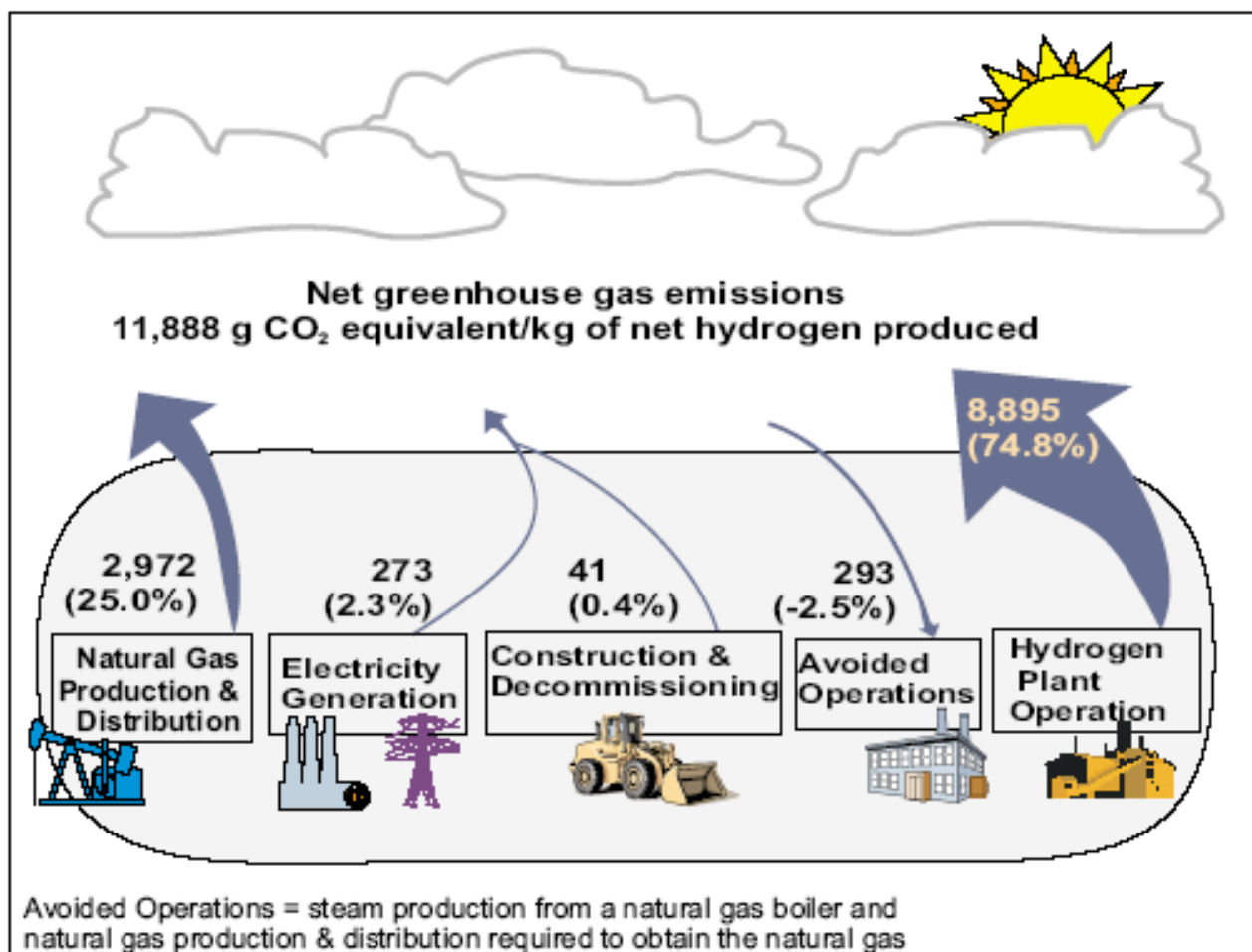

It is clear that the largest part (**nearly 75%**) of GWP is coming from plant operation; yet the second largest contribution (**25%**) is connected with natural gas production and transport.

**FUNCTIONAL UNIT = 1 kg H<sub>2</sub>.**

The **Energy Balance** is a key part of a traditional Life Cycle Analysis (Phase: Life Cycle Interpretation).

The use of energy from inputs to final output ( 1kg H<sub>2</sub> = 142 MJ HHV basis; 1kg H<sub>2</sub> = 120 MJ LHV basis) is summarized in the following table, which is recording separately energy contained in the natural gas feedstock and non-feedstock energy (coal etc. for electricity grid generation; natural gas losses during production & transport):

**Table 6: Average Energy Requirements (LHV basis)**

	System total energy consumption (MJ/kg H <sub>2</sub> )	% of total in this table	% of total from construction & decommissioning	% of total from natural gas production & distribution	% of total from electricity generation	% of total from avoided operations
Energy in the natural gas to hydrogen plant	159.6	87.1%	N/A	100.0%	N/A	N/A
Non-feedstock energy consumed by system (*)	23.6	12.9%	2.4%	169.8%	17.0%	-89.3%
Total energy consumed by system	183.2	N/A	N/A	N/A	N/A	N/A

\* Excludes the energy in the natural gas feedstock energy but includes the energy in the natural gas lost to the atmosphere during natural gas production.

The table is recording as a negative value the avoided operation connected to the production of 1855 Mg/day of high-pressure steam. The data in the table can be used to calculate a set of non-dimensional energy performance indicators:

**Table 7: Energy Efficiency and Ratio Definitions (LHV basis)**

Life cycle efficiency (%) (a)	External energy efficiency (%) (b)	Net energy ratio (c)	External energy ratio (d)
$\eta_{LC} = \frac{E_{h2} - E_u - E_f}{E_f}$	$\eta_{Ext} = \frac{E_{h2} - E_u}{E_f}$	$NER = \frac{E_{h2}}{E_{ff}}$	$EER = \frac{E_{h2}}{E_{ff} - E_f}$
where: E <sub>h2</sub> = energy in the hydrogen E <sub>u</sub> = energy consumed by all upstream processes required to operate the hydrogen plant E <sub>f</sub> = energy contained in the natural gas fed to the hydrogen plant E <sub>ff</sub> = fossil fuel energy consumed within the system (e)			

- (a) Includes the energy consumed by all of the processes.
- (b) Excludes the heating value of the natural gas feedstock from the life cycle efficiency formula.
- (c) Illustrates how much energy is produced for each unit of fossil fuel energy consumed.
- (d) Excludes the energy of the natural gas to the hydrogen plant.
- (e) Includes the natural gas fed to the hydrogen plant since it is consumed within the boundaries of the system.

The results of the computation are the following:

**Table 8: Energy Balance Results (LHV basis)**

		Base case result
Life cycle efficiency	$\eta_{LC}$	-39.6%
External energy efficiency	$\eta_{Ext}$	60.4%
Net energy ratio	NER	0.66
External energy ratio	EER	5.1

It is not surprising to get a result of negative **Life Cycle Efficiency** (which is a common case in most applications with fossil fuels, that is, non-renewable resources): **the energy in the natural gas feedstock is larger than the energy content of the hydrogen produced.**

The **Net Energy Ratio** is a relevant indicator for end-users of the Hydrogen. For each MJ of fossil fuel consumed in the H<sub>2</sub> energy production system, only 0.66 MJ are available as energy carrier in the outlet Hydrogen stream. 34% of the fossil fuel energy is wasted in the process of transformation into hydrogen.

The **External Energy Efficiency** does not consider as an input the energy content of the natural gas feedstock, which is seen just **as a product to be transformed** by processes consuming external energy supply: this is why a positive value (60.4%) is obtained. **The fact that this value is much smaller than the Hydrogen Plant Energy Efficiency previously defined (and calculated in Table 1 at 89%) reflects the use of energy in upstream processes (natural gas production and transport, including losses), which are not accounted for at plant level.**

The **External Energy Ratio** indicates that the product (Hydrogen) is valuable, because its energy value is 5 times larger than the external energy which was used for transforming natural gas into a cleaner fuel.

The Life Cycle efficiency and the Net Energy Ratio are correct indicators of system performance; however, the external variables are relevant because they provide a measure of the rate of energy consumption of the upstream processes.

Another part of LCA interpretation is evaluation of **Resource Consumption**: this includes fossil fuels and minerals (ore and scrap recycled from external processes), as well as water consumption. The results of the LCA Inventory Analysis for resources are summarized in the following tables:

**Table 9: Average Resource Consumption**

Resource	total (g/kg H <sub>2</sub> )	% of Total in this table	% of total from construction & decommissioning	% of total from natural gas production & transport	% of total from electricity generation	% of total from avoided operations
Coal (in ground)	159.2	4.1%	7.1%	17.4%	77.2%	-1.7%
Iron (Fe, ore)	10.3	0.3%	100.0%	0.0%	0.0%	0.0%
Iron scrap	11.2	0.3%	100.0%	0.0%	0.0%	0.0%
Limestone (CaCO <sub>3</sub> , in ground)	16.0	0.4%	100.0%	0.0%	0.0%	0.0%
Natural gas (in ground)	3,642.3	94.5%	< 0.0%	110.8%	0.1%	-10.9%
Oil (in ground)	16.4	0.4%	30.0%	60.8%	15.1%	-6.0%

**Table 11: Breakdown of Hydrogen Plant Water Consumption**

	Amount consumed (liters/kg H <sub>2</sub> )	% of total water consumption
Water consumed in reforming & shift reactions	4.8	24.0%
Water consumed in 4.8 MPa steam production	14.1	71.2%
Total water consumption from hydrogen plant	18.8	95.2%

The main issue in consumption of resources is that of fossil fuels, which are consumed and transformed by the system. Other resources play a minor role.

Water consumption would be much lower if the condensate from the 4.8MPa steam flow rate were recuperated in a closed circuit (but this depends on the type of external user).

**Water Emissions** (sewage) and **Solid Waste** (non-toxic and non-hazardous in this plant) were also evaluated, and found to be very small; moreover these emissions were mainly due to production and transport of natural gas, so that they are basically shared with any process making use of natural gas.

The study is completed by a **Sensitivity Analysis**, examining the effect of how uncertainties in basic variables and assumptions, as well as different scenarios, can affect the final results. These results are not reported in this summary.

The **Impact Assessment** is performed mainly through the discussion of GWP and Energy utilization; moreover, **stressor categories** for the process are identified (**SETAC/TEAM**) and their potential issues and area impacted are indicated, as shown in the following table:

**Table 15: Impacts Associated with Stressor Categories**

Stressor categories		Stressors	Major impact category H = human health E = ecological health	Area impacted L = local (country) R = regional (state) G = global
Major	Minor			
Ozone depletion compounds		NO	H, E	R, G
Climate change	Greenhouse gases	CO <sub>2</sub> , CH <sub>4</sub> , N <sub>2</sub> O, CO and NO <sub>x</sub> (indirectly), water vapor	H, E	R, G
	Particulates		H, E	L, R
Contributors to smog	Photochemical	NO <sub>x</sub> , VOCs	H, E	L, R
Acidification precursors		SO <sub>2</sub> , NO <sub>x</sub> , CO <sub>2</sub>	H, E	L, R
Contributors to corrosion		SO <sub>2</sub> , H <sub>2</sub> S, H <sub>2</sub> O	E	L
Other stressors with toxic effects		NMHCs, benzene	H, E	L
Resource depletion		Fossil fuels, water, minerals, and ores	E	R, G
Solid waste		Catalysts, coal ash (indirectly), flue gas clean up waste (indirectly)	H, E	L, R

**Improvement Opportunities** are finally identified: the process appears to be highly efficient (in particular after addition of the Low-Temperature Shift reactor, which was an improvement with respect to previous designs). Improvement should rather be sought in external processes: for example, **the GWP result could be improved reducing the natural gas dispersion from production/transport (1.4% in this study), which is responsible for 11% of the overall GWP issue.** This value would be reduced to 6% if losses were 0.5% instead of 1.4%. Also the energy consumption would benefit from reduction of these losses. Application of CO<sub>2</sub> sequestration downstream of the process, rather than emitting CO<sub>2</sub> to the environment, would radically change the GWP result which is the largest concern in this LCA.

**Conclusions** resume of results: the main issue is CO<sub>2</sub> emissions and the associated GWP. From the point of view of energy, only 66% of the energy input is made available in the product (Hydrogen). This confirms a common view: Hydrogen represents a key solution for transport applications (cars, trucks, airplanes, ...) where reduced pollution is a must, but it is an expensive energy carrier and it is presently wrong to consider it as a “clean” fuel as its production with current methods (reforming of natural gas) involves consistent energy losses. This scenario would change partly considering the possibility of applying reliable CO<sub>2</sub> sequestration; and completely if Hydrogen were produced by nuclear or renewable energies (photovoltaics, solar thermal, biomass,.....).

## **A.4 LCA and ELCA of the disposable cup and the porcelain mug**

### **A.4.1 Presentation of the case study**

The present case study is taken from **Chapter 9 of the PhD Thesis of René Cornelissen** [12]. In his work Cornelissen is discussing methodologies to unify exergy analysis and Life Cycle Analysis, and he presents several examples comparing LCA and ELCA. Among these examples the most complete one – up to considering Zero-ELCA for a zero emission process - is that analyzing the alternative use of **disposable plastic (polystyrene) cups (DPC)** or of a **re-usable porcelain mug (RUPM)** for coffee in common facilities, such as University canteens or catering services.

The LCA was performed using the SimaPRO 3.1 software, both for inventory analysis and for Impact assessment. The software includes normalization in the 9 categories and weighting for the ECO-Indicator 95 score.

The **functional unit** was taken at **3000 cups for the DPC**, to be compared to an use of 3000 times of the RUPM before this last is damaged and unusable.

Plastic cups are 49% High Impact Polystyrene; 49% General Purpose Polystyrene; 2% TiO<sub>2</sub> used as color. The total mass is 4g. The production process (extrusion) uses **4 MJ per kg of cups (250 cups)**. The disposal scenario is 48% incineration and 52% dumping (Netherlands, 1995).

The porcelain mug uses a mixture of minerals: kaolin (50%), feldspar (25%) and quartz (25%). The basic constituents of these compounds are Al<sub>2</sub>O<sub>3</sub> and SiO<sub>2</sub>. The production process uses a 900°C furnace for the first cooking the cup; then glazing is added and a second oven treatment at 1400°C follows for enamel covering. The mass of one cup is 250g. Its production needs 1 m<sup>3</sup> of natural gas. After each use the mug is washed in a dishwasher, using a **detergent with 30% of phosphates**. The energy consumption for mug washing is 45kJ and the detergent use 0,25g. At the end of its life the mug is dumped in a waste site.

#### A.4.2 Results of the Life Cycle Analysis

The results of the inventory analysis in terms of raw materials is summarized in the following table for the two processes (3000 disposable plastic cups and 1 porcelain mug):

*Table 9.2 Raw materials inputs of both life cycles in kg*

inputs	LC 3000 PS cups	LC porcelain mug
bauxite (ore)	2.23e-02	0
clay	2.35e-04	2.53e-01
coal	3.78e-01	4.38e+00
ilmenite	4.80e-01	0
iron (ore)	4.25e-03	0
limestone mineral	6.31e-03	0
natural gas	4.30e-01	6.73e+00
crude oil	2.36e+01	1.44e-03
rock salt	4.28e-01	0

Emissions to air and water are collected in two separate table for the two processes; the table is showing also the buildup of the ECO\_Indicator95 score:

Table 9.3 Emissions to air and water for life cycle of the porcelain mug

emitted substance	emitted to	Mass (kg)	Eco-indicator 95	% of total	cumulative %
NO	air	1.72e-01	1.36e-02	37.269	37.269
SO <sub>2</sub>	air	6.58e-02	9.33e-03	25.568	62.837
phosphate	water	4.50e-02	5.89e-03	16.141	78.978
CO <sub>2</sub>	air	2.96e+01	5.67e-03	15.538	94.517
C <sub>x</sub> H <sub>y</sub>	air	2.34e-02	1.30e-03	3.563	98.079
dust (SPM)	air	5.63e-03	2.98e-04	0.817	98.896
N <sub>2</sub> O	air	4.55e-03	2.35e-04	0.644	99.540
methane	air	4.29e-02	1.32e-04	0.362	99.901
ammonia	air	1.20e-04	2.53e-05	0.069	99.971
Pb	water	7.50e-08	6.90e-06	0.019	99.990
aldehydes	air	4.04e-05	2.50e-06	0.007	99.996
Ba	water	1.00e-07	1.28e-06	0.004	100.000
CO	air	2.10e-02			
Total			3.649e-02		

Table 9.4 Emissions to air and water for life cycle of 3000 PS cups

emitted substance	emitted to	Mass [kg]	Eco-indicator 95	% of total	cumulative
SO <sub>2</sub>	air	4.28e-01	6.07e-02	60.320	60.320
NO	air	3.04e-01	2.41e-02	23.973	84.293
CO <sub>2</sub>	air	5.51e+01	1.05e-02	10.445	94.738
C <sub>x</sub> H <sub>y</sub>	air	8.10e-02	4.49e-03	4.466	99.204
Cr	water	1.05e-05	1.94e-04	0.193	99.397
Pb	water	1.68e-06	1.55e-04	0.154	99.552
dust (SPM)	air	2.36e-03	1.25e-04	0.124	99.676
COD	water	1.88e-02	5.42e-05	0.054	99.730
heavy metals	air	5.77e-07	5.31e-05	0.053	99.783
HCl	air	6.15e-04	4.80e-05	0.048	99.830
toluene	air	4.78e-04	3.75e-05	0.037	99.868
NH <sub>4</sub> <sup>+</sup>	water	7.05e-04	3.05e-05	0.030	99.898
benzene	air	8.09e-04	2.95e-05	0.029	99.927
fluoranthene	air	2.88e-08	2.64e-05	0.026	99.954
N <sub>2</sub> O	air	2.48e-04	1.28e-05	0.013	99.966
methane	air	2.37e-03	7.30e-06	0.007	99.974
Cd	water	2.16e-08	5.96e-06	0.006	99.980
Hg	water	5.23e-09	4.81e-06	0.005	99.984
ethylbenzene	air	6.62e-05	4.15e-06	0.004	99.988
benzo[a]pyrene	air	2.88e-09	2.64e-06	0.003	99.991
styrene	air	2.42e-05	2.57e-06	0.003	99.994
HF	air	1.76e-05	2.50e-06	0.002	99.996
ammonia	air	8.90e-06	1.87e-06	0.002	99.998
carbon black	air	1.55e-05	8.24e-07	0.001	99.999
Cu	water	1.68e-06	7.74e-07	0.001	100.000
aldehydes	air	6.85e-06	4.24e-07	0.000	100.000
C <sub>x</sub> H <sub>y</sub> aromatic	air	3.88e-07			
CO	air	2.30e-02			
Total			1.0031e-01		



The production of waste is summarized as follows:

Table 9.5 Emissions to the soil for both life cycles in kg

Emission	LC 3000 PS cups	LC porcelain mug
chemical waste	2.40e-02	6.00e-04
final waste (inert)	6.24e+00	1.30e-01
production waste (not inert)	1.04e+00	2.37e+00
slag	1.15e-01	1.20e-01

The results of the ECO\_Indicator95 LCA are shown in the following figure for 9 categories (the units are those of the category indicator, normalized "Per European" PE as is required by the ECO\_Indicator95 methodology):

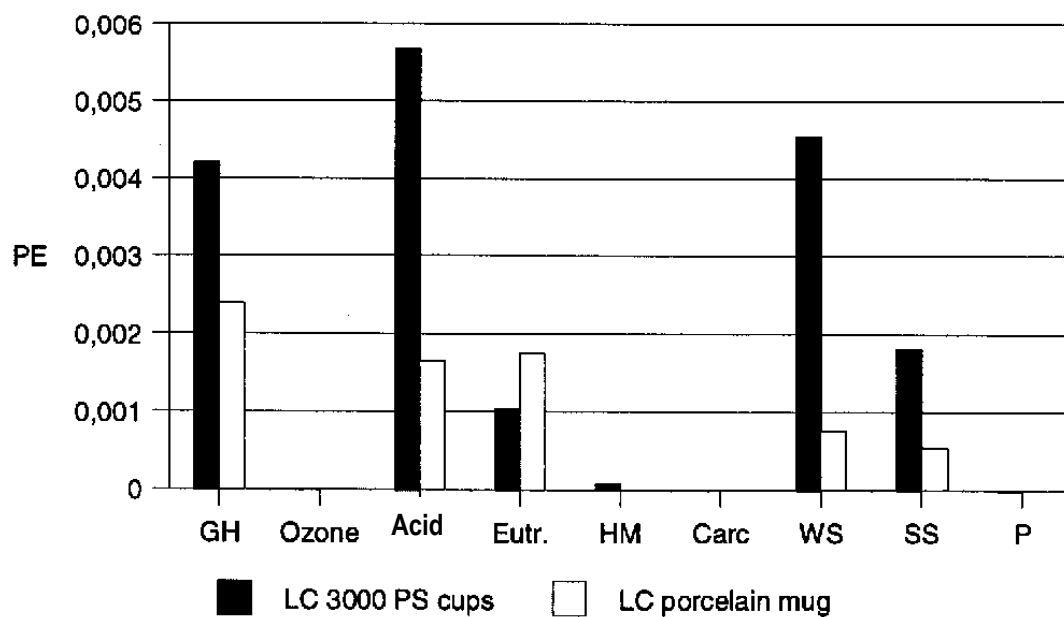

Table 9.6 The normalised values for the different environmental effects

The contribution of each category to the buildup of the ECO\_Indicator95 points is shown in the following figure:

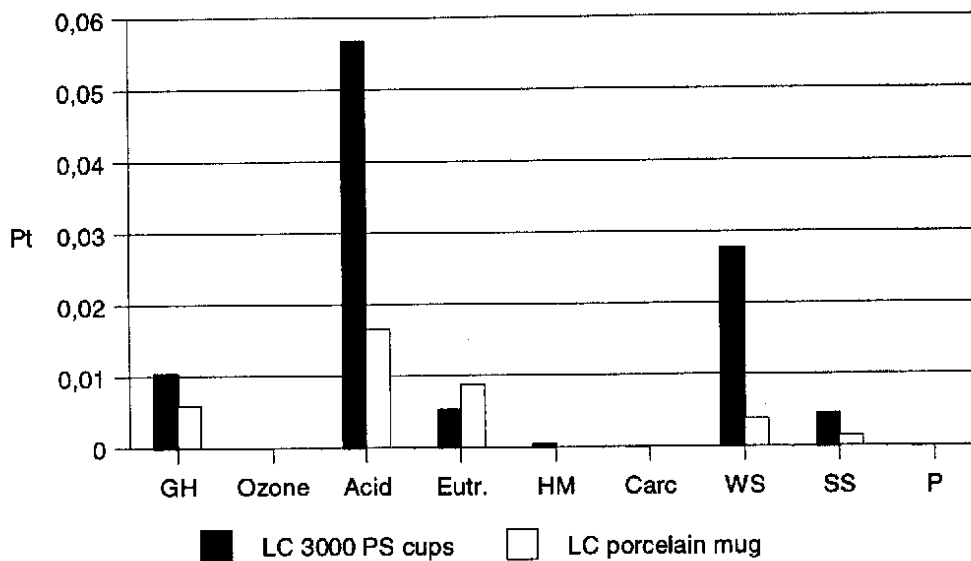

Table 9.7 The evaluated environmental effects according to the Eco-indicator 95

The LCA Interpretation shows that the RUPM is about 2.7 times more sustainable from the environmental point of view than the equivalent use of 3000 DPCs.

The results for the different categories are often shown in a spider net diagram:

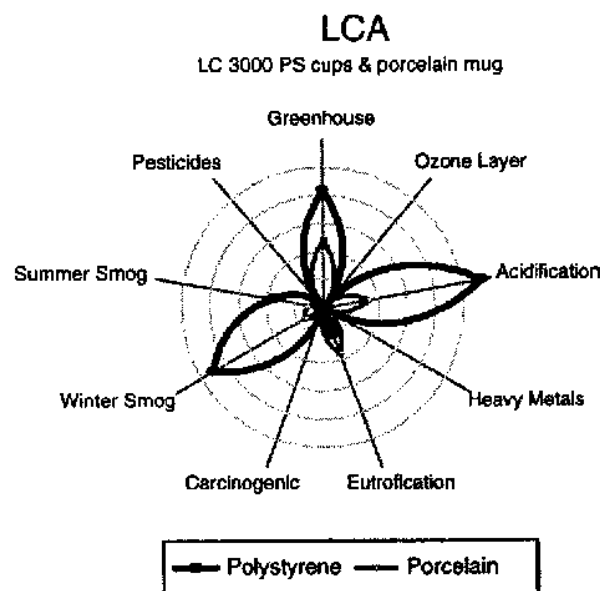

Figure 9.1 The normalised environmental effects, each circle is, starting from the center, an increase of 0.001 PE

Greenhouse, Acidification, Eutrophication, Winter and Summer Smog are the five significant categories; in the case of the DPC, these effects are due to SO<sub>2</sub>, NO<sub>x</sub> and CO<sub>2</sub>

emissions, and are all traceable to the production process of polystyrene. The same emissions cause environmental effects for the RUPM, with the addition of phosphates in the detergent used for mug washing over the life cycle (this category is the only one showing a larger environmental impact for the porcelain mug). Production of the porcelain mug brings a very limited contribution (<1%) to the final ECO\_Indicator95 score.

#### A.4.3 Results of the Exergetic Life Cycle Analysis

A simplified material flows inventory was used for the ELCA:

*Table 9.8 Main incoming flows of the two life cycles in kg*

Components	PS cup	porcelain mug
coal	0.378	4.700
crude oil	23.600	
natural gas	0.685	7.478
oxygen	63.961	34.615
phosphate		0.045
total	88.624	46.793

*Table 9.9 Main outgoing flows of the two life cycles in kg*

Components	PS cup	porcelain mug
CO <sub>2</sub>	55.100	29.600
H <sub>2</sub> O	26.520	14.773
SO <sub>2</sub>	0.428	0.066
PS waste	6.115	
NO	0.304	0.172
N <sub>2</sub>	0.020	1.701
ash	0.032	0.395
CO	0.023	0.021
C <sub>x</sub> H <sub>y</sub>	0.081	0.023
CH <sub>4</sub>		0.043
phosphate		0.045
total	88.624	46.793

The calculated exergy balances of the two processes are shown in the following figures:

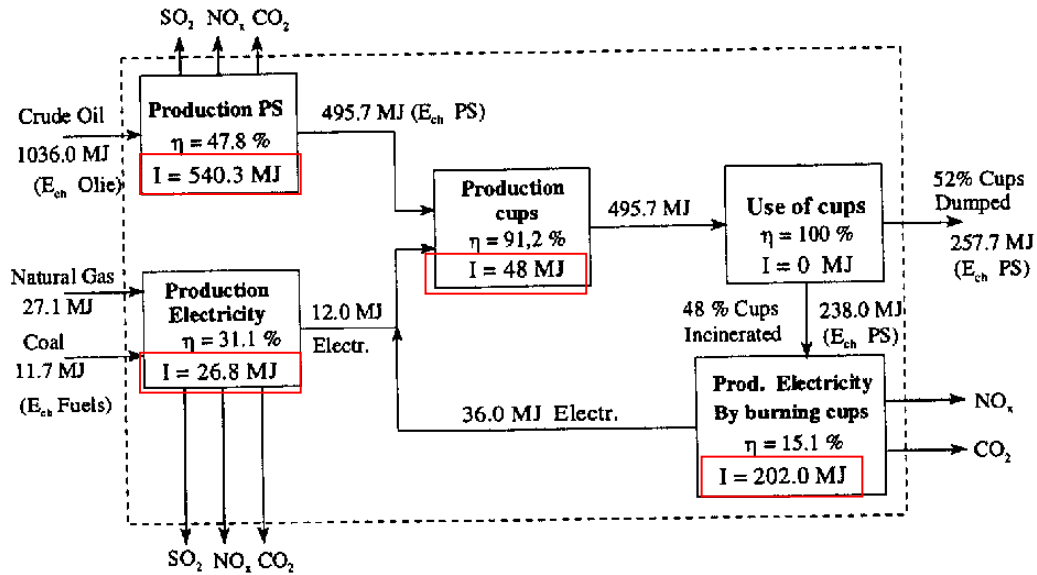

Figure 9.2 Exergy diagram of the life cycle of the 3000 disposable PS cups

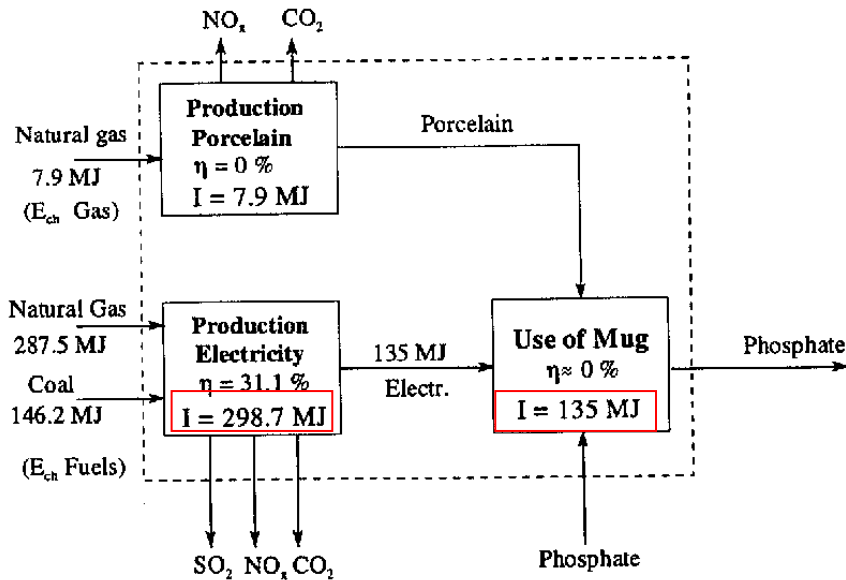

Figure 9.3 Exergy diagram of the life cycle of the porcelain mug

The two exergy diagrams show the **Irreversibility I** over the life cycle for each internal process; and the Inlet flows of exergy in the different streams. Only the exergy output of

polystyrene dumped at the waste site was taken into account at exit, because it represents a non-negligible exergy reservoir which could be considered for exploitation in the future. The **Cumulative Exergy Destruction** amounts to **817 MJ** for the 3000 disposable plastic cups, and at **442 MJ** for the porcelain mug (used 3000 times). This means an irreversibility 1.85 times smaller for the second process. The main ExDs in the disposable cup process are encountered in production of polystyrene and in burning the waste. The main ExDs in the porcelain mug process come from use of electricity and from the washing process.

#### A.4.3 Results of the Zero- Exergy Life Cycle Analysis (Zero-ELCA)

In order to perform a Zero-ELCA of a process, the production processes must be transformed in zero-exergy emission processes. The causes of pollution to the environment were identified as CO<sub>2</sub>, NO<sub>x</sub>, SO<sub>2</sub>, plus Phosphates for the porcelain mug. These emissions should be abated and the exergy consumed to achieve this goal should be accounted in a Zero-ELCA study. Abatement is here considered down to the environmentally acceptable value with current technology.

For SO<sub>2</sub> a process allowing 90% lime desulphurization of the flue gases was considered, consuming 57 MJ/(kg of SO<sub>2</sub>).

For NO<sub>x</sub> an 80% efficient catalytic DeNO<sub>x</sub> unit is considered consuming 16 MJ/(kg of NO<sub>x</sub>).

For separation of CO<sub>2</sub> a figure of 3 MJ/kg CO<sub>2</sub> was assumed, for a chemical scrubbing plant providing 90% removal efficiency. An associated penalty in the efficiency of converting fossil fuels to electricity is also present, evaluated at 15 percentage points in efficiency. 99% removal of phosphates is assumed to have an exergy cost of 18 MJ/kg. The overall exergy balance for avoiding these emissions for the two processes is resumed in the following table:

*Table 9.10 Abatement exergy of the main harmful emissions in MJ*

components	PS-cups	porcelain mug
CO <sub>2</sub>	148.8	79.9
SO <sub>2</sub>	22.0	3.4
NO <sub>x</sub>	3.9	2.2
phosphate		0.8
total	174.7	86.3

For the **DPC**, passing to a zero-emission (acceptable-emission) scenario involves an exergy increase of **174,7 MJ**, that is, an overall value of Cumulative Exergy Destruction **817 + 174,7 = 992 MJ**. For the **RUPM** the CexD over the Life cycle would be **442 + 86,3 = 528 MJ**. The relative increases in Cumulative Exergy destruction are about 20% in both cases, which leaves at 1.88 the ratio, always in favor of the re-usable mug. The improvement obtained is quantified by the comparison of the following figures:

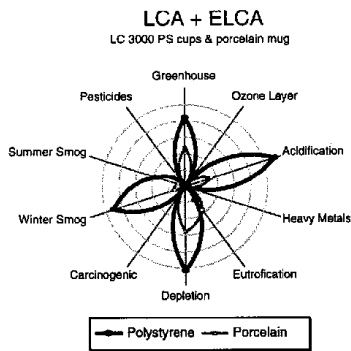

Figure 9.4 The normalised environmental effects, including depletion, each circle is, starting from the center, an increase of 0.001 PE.

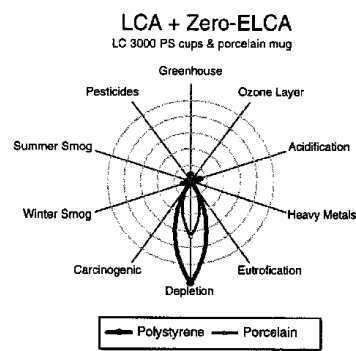
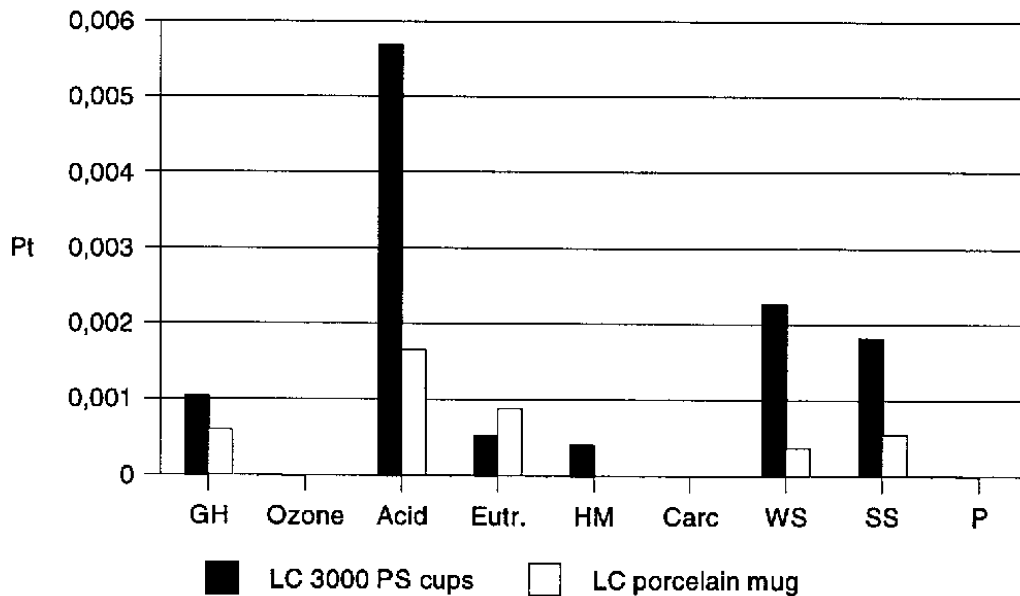

Figure 9.5 The normalised environmental effects in the Zero-ELCA, each circle is, starting from the center, an increase of 0.001 PE.

The “Per European” PE reference value for Resource depletion was assumed at **160GJ per European year (1987/1994 values)**. The final normalized score for the only category remaining after Zero-ELCA, that is, Energy (Exergy) Depletion, is 0,00511 PE for the disposable cups and 0,00276 for the re-usable porcelain mug. As Zero-ELCA has reduced the emissions to low (acceptable) values, but not eliminated them it makes sense to **go back to traditional LCA** for examining, **after emissions treatment at state of-the-art level** (and exergy consumption), what is the performance in the different categories. The application of weighting allows as usual to build the ECO\_Indicator95 score, which is reduced to 0,0104 for the disposable plastic cup, and 0,00365 for the re-usable porcelain mug. The buildup of the final score through contributions of the different categories is summarized in the following figure:



*Table 9.11 The evaluated environmental effects in the Zero-ELCA according to the Eco-indicator 95 method*

#### A.4.4 Conclusions– Disposable Plastic Cup DPC vs. Re-Usable Porcelain Mug RUPM

The LCA demonstrated that the use of DPC instead of a RUPM (including washing) has a higher environmental impact in 4 categories (Greenhouse, Acidification, Winter Smog and Summer smog); only for eutrophication the environmental performance is better for the disposable cup.

**The ELCA demonstrated that the DPC solution consumes in its life cycle 1,88 times the exergy consumed by the use of RUPM.**

The Zero-ELCA showed that for both processes an increase of about 20% of the exergy consumed over the life cycle could achieve the relevant goal of reducing the emission levels to the level corresponding to state-of-the-art of technical feasibility.

The indications of sources of damage to the environment are similar for the ECO\_Indicator95 (which is a subjective method) and for Zero-ELCA. This is due that in both cases the fundamental contributions to environmental impact is coming from airborne emissions to the environment caused by the combustion of fossil fuels.

## A5 – Analisi LCA (GEMIS/ECO\_INDICATOR95) di diversi impianti per produzione di energia elettrica da solare fotovoltaico

L'analisi è stata applicata ai seguenti sistemi di produzione di energia elettrica:

1. Energia elettrica prodotta da impianto fotovoltaico in silicio policristallino;
2. Energia elettrica prodotta da impianto fotovoltaico in silicio monocristallino;
3. Energia elettrica prodotta da impianto fotovoltaico in silicio amorfo;

### Confini dei sistemi analizzati

I confini del sistema analizzato sono definiti nel diagramma riportato in fig. A5.1. L'intero ciclo si svolge in un arco temporale di circa 20-35 anni, ipotizzando una vita degli impianti compresa fra i 20 ed i 30 anni.



Figura A5.1: Definizione dei confini di un sistema fotovoltaico (fonte [14])



## Funzione dei sistemi

I sistemi oggetto dello studio hanno la stessa funzione, ovvero *produzione in output di energia elettrica*. I quattro processi, pur fornendo lo stesso output, utilizzano come fonte energetica input diversi, ovvero energia solare nel caso dei tre sistemi fotovoltaici e combustibili tradizionali nel caso dell'energia prelevata dalla rete.

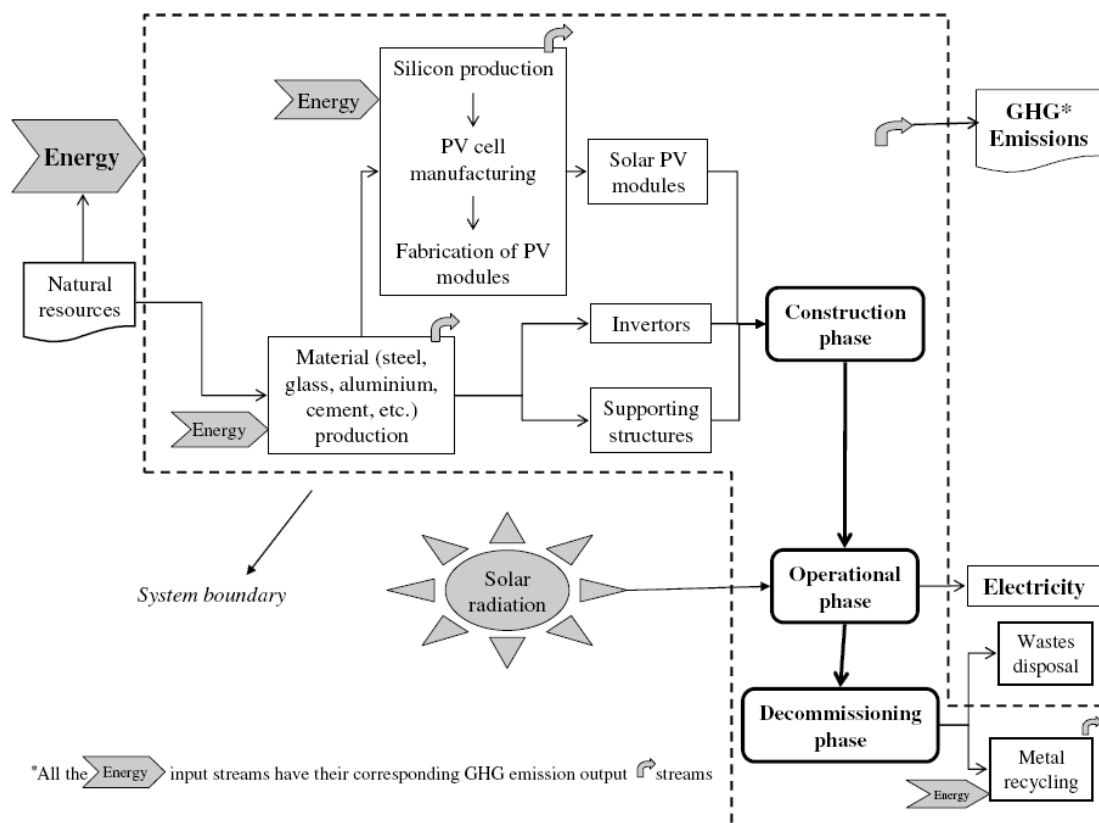
## Unità funzionale

Tutte le grandezze sono riportate all'unità funzionale di 1 kWh di corrente elettrica alternata (AC) prodotta.

## Tipologie di impatto

In questo studio vengono analizzati i seguenti impatti ambientali:

- Emissione di gas serra (GHG), in termini di CO<sub>2</sub> equivalente
- Consumo di energia primaria

Viene applicata la metodologia dell'Eco-Indicator 95 mediante l'analisi delle relative categorie di impatto.

## Ipotesi

Si considerano valide le seguenti ipotesi:

- i moduli fotovoltaici vengono realizzati in impianti di capacità produttive tecnologicamente ed economicamente convenienti, tipicamente almeno di taglia 25-30 MW di produzione annua
- soglia di sensibilità dello studio pari all'1%, vengono perciò considerati trascurabili tutti gli input ed output al di sotto di essa.

### A5.1 IMPIANTO SILICIO MONOCRISTALLINO

- **Moduli SHARP NU-S5E3E**

Per l'inventario dei moduli è stato utilizzato l'apposito processo predisposto in GEMIS 4.4 "*fabrication\silicon-modul-mono-DE-2005*". Su tale processo si è però ritenuto di intervenire al fine di simulare, per quanto possibile, la condizione reale di produzione dei pannelli fotovoltaici in Giappone modificando il mix energetico di input. A tale scopo è stato quindi creato un nuovo processo di produzione dei moduli ("*fabrication\silicon-modul-mono-sharp-japan*") che utilizza, come energia ausiliare di input, l'energia elettrica derivata dalla ricostruzione del mix energetico giapponese riportata in Tabella A5.1.

Carbone	21,78%
Gas naturale	13,19%
Petrolio e prodotti petroliferi	47,83%
Energia nucleare	13,81%
Energia idroelettrica	1,52%
Energia geotermica	0,58%
Energia eolica e solare	0,13%
Biomasse, biogas e rifiuti	1,16%

*TabellaA5.1: Ricostruzione del mix energetico giapponese utilizzata per la realizzazione del processo “electrical generation-mix-japan” (fonte ENEA [42])*

A seguito della creazione del processo “*electrical generation-mix-japan*” sono stati conseguentemente modificati tutti gli altri processi coinvolti nella fabbricazione del modulo fotovoltaico inserendo il nuovo input di approvvigionamento energetico. Si sono così ridefiniti i processi di fabbricazione del wafer monocristallino (processo “*fabrication\silicon-wafer-MONO-sharp-japan*”) e fabbricazione della cella (processo “*fabrication\silicon-cell-MONO-sharp-japan*”). Nella figura A5.2 si riporta la schematizzazione del processo così come rappresentata dal software GEMIS: sulla linea centrale del grafo vengono riportate le fasi principali del processo, sulla destra collegati in rosso gli input energetici e sulla sinistra collegati in blu gli input di materiali necessari allo svolgimento della fase del processo relativa.



Figura A5.2: Schematizzazione definita in GEMIS 4.4 del processo di fabbricazione dei moduli

Procedendo a ritroso nel processo, mediante il software, si esegue l'analisi di inventario per il modulo fotovoltaico. La struttura del software GEMIS richiede che i valori degli input siano espressi in termini di kg di materiale necessario e di kWh di energia necessari per la realizzazione di una porzione di un kg del modulo (le unità di misura relative sono quindi kg/kg e kWh/kg). Per facilità di lettura i dati della presente analisi sono invece riportati al modulo intero (un modulo SHARP NU-S5E3E di potenza di picco pari a 185 W ha il peso di 16 kg).

Materiale	Processo GEMIS	Q.tà (kg)
Celle fotovoltaiche silicio monocristallino	fabrication\silicon-cell-MONO-sharp-japan	0.699
Metanolo	chem-org\methanol-feedstock	0.015
Acqua	Xtra-drinking water\DE-general	24,185
Foglio per copertura posteriore moduli PV	chem-org\back foil for PV-modules-DE-2005	0.320
Polietilene	chem-org\polyphethyleneoxide	0.160
Alluminio	metal\Aluminium-mix-DE	3.520
Lastra di vetro	nonmetallic\minerals>window glass	10.400
EVA	chem-org\EVA	1.120
Rame	metal\copper-DE-mix	0.160
Kraftliner	pulp-paper\kraft liner-EU	1.280
Tipologia di energia	Processo GEMIS	Q.tà (kWh)
Energia elettrica	grid-el-distribution-MV-japan	7.68

Tabella A5.2: Materiale ed energia necessari per la realizzazione di un modulo fotovoltaico monocristallino da 185 Wp (dati GEMIS)

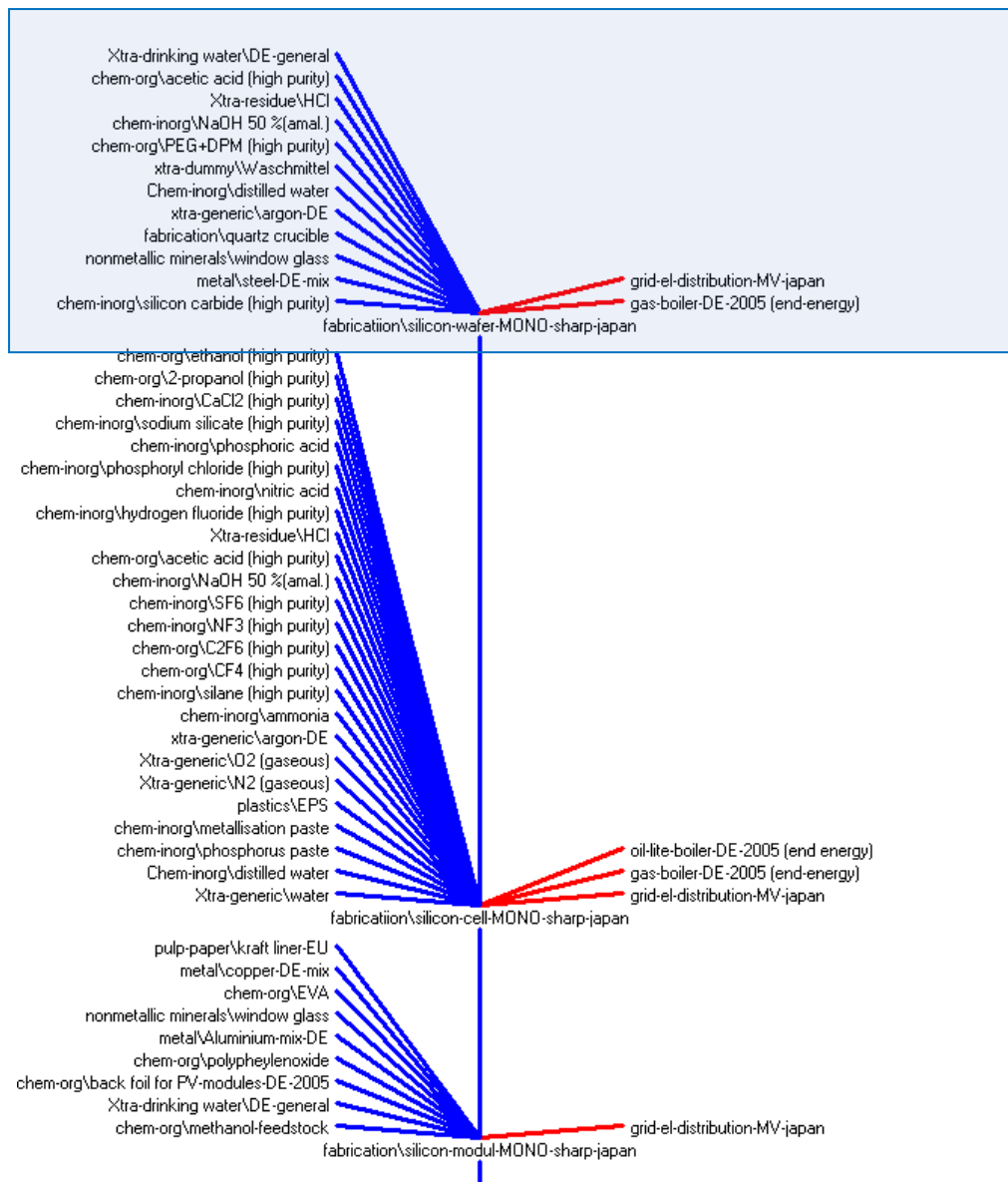
Nella tabelle seguenti si riporta l'analisi di inventario delle fasi relative a:

- o la produzione delle celle fotovoltaiche monocristalline (tabella A.5.3)
- o la realizzazione del wafer di silicio monocristallino (tabella A5.4)
- o la lavorazione del Si-EG (tabella A5.5)
- o la lavorazione del Si-MG (tabella A5.6)



Figura A5.3: Schematizzazione GEMIS 4.4 del processo di produzione dei wafer

<b>Materiale</b>	<b>Processo GEMIS</b>	<b>Q.tà (kg/mod)</b>
Wafer monocristallino	Fabrication\silicon-wafer-MONO-sharp-japan	0.741
Acqua	Xtra-drinking water\DE-general	1055.5
Acqua distillata	Chem-inorg\distilled water	145.4
Pasta di fosforo	chem-inorg\phosphorus paste	0.0015
Pasta metallica	chem-inorg\metallisation paste	0.0790
EPS	plastics\EPS	0.0004
N2 (gas)	Xtra-generic\N2 (gaseous)	1.9502
O2 (gas)	Xtra-generic\O2 (gaseous)	0.1069
Argon	xtra-generic\argon-DE	0.0271
Ammoniaca	chem-inorg\ammonia	0.0071
Silano (elevata purezza)	chem-inorg\silane (high purity)	0.0013
CF4 (elevata purezza)	chem-org\CF4 (high purity)	0.0008
C2F6 (elevata purezza)	chem-org\C2F6 (high purity)	0.0008
NF3 (elevata purezza)	chem-inorg\NF3 (high purity)	0.0008
SF6 (elevata purezza)	chem-inorg\SF6 (high purity)	0.0008
NaOH	chem-inorg\NaOH 50 %(amal.)	0.3299
Acido acetico (elevata purezza)	chem-org\acetic acid (high purity)	0.0030
HCl	Xtra-residue\HCl	0.0480
Acido idrofluoridrico (elevata purezza)	chem-inorg\hydrogen fluoride (high purity)	0.0199
Acido nitrico	chem-inorg\nitric acid	0.0563
phosphoryl chloride (elevata purezza)	chem-inorg\phosphoryl chloride (high purity)	0.0002
Acido fosforico	chem-inorg\phosphoric acid	0.0080
Silicato di sodio (elevata purezza)	chem-inorg\sodium silicate (high purity)	0.0790
CaCl2 (elevata purezza)	chem-inorg\CaCl2 (high purity)	0.0227
Propanolo	chem-org\2-propanol (high purity)	0.0832
Etanolo (elevata purezza)	chem-org\ethanol (high purity)	0.0007
<b>Tipologia di energia</b>	<b>Processo GEMIS</b>	<b>Q.tà (kWh/mod)</b>
Energia elettrica	grid-el-distribution-MV-japan	39.773
Calore	gas-boiler-2005 (end-energy)	1.391
Calore	oil-lite-boiler-2005 (end-energy)	0.340

*Tabella A5.3: Materiale ed energia necessari per la realizzazione delle celle di un modulo fotovoltaico monocristallino da 185 Wp (dati GEMIS)*

<b>Materiale</b>	<b>Processo GEMIS</b>	<b>Q.tà (kg/mod)</b>
Silicio EG	Fabrication\silicon-EG-japan	1.673
silicon carbide (high purity)	chem-inorg\silicon carbide (high purity)	2.290
Steel	metal\steel-DE-mix	1.578
glass flat	nonmetallic minerals>window glass	0.010
quartz crucible	fabrication\quartz crucible	0.378
Argon	xtra-generic\argon-DE	6.565
water (material)	Chem-inorg\distilled water	68.839
Detergents	xtra-dummy\Waschmittel	0.252
PEG+DPM (high purity)	chem-org\PEG+DPM (high purity)	3.105
NaOH	chem-inorg\NaOH 50 %(amal.)	0.031
HCl	Xtra-residue\HCl	0.003
Acetic acid (high purity)	chem-org\acetic acid (high purity)	0.041
water (material)	Xtra-drinking water\DE-general	0.006
<b>Tipologia di energia</b>	<b>Processo GEMIS</b>	<b>Q.tà (kWh/mod)</b>
Energia elettrica	grid-el-distribution-MV-japan	153.387
Calore	gas-boiler-2005 (end-energy)	22.64

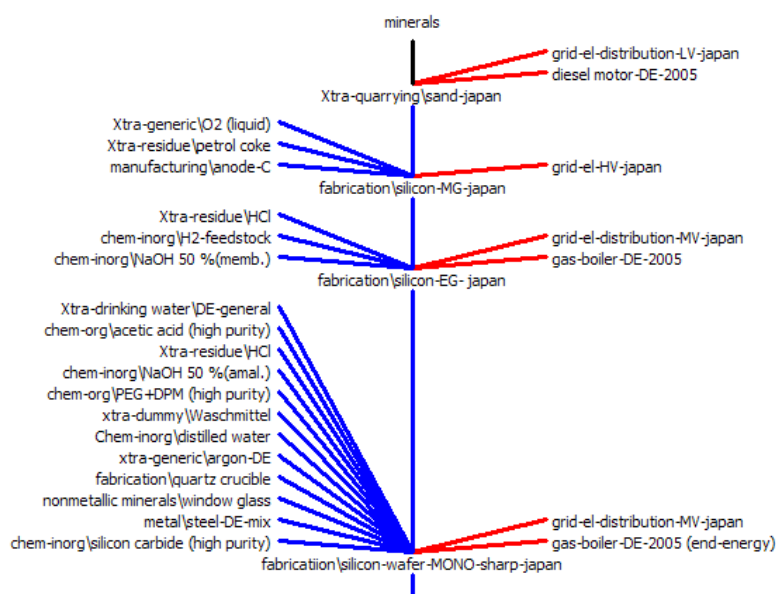
*Tabella A5.4: Materiale ed energia necessari per la realizzazione del wafer di un modulo fotovoltaico monocristallino da 185 Wp (dati GEMIS)*

<b>Materiale</b>	<b>Processo GEMIS</b>	<b>Q.tà (kg/mod)</b>
Silicio MG	Fabrication\silicon-MG-japan	1.891
NaOH	chem-inorg\NaOH 50 %(memb.)	1.104
H2 (material)	chem-inorg\H2-feedstock	1.121
HCl	Xtra-residue\HCl	1.121
<b>Tipologia di energia</b>	<b>Processo GEMIS</b>	<b>Q.tà (kWh/mod)</b>
Energia elettrica	grid-el-distribution-MV-japan	184.030
Calore	gas-boiler-2005 (end-energy)	85.992

*Tabella A5.5: Materiale ed energia necessari per la realizzazione del Si-EG di un modulo fotovoltaico monocristallino da 185 Wp (dati GEMIS)*

<b>Materiale</b>	<b>Processo GEMIS</b>	<b>Q.tà (kg/mod)</b>
Sabbia	Xtra-quarrying\sand-japan	5.480
anodes-C	manufacturing\anode-C	0.170
petrol coke	Xtra-residue\petrol coke	0.756
O2 (liquid)	Xtra-generic\O2 (liquid)	0.038
<b>Tipologia di energia</b>	<b>Processo GEMIS</b>	<b>Q.tà (kWh)</b>
Energia elettrica	grid-el-HV-japan	26.266

*Tabella A5.6: Materiale ed energia necessari per la realizzazione del Si-MG di un modulo fotovoltaico monocristallino da 185 Wp (dati GEMIS)*

La tabella ed i grafici seguenti riportano i valori del Global Warming Potential (espresso in kg di CO<sub>2</sub> equivalente) e del Cumulated Energy Requirement (kWh), per la produzione di **un modulo fotovoltaico da 185 Wp del peso totale di 16 kg.**

<b>Fase del processo</b>	<b>CO2 (kg)</b>	<b>CER (kWh)</b>
estrazione sabbia	0.04	0.13
lavorazione Si-MG	26.96	82.30
lavorazione Si-EG	175.53	722.61
fabbricazione wafer	182.99	829.79
fabbricazione celle	103.76	468.72
fabbricazione modulo	86.89	296.30
<b>totale</b>	<b>576.16</b>	<b>2399.86</b>

*Tabella A5.7: Global Warming Potential e Cumulated Energy Requirement - produzione di un modulo FV monocristallino - mix energetico giapponese (GEMIS)*

Si può osservare come le fasi di **produzione del Si-EG** e quella di **lavorazione del wafer** risultino decisamente le più gravose.



Figura A5.4: elaborazione dei risultati ottenuti dalle simulazioni GEMIS

Si osserva inoltre come l'utilizzo del mix energetico giapponese abbia un'incidenza significativa: se si prende infatti come esempio il processo predefinito in GEMIS che utilizza il mix energetico tedesco si osserva una riduzione della CER pari a circa il 6% (2270 invece di 2400 kWh)

## A5.2 CONFRONTO LCA TRA IMPIANTI PV CON DIVERSE TECNOLOGIE

In modo del tutto analogo, è stata condotta la fase d'inventario e l'analisi LCA per le altre due tipologie d'impianto (silicio policristallino ed amorfo). In ciascun caso gli impianti sono stati completati dell'inverter. Dopo aver ricostruito l'inventario dell'intero ciclo di vita dei tre impianti all'interno del software, si è proceduto creando in GEMIS uno scenario che ponesse a confronto, in termini di impatto ambientale, l'energia elettrica prodotta dai tre sistemi fotovoltaici analizzati con quella prelevata dalla rete e prodotta secondo il mix energetico italiano.

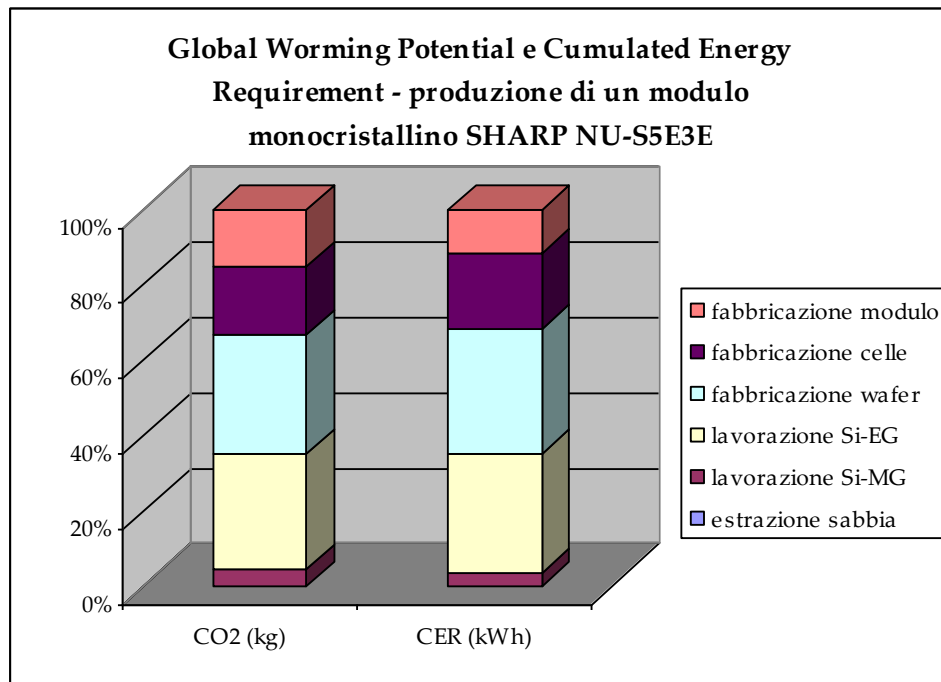
### A5.2.1 EMISSIONE DI GAS-SERRA

Data l'importanza fondamentale di questo parametro, anche in relazione agli obiettivi imposti dal protocollo di Kyoto, si è effettuato un primo confronto in termini di emissioni di gas serra dei quattro processi.



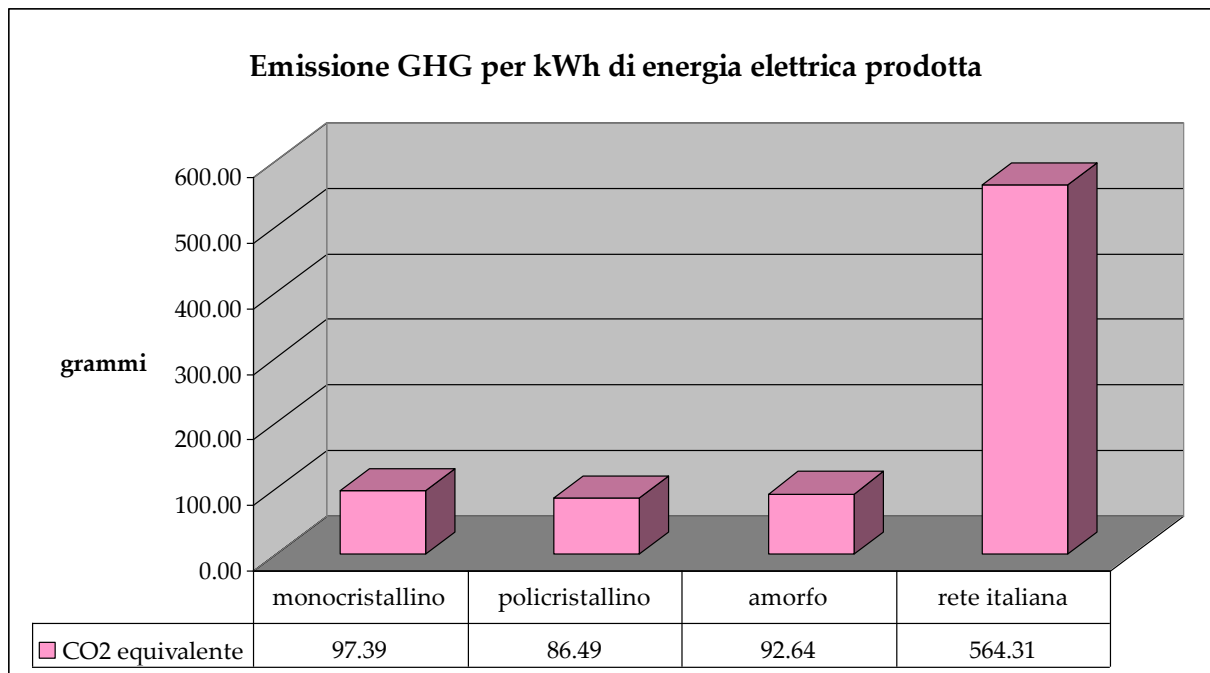

*Figura A5.5: confronto emissioni di gas-serra espresse in grammi di CO<sub>2</sub> equivalente per kWh*

Dal grafico si osserva come l'emissione di GHG dovuta alla produzione di un kWh di energia elettrica da fotovoltaico risulti oltre cinque volte inferiore a quella dovuta alla produzione della stessa quantità di energia secondo il mix energetico italiano.

A completamento di quanto indicato nel grafico di figura 6.8 si riportano nella tabella seguente i valori delle emissioni dei singoli gas-serra individuati da GEMIS come prodotti dei quattro processi analizzati. Il valore delle emissioni di GHG, espresso in termini di CO<sub>2</sub> equivalente, è stato quindi calcolato considerando il *Global Warming Potential* (relativo ad un orizzonte di 100 anni) di ognuno di essi. I gas rilevati sono dunque i seguenti:

- anidride carbonica (CO<sub>2</sub>) – GWP<sub>100</sub> = 1;
- metano (CH<sub>4</sub>) – GWP<sub>100</sub> = 21;
- protossido di azoto (N<sub>2</sub>O) – GWP<sub>100</sub> = 310;
- perfluorometano (CF<sub>4</sub>) – GWP<sub>100</sub> = 6500;
- perfluoroetano (C<sub>2</sub>F<sub>6</sub>) – GWP<sub>100</sub> = 9200.

	CO <sub>2</sub> (g/kWh)	CH <sub>4</sub> (g/kWh)	N <sub>2</sub> O (g/kWh)	CF <sub>4</sub> (g/kWh)	C <sub>2</sub> F <sub>6</sub> (g/kWh)
<b>monocristallino</b>	87.99	0.28	0.0025	0.000296	0.000037
<b>policristallino</b>	77.88	0.25	0.0022	0.000303	0.000038
<b>amorfo</b>	85.89	0.21	0.0043	0.000079	0.000009
<b>rete italiana</b>	539.83	0.76	0.0237	0.00000026	0.000000033

Tabella A5.7: confronto gas-serra espresse in grammi di sostanza per kWh di energia elettrica prodotta

### A5.2.3 METODOLOGIA ECO-INDICATOR 95

Al fine di individuare un unico indicatore che riassume tutti gli impatti individuati e confrontare così i quattro processi, tenendo conto della globalità degli effetti da essi prodotti sull'ambiente, è stata applicata la metodologia per la valutazione del ciclo di vita dell'Eco-Indicator 95. L'Eco-Indicator relativo all'energia elettrica prodotta secondo l'energy mix italiano ha un Eco-Indicator pari a più di cinque volte quello dell'energia elettrica prodotta da fotovoltaico.



Figura A5.6: confronto Eco-Indicator 95 per kWh (2007)

#### A5.2.4 CONFRONTO FRA I SISTEMI FOTOVOLTAICI

Il confronto in termini di CO<sub>2</sub> equivalente è stato esteso ad analizzare il contributo delle singole fasi del ciclo di vita per evidenziare le criticità ed individuare eventuali aree di miglioramento.

Ulteriori simulazioni effettuate con GEMIS hanno suddiviso il quantitativo, precedentemente calcolato, di CO<sub>2</sub> emessa per kWh di energia prodotta da fotovoltaico nelle seguenti fasi:

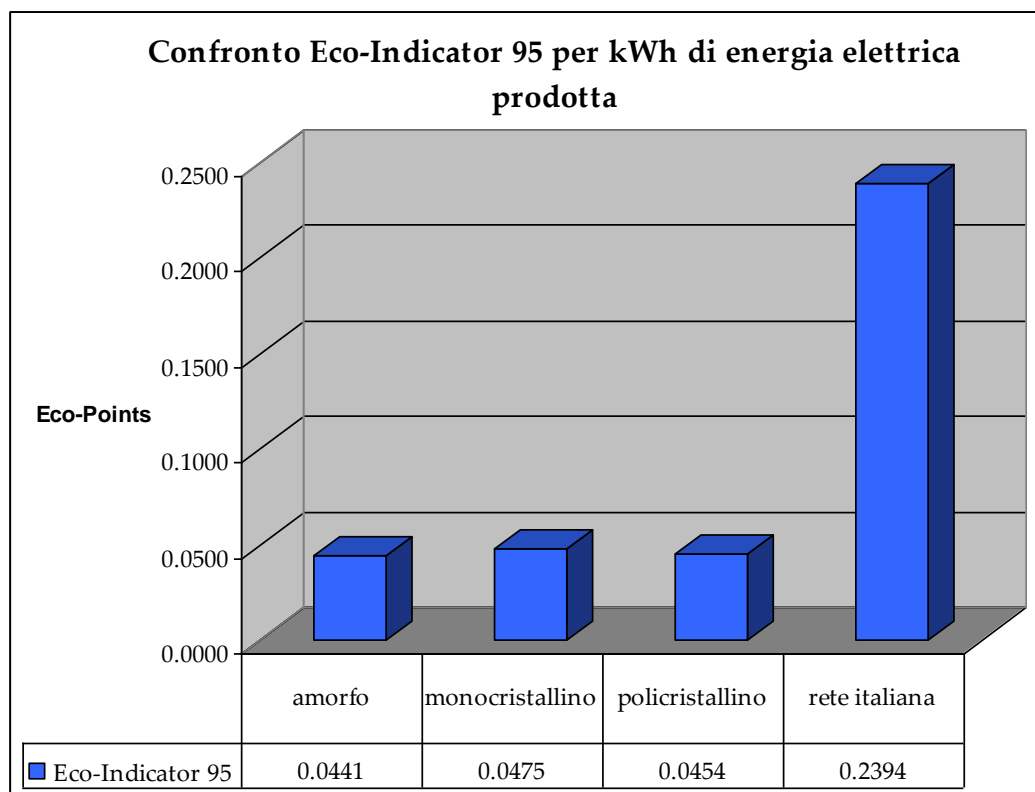
1. Produzione dei moduli fotovoltaici
2. Fabbricazione delle componenti che costituiscono il BOS
3. Trasporto dei materiali
4. Manutenzione dell'impianto
5. Smaltimento dei rifiuti prodotti dallo smantellamento dell'impianto.

I risultati dell'analisi sono riportati nella tabella A5.8 e seguente:

<b>grammi CO<sub>2</sub> equiv.</b>	<b>monocristallino</b>	<b>policristallino</b>	<b>amorfo</b>
<b>Produzione moduli</b>	81.10	72.36	81.28
<b>Fabbricazione BOS</b>	10.16	8.86	2.68
<b>Trasporti</b>	0.35	0.33	0.28
<b>Manutenzione</b>	4.62	4.01	6.00
<b>Smaltimento rifiuti</b>	1.16	0.93	2.40
<b>TOT.</b>	<b>97.39</b>	<b>86.49</b>	<b>92.64</b>

*Tabella A5.8: confronto emissioni CO<sub>2</sub> equivalente per kWh di energia prodotta (elaborazione dei risultati delle simulazioni effettuate con GEMIS 4.4)*

Dall'osservazione dei risultati dei confronti in termini di Eco-Indicator e di CO<sub>2</sub> equivalente emessa consegue che:

1. le tre tipologie di impianto risultano sostanzialmente equivalenti da un punto di vista di compatibilità ambientale;
2. l'impatto del trasporto dei materiali (materiali per la costruzione dell'impianto, per la manutenzione e rifiuti) rimane al di sotto della fascia di significatività

- scelta dell'1% e sarà quindi considerato inglobato nelle relative fasi di installazione, manutenzione e smaltimento;
- l'impatto notevolmente minore della fabbricazione BOS nell'impianto in silicio amorfo è da imputarsi alla mancanza di struttura portante;
  - l'impatto notevolmente maggiore dello smaltimento dei rifiuti sull'impianto in silicio amorfo è sicuramente da imputarsi al diverso scenario di smaltimento definito nonché alla durata più breve dell'impianto.



Figura A5.7: confronto emissioni CO<sub>2</sub> equivalente per kWh di energia prodotta

## A6 – Exergy, Exergo-Economic and ExergoEnvironmental Analysis of Geothermal Power Plant (proposed in Castelnuovo; 2019)

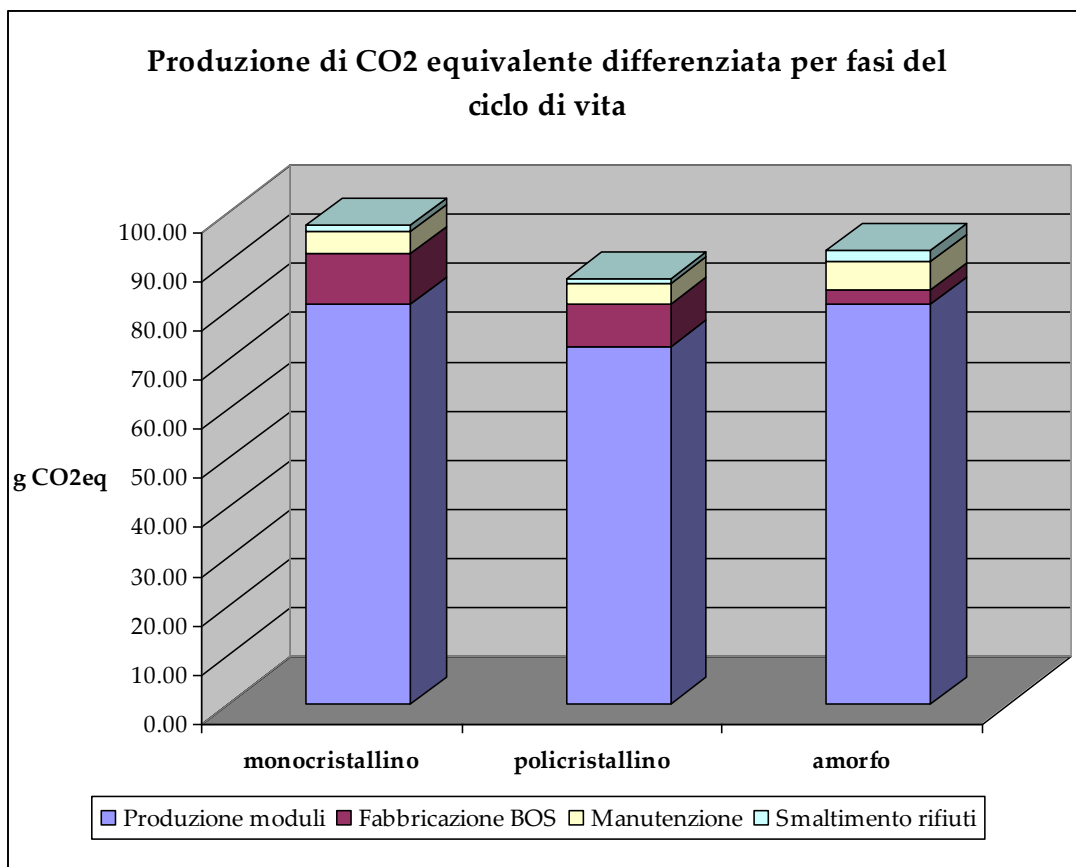
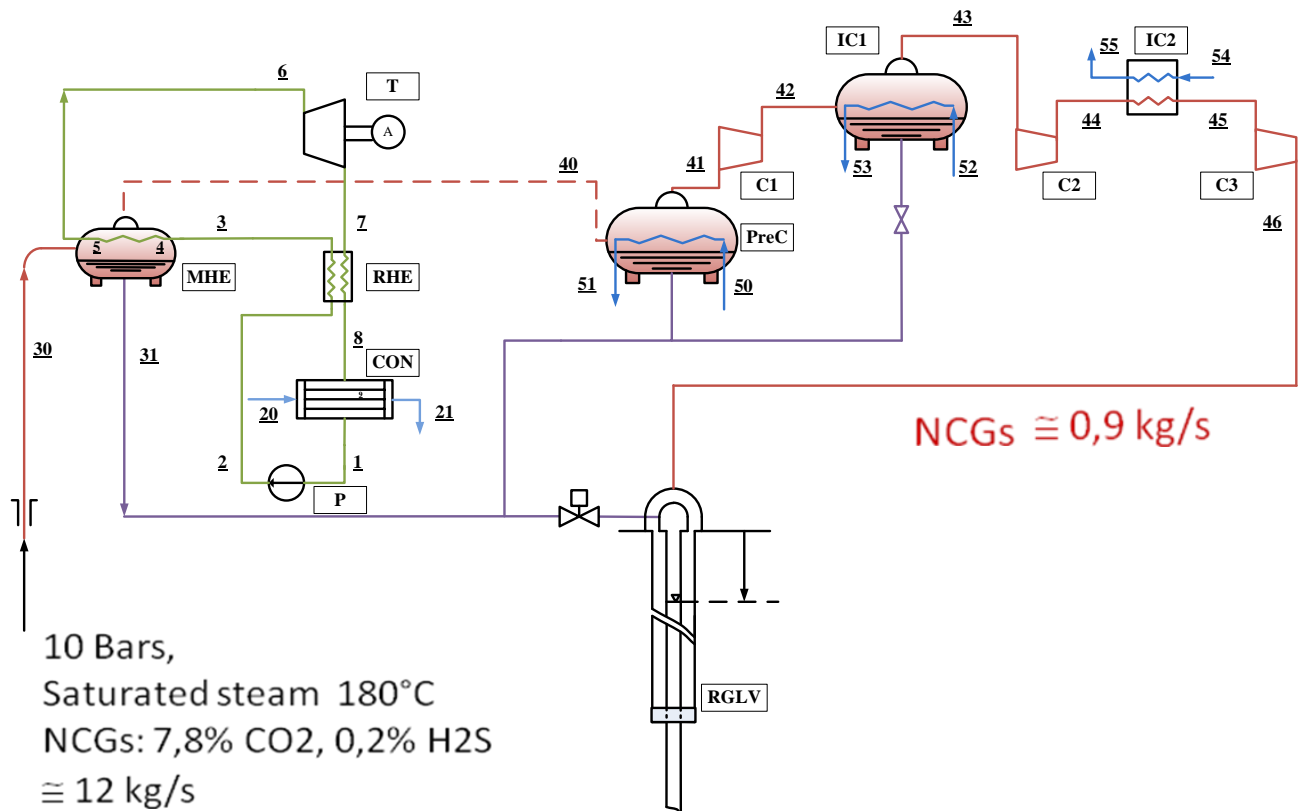

Figure A6.1 – Castelnuovo Power Plant Layout (including recompression and reinjection process)

The ORC cycle (R1234yf) includes complete reinjection of Non-Condensable Gases (NCGs = CO<sub>2</sub> + H<sub>2</sub>S) through a two-phase reinjection layout (HECO H2020 Project).

The Exergy Balance leads to evaluate  $\eta_x = 0,18$ , with the most relevant exergy destructions and losses taking place in the power cycle; the EXDLs of the reinjection train are small.

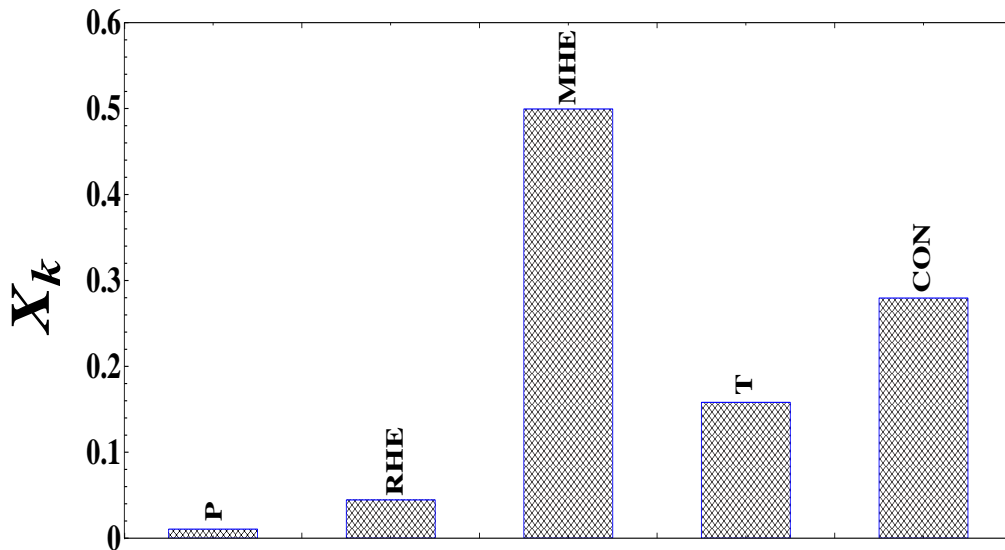

Figure A6.2 – Castelnuovo Power Plant Exergy Balance (Power cycle)

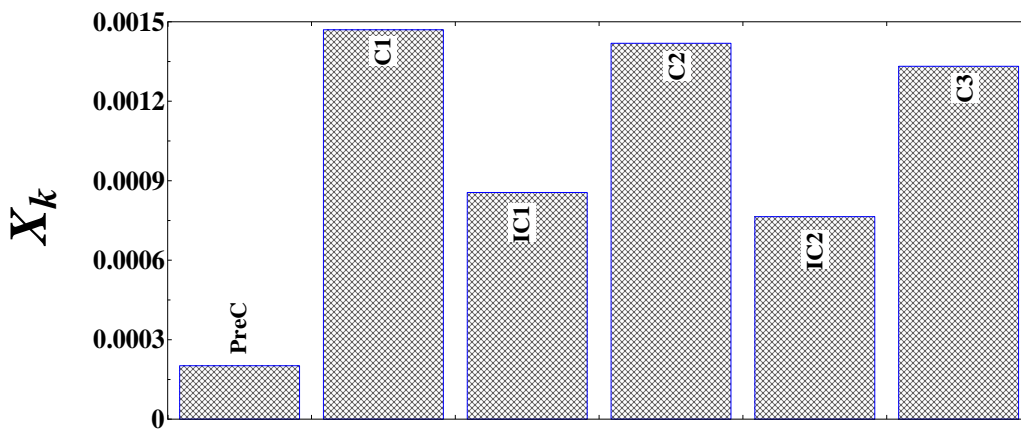

Figure A6.3 – Castelnuovo Power Plant Exergy Balance (Recompression)

The plant will be fed by 2 Production wells, and will use 1 Reinjection Well with two-phase technology (using Reversed Gas Lift valves). For the wells, the following cost correlation was adopted:

$$Well\ cost = n_{wells} * 2.5 * 1000 * D$$

Table A6.1 resumes the ExergoEconomic cost balances:

k	Component	Cost balance equations	Auxiliary equations
1	P	$c_2 \dot{E}x_2 = c_1 \dot{E}x_1 + c_{W_p} \dot{W}_p + \dot{Z}_p$	$c_{W_p} = c_{W_t}$
2	RHE	$c_3 \dot{E}x_3 + c_8 \dot{E}x_8 = c_2 \dot{E}x_2 + c_7 \dot{E}x_7 + \dot{Z}_{HE}$	$c_7 = c_8$
3	MHE	$c_6 \dot{E}x_6 + c_{31} \dot{E}x_{31} + c_{40} \dot{E}x_{40} = c_3 \dot{E}x_3 + c_{30} \dot{E}x_{30} + \dot{Z}_{HEGeo}$	$c_{30} = c_{31}$ $c_{40} = c_{30}$
4	T	$c_7 \dot{E}x_7 + c_{W_t} \dot{W}_t = c_6 \dot{E}x_6 + \dot{Z}_t$	$c_6 = c_7$
5	CON	$c_1 \dot{E}x_1 + c_{21} \dot{E}x_{21} = c_8 \dot{E}x_8 + c_{20} \dot{E}x_{20} + \dot{Z}_{cond}$	$c_{20} = 0$ $c_{21} = c_{20}$
6	PreC	$c_{41} \dot{E}x_{41} + c_{51} \dot{E}x_{51} = c_{40} \dot{E}x_{40} + c_{50} \dot{E}x_{50} + \dot{Z}_{PC1}$	$c_{50} = 0$ $c_{40} = c_{41}$
7	C1	$c_{42} \dot{E}x_{42} = c_{41} \dot{E}x_{41} + c_{W_{c1}} \dot{W}_{c1} + \dot{Z}_{c1}$	$c_{W_{c1}} = c_{W_t}$
8	IC1	$c_{43} \dot{E}x_{43} + c_{53} \dot{E}x_{53} = c_{42} \dot{E}x_{42} + c_{52} \dot{E}x_{52} + \dot{Z}_{IC1}$	$c_{52} = c_{50}$ $c_{43} = c_{42}$
9	C2	$c_{44} \dot{E}x_{44} = c_{43} \dot{E}x_{43} + c_{W_{c2}} \dot{W}_{c2} + \dot{Z}_{c2}$	$c_{W_{c2}} = c_{W_t}$
10	IC2	$c_{45} \dot{E}x_{45} + c_{55} \dot{E}x_{55} = c_{44} \dot{E}x_{44} + c_{54} \dot{E}x_{54} + \dot{Z}_{IC2}$	$c_{54} = c_{50}$ $c_{45} = c_{44}$
11	C3	$c_{46} \dot{E}x_{46} = c_{45} \dot{E}x_{45} + c_{W_{c3}} \dot{W}_{c3} + \dot{Z}_{c3}$	$c_{W_{c3}} = c_{W_t}$

Table A6.1 – ExergoEconomic Cost Balance Equations

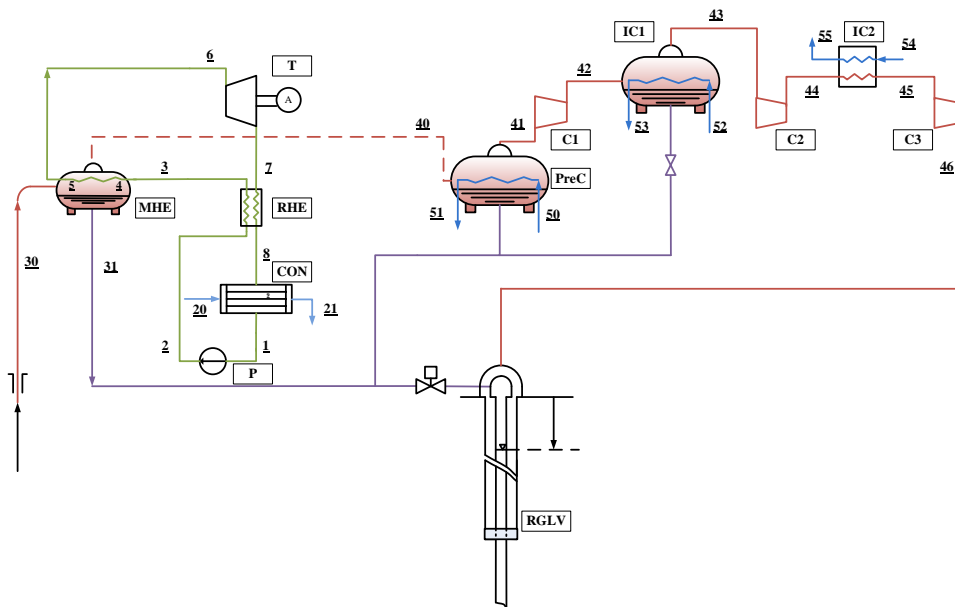

Table A6.2 resumes the results of the ExergoEconomic Analysis.

Component	PEC (€)	$\dot{Z}_k$ (€/s)	$\dot{C}_{D,k}$ (€/s)	$\dot{Z}_k + \dot{C}_{D,k}$ (€/s)	$c_{F,k}$ (€/kWh)	$c_{P,k}$ (€/kWh)	$f_k$ (%)
P	193464	0.001558	0.0008032	0.002361	0.07148	0.1056	65.99
RHE	438204	0.00353	0.00242	0.00595	0.05154	0.1009	59.32
MHE	2.920E+06	0.02352	0.009514	0.03303	0.01804	0.03419	71.2
T	2.651E+06	0.02136	0.008596	0.02995	0.05154	0.07148	71.3
CON	656282	0.005286	0.01634	0.02162	0.05538	0.2662	19.36
PreC	181662	0.001463	0.000003835	0.001467	0.01804	1.819	99.74
C1	126231	0.001017	0.0001109	0.001128	0.07148	0.1835	90.16
IC1	185022	0.00149	0.000053	0.001543	0.05869	0.8226	96.57
C2	120236	0.0009685	0.0001071	0.001076	0.07148	0.1837	90.05
IC2	219831	0.001771	0.00006767	0.001838	0.08384	1.008	96.32
C3	113008	0.0009102	0.0001005	0.001011	0.07148	0.1834	90.06

Table A6.2 – Results of the ExergoEconomic Analysis

The most cost-intensive components are the Main Heat exchanger MHE and the Turbine T (which have both a high Capital Cost  $Z$  and Exergy Destruction Cost). Pump, RHE, MHE and T would benefit from a larger capital investment (components with low  $f_k$ ).

The Levelized Cost of Electricity is attractive ( $c_{P,T} = 0,071$  €/kWh - the present level of incentives for clean geothermal power is 0,12 €/kWh).

The high Capital Cost of the wells determines the cost of the inlet stream (fuel) to the MHE ( $c_{30} = 0,018$  €/kWh).

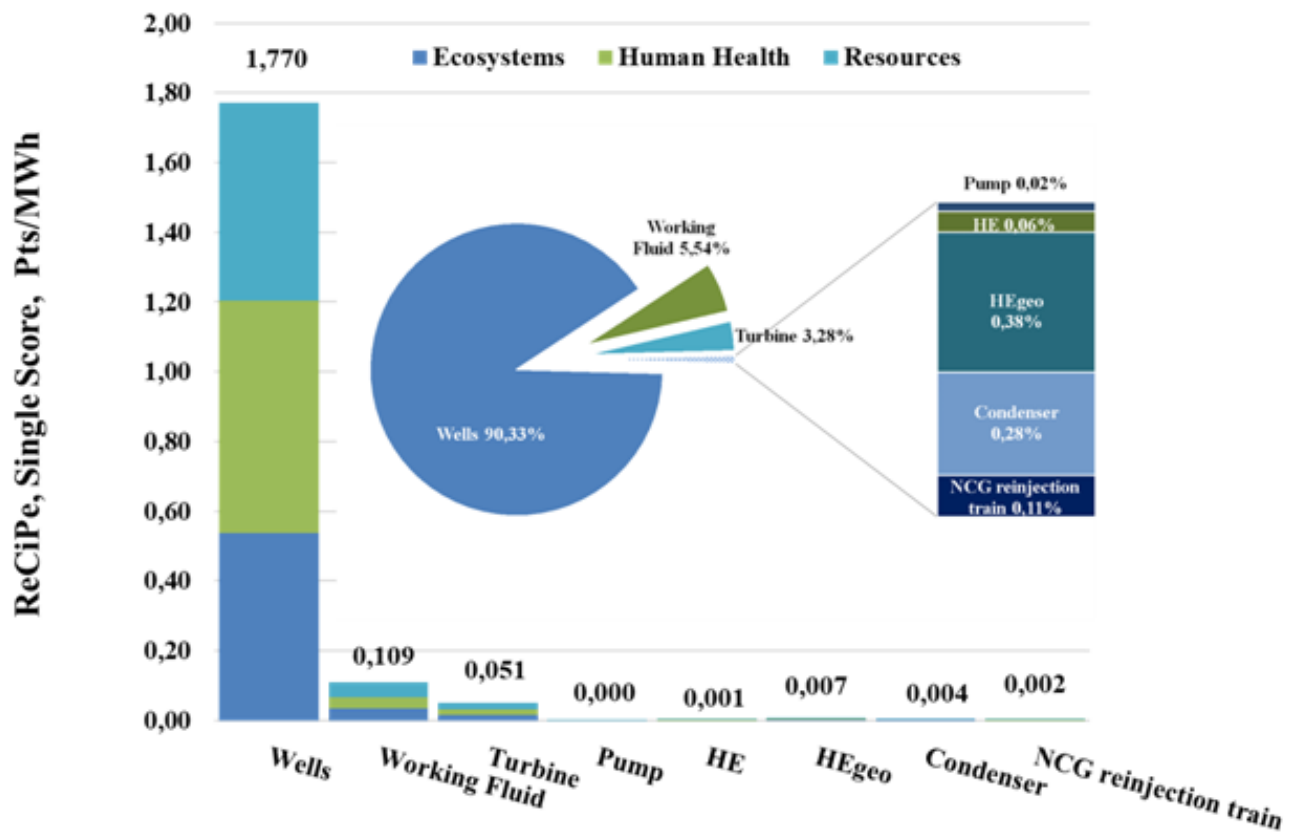

Table A6.3 collects the LCI of the Castelnuovo power plant.

Equipment/material	machinery	Quantity	Units	Ecoinvent record
<b>Piping ORC - wells</b>		1	m	Total length: 390 m
Steel		6,767	kg	market for steel, low-alloyed, alloc. default, U - GLO
INOX 316 L		0,556	kg	market for steel, chromium steel 18/8, alloc. default, U - GLO
Mineral wool		2,577	kg	market for rock wool, alloc. default, U - GLO
<b>Turbine</b>		5409	kW	
Reinforcing Steel		56176	kg	reinforcing steel production, alloc. default, U
Steel, low-alloyed		92530	kg	market for steel, low-alloyed, hot rolled, alloc. default, U
Chromium steel 18/8		2017	kg	market for steel, chromium steel 18/8, alloc. default, U
Copper		5452	kg	market for copper, primary production, alloc. default, U
Aluminum		3094	kg	market for aluminium, wrought alloy, alloc. default, U - GLO
Iron-nickel-chromium alloy		1644	kg	market for cast iron, alloc. default, U
Polyethylene, HDPE		1364	kg	polyethylene production, low density, granulate, alloc. default, U
<b>Air cooled condenser</b>		21775	kW	
Steel low-alloyed			kg	market for steel, low-alloyed, hot rolled, alloc. default, U
Chromium steel 18/8			kg	market for steel, chromium steel 18/8, alloc. default, U
Aluminum			kg	market for aluminium, wrought alloy, alloc. default, U - GLO
Polyethylene HDPE			kg	polyethylene production, low density, granulate, alloc. default, U
<b>Economizer + Evaporator</b>		26894	kW	
Copper tube		5353	kg	market for copper, primary production, alloc. default, U
Cast iron		611	kg	market for cast iron, alloc. default, U
Steel		86	kg	market for steel, low-alloyed, hot rolled, alloc. default, U
<b>Pump</b>		290	kW	
Stainless steel		319	kg	market for steel, chromium steel 18/8, alloc. default, U
Copper		106	kg	market for copper, primary production, alloc. default, U
<b>Recuperator</b>		4044	kW	
Copper tube		805	kg	market for copper, primary production, alloc. default, U
Cast iron		92	kg	market for cast iron, alloc. default, U
Steel		13	kg	market for steel, low-alloyed, hot rolled, alloc. default, U
<b>Compressors</b>		41.8/39.9/37.6	kW	
Steel		164/159/159	kg	market for steel, low-alloyed, hot rolled, alloc. default, U
Cast iron		123/119/119	kg	market for cast iron, alloc. default, U
Copper wire		82/79/79	kg	market for wire drawing, copper, alloc. default, U - GLO
Aluminum		57/56/56	kg	market for aluminium, wrought alloy, alloc. default, U - GLO
<b>Precooler/Intercoolers</b>		1.3/4.7/4.6	m <sup>2</sup>	
Stainless steel		368.8/100.7/374.8	kg	market for steel, chromium steel 18/8, alloc. default, U
<b>Working fluid</b>		30 831	kg	- (Ding <i>et al.</i> , 2018).
R1233zd				

Table A6.3 – Life Cycle Inventory of the Castelnuovo Geothermal Power Plant

Figure A6.4 summarizes the results of the LCA.



The overall score of **1,95 EcoPoints/MWh** is very attractive with respect to other renewable such as PV (which today – 2019 – score 10-25 EcoPoints/MWh). This positive result is due to operation of the plant with a limited number of wells (2 PW + 1 RW) and to the good properties of the resource (saturated steam at 10 bar, 180°C), which allow a good efficiency and operation with a limited flow rate of geothermal resource fluid. Other plants (always ORC without NCG emission to the environment), operating on liquid geothermal resource at lower temperature (Torre Alfina) require operation on 5 PWs + 3RWs and achieve an EcoPoint score of **about 13 EcoPoints/MWh**. Even for Castelnuovo, the largest part of the EcoPoints are due to the drilling of the wells (1,77 EP/kWh).

Based on the LCI, disaggregated among plant components, an ExergoEnvironmental analysis was performed. The results are shown in Table A6.4.

Component	$\dot{Y}_k$ (Pts/h)	$\dot{B}_{D,k}$ (Pts/h)	$\dot{B}_{D,k} + \dot{Y}_k$ (Pts/h)	$f_{D,k}$ (%)	$r_{D,k}$ (%)
P	0.00313	0.02277	0.0259	12.09	18.46
RHE	0.004243	0.02158	0.02582	16.43	32.02
MHE	0.1143	0.4946	0.6089	18.77	33.19
T	0.135	0.2834	0.4183	32.26	17.47
CON	0.06413	0.4939	0.558	11.49	-
PreC	0.0002291	0.0001925	0.0004216	54.33	57.13
C1	0.0006466	0.002882	0.003529	18.32	18.88
IC1	0.000871	0.001107	0.001978	44.04	79.87
C2	0.0006277	0.002782	0.00341	18.41	19.16
IC2	0.0008416	0.00115	0.001991	42.27	70.31
C3	0.0006103	0.002611	0.003222	18.94	19.21

Table A6.4 - Results of the ExergoEnvironmental Analysis – Castelnuovo Geothermal Power Plant

The ExergoEnvironmental Analysis confirms that the MHE and the Turbine are the most intensive components also from the point of view of the environmental cost, both in terms of construction and exergy destruction (performance); however, from an environmental point of view it would be worth to improve these components, because the exergy destruction term is dominant (as is shown by the low values of  $f_{d,k}$ ). The same is true for all components of the power cycle (but pump and RHE are responsible of the destruction of a limited amount of Points/h). The Compressors (C1, C2, C3) of the reinjection train have a high value of environmental cost increase across the components  $r_{d,k}$ ; however, they are responsible of a few mPoints/h in terms of environmental issues, so that their improvement is not specifically attractive.

The following is a very recent (2019) LCA comparison of Geothermal (Flash - traditional), Wind and Photovoltaic energy conversion processes for a reference peak size of 20 MWe.

(Recipe MidPoint (EcolInvent 2012 (H))). Work performed by a training student, ENEL-GP.

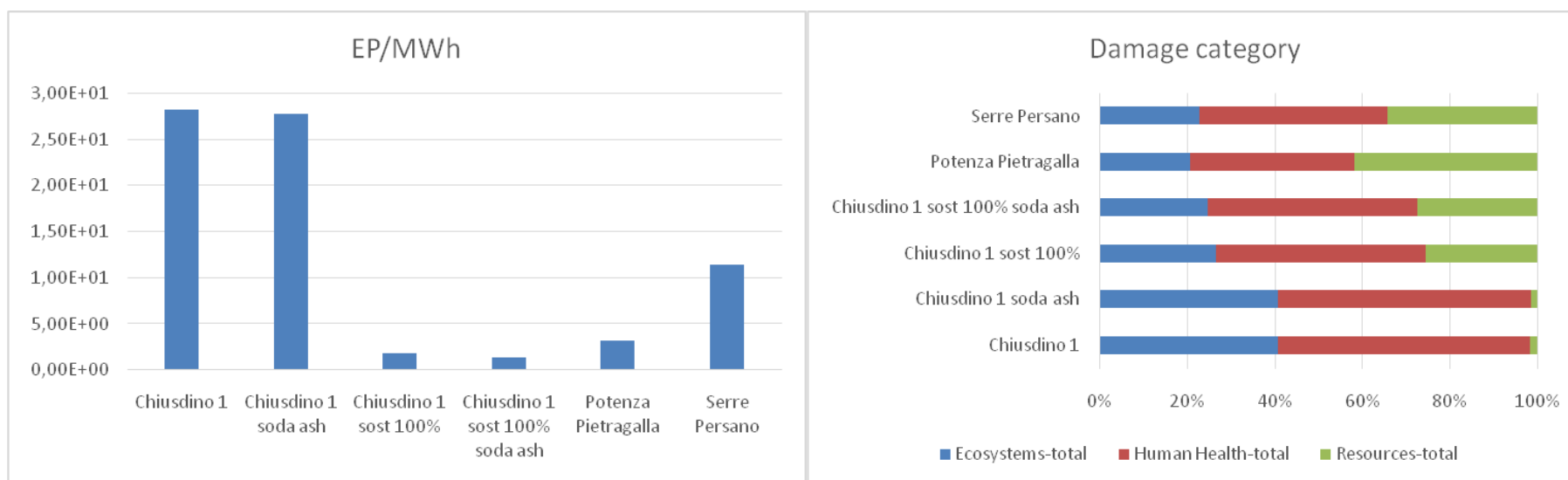

## Non-Exhaustive list of Reference and useful web sites for LCA

- 1) Baldo, G. L., "LCA LIFE CYCLE ASSESSMENT : Uno strumento di analisi energetica e ambientale", Iperservizi Editore
- 2) Goedkoop, M., Demmers, M., and Collignon, M., "The Eco-Indicator 95 Manual for Designers". (Pré Consultants).
- 3) LCA training package, CASCADE, Chalmers University of Technology, 2003
- 4) Emmerson, R.H.C., et al., The Life-Cycle Analysis of Small-Scale Sewage-Treatment Process J.CIWEM, 9 June.1995
- 5) Szargut, J., 1987, Analysis of Cumulative Exergy Consumption, Int. J. of Energy Research, 11, pp. 541-547
- 6) Szargut, J., Morris, D.R., Steward, F.R., Exergy Analysis of Thermal, Chemical, and Metallurgical Processes, 1988, Hemisphere Publishing Corporation (USA)
- 7) Spath, P.L., Mann, M.K., "Life Cycle Assessment of Hydrogen Production via Natural Gas Reforming", NREL/TP-570-27637
- 8) Fiaschi, D. Lombardi, L., Manfrida, G., "Life Cycle Assessment (LCA) And Exergetic Life Cycle Assessment (ELCA) of an Innovative Energy Cycle With Zero CO<sub>2</sub> Emissions", GHGT-5, "5<sup>th</sup> International Conference on Greenhouse Gas Control Technologies", Cairns, 2000
- 9) Cornelissen, R. L., "Thermodynamics and Sustainable Development", PhD Thesis, Un. of Twente, 1997
- 10) <http://www.lcacenter.org/library/pdf/PSME2002a.pdf>
- 11) [www.enea.it](http://www.enea.it)
- 12) <http://www.quality.it/lca.html>
- 13) <http://digilander.libero.it/giabon>
- 14) <http://www.reteambiente.it/ra/sostenibilita/catalogo/8105sl.htm>
- 15) <http://www.expr.it/lca.asp>
- 16) [http://en.wikipedia.org/wiki/Sustainable\\_development](http://en.wikipedia.org/wiki/Sustainable_development)