

Neuroeconomia

La **neuroeconomia** o **neuroscienze della decisione** studia il funzionamento della mente umana in relazione ai processi decisionali nella soluzione di compiti economici. E' decisamente interdisciplinare (psicologia, economia, medicina, matematica, neurologia etc..) .

L'obiettivo della neuroeconomia è quello di incrociare il corpus di conoscenze della sfera economica con quelle provenienti da ambiti psicologici e scientifici per determinare come si comporta il cervello durante i processi di decision making.

Il presupposto da cui parte l'analisi neuroeconomica è che – a differenza di quanto affermato dall'economia tradizionale - *l'uomo non è un animale razionale*, bensì agisce sotto l'impulso di processi neuronali automatici e molto spesso inconsci, quindi indipendenti dalla propria volontà. Ciò fa sì che il comportamento economico umano sia dovuto ad un'integrazione di segnali nervosi consci ed inconsci alla base della razionalità e della emotività.

Ipotesi del marcatore somatico (Bechara et al 2000)

The somatic marker hypothesis provides a systems-level neuro-anatomical and cognitive framework for decision making and the influence on it by emotion.

The key idea of this hypothesis is that **decision making is a process that is influenced by marker signals that arise in bioregulatory processes**, including those that express themselves in emotions and feelings.

This influence can occur at multiple levels of operation, some of which occur consciously and some of which occur non-consciously.

The **orbitofrontal cortex** represents one critical structure in a neural system subserving decision making. Decision making is not mediated by the orbitofrontal cortex alone, but arises from large-scale systems that include other cortical and subcortical components.

Such structures include the **amygdala**, the **somatosensory/insular cortices** and the **peripheral nervous system**

Ipotesi del marcatore somatico (Bechara et al 2000)

The somatic marker hypothesis is based on the following main assumptions:

1. human reasoning and decision making **depend on many levels of neural operation**, some of which are conscious and overtly cognitive (depend on sensory images based on the activity of early sensory cortices) some of which are not;
2. cognitive operations, regardless of their content, depend on support processes such as **attention, working memory** and **emotion**;
3. reasoning and decision making depend on the **availability of knowledge** about situations, actors, options for action and outcomes; such knowledge is stored in 'dispositional' form throughout higher-order cortices and some subcortical nuclei (the term dispositional is synonymous with **implicit and non-topographically organized**); dispositional knowledge can be made explicit in the form of (a) motor responses of varied types and complexity (some combinations of which are part of emotions) and (b) images.
4. knowledge can be classified as follows: (a) innate and acquired knowledge concerning bioregulatory processes and body states and actions, including those which are made explicit as emotions; (b) knowledge about entities, facts (e.g. relations, rules), actions and action-complexes (stories), which are usually made explicit as images; (c) knowledge about the linkages between (b) and (a) items, as reflected in individual experience; and (d) knowledge resulting from the categorizations of items in (a), (b) and (c).

Ruolo della corteccia prefrontale ventromediale

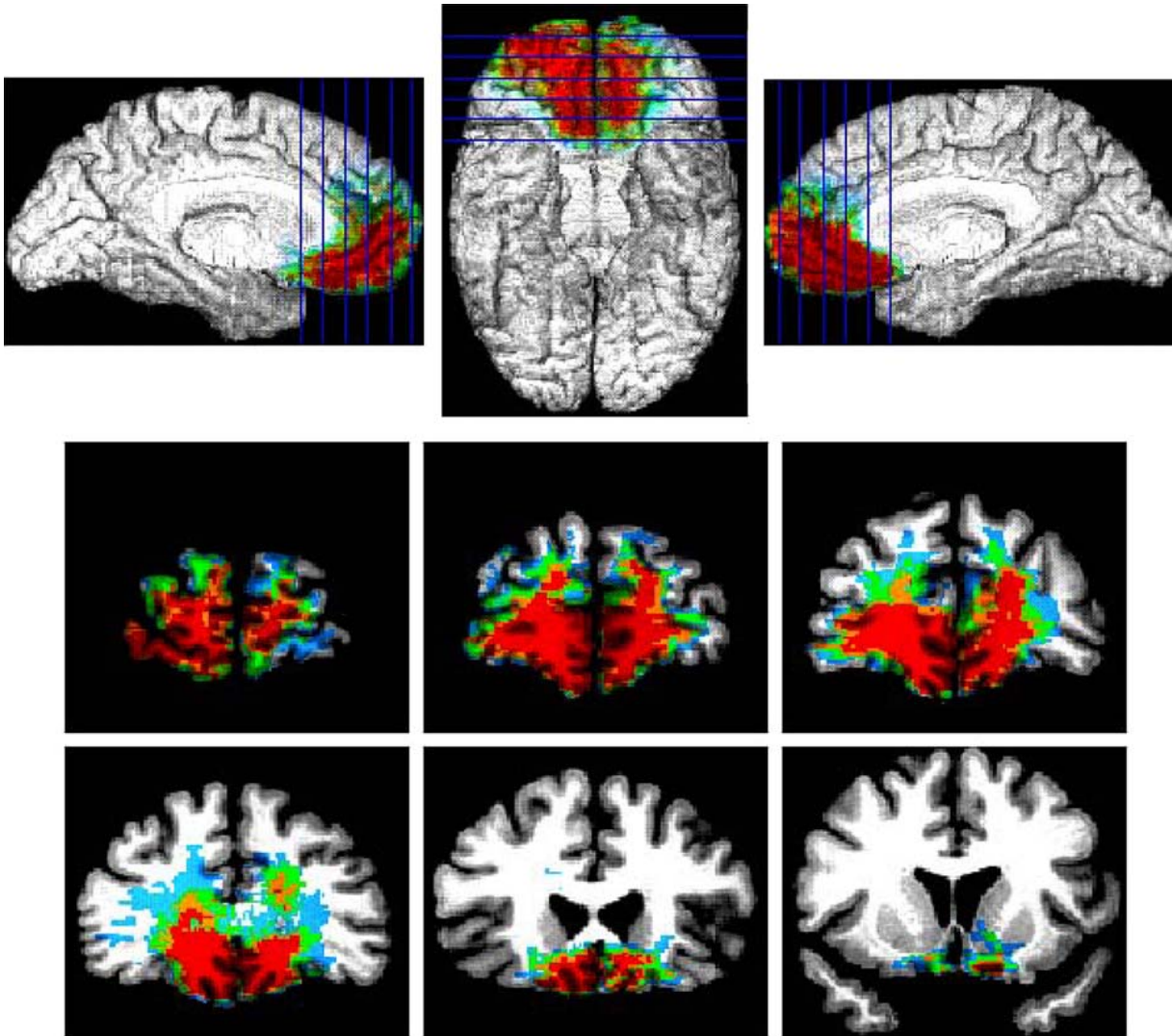

Gambling task
(Bechara et al 1994)

Fig. 1. Overlap of lesions in a group of VM patients. The red color indicates an overlap of four or more patients. From (Bechara, Damasio, & Damasio, 2000) (For interpretation of the references to color in this figure legend, the reader is referred to the web version of this paper.).

Ruolo della corteccia prefrontale ventromediale

Gambling task (Bechara et al 1994)

Comportamento

The task involves four decks of cards, named A, B, C and D. The goal is to maximize profit on a loan of play money. Subjects are required to make a series of 100 card selections, but are not told ahead of time how many card selections they are going to be allowed to make. Cards can be selected one at a time, from any deck, and subjects are free to switch from any deck to another, at any time and as often as they wish. The decision to select from one deck or another is largely influenced by schedules of reward and punishment. These schedules are pre-programmed and known to the examiner, but not to the subject (Bechara et al., 1994, 1999a). They are arranged in such a way that every time the subject selects a card from deck A or B, s/he gets \$100, and every time deck C or D is selected, the subject gets \$50. However, in each of the four decks, subjects encounter unpredictable money loss (punishment). The punishment is set to be higher in the high-paying decks A and B, and lower in the low-paying decks C and D. In decks A and B the subject encounters a total loss of \$1250 in every 10 cards. In decks C and D the subject encounters a total loss of \$250 in every 10 cards. In the long term, decks A and B are disadvantageous because they cost more, a loss of \$250 in every 10 cards. Decks C and D are advantageous because they result in an overall gain in the end, a gain of \$250 in every 10 cards.

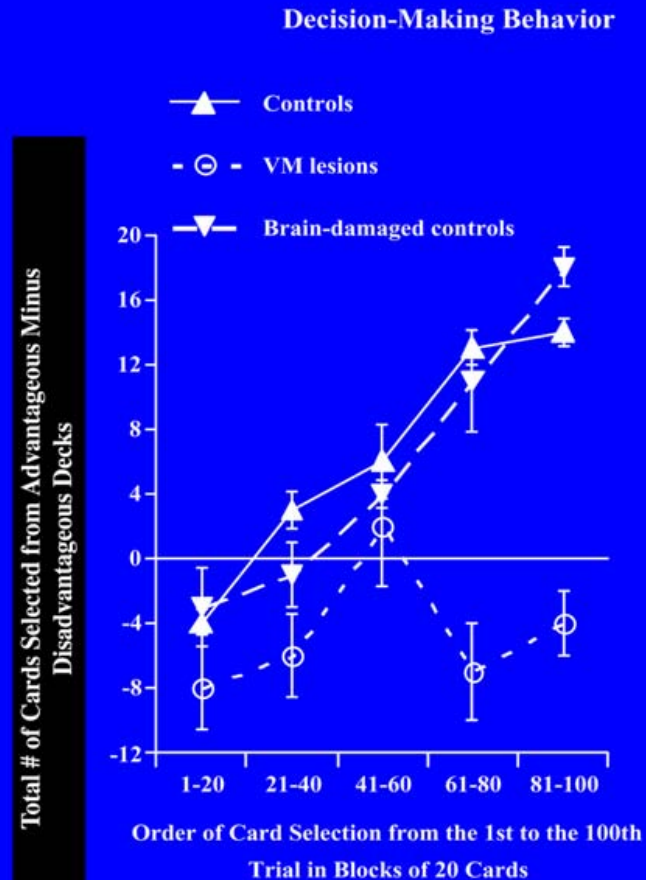

Fig. 2. Relative to normal controls and brain-damaged controls, VM patients were impaired in their performance on the gambling task. The figure shows net scores $((C + D) - (A + B))$ of cards selected by each group across different blocks expressed as means \pm SEM. Positive net scores reflect advantageous performance while negative net scores reflect disadvantageous performance.

Ruolo della corteccia prefrontale ventromediale

Misura della conduttanza

Gambling task (Bechara et al 1994)

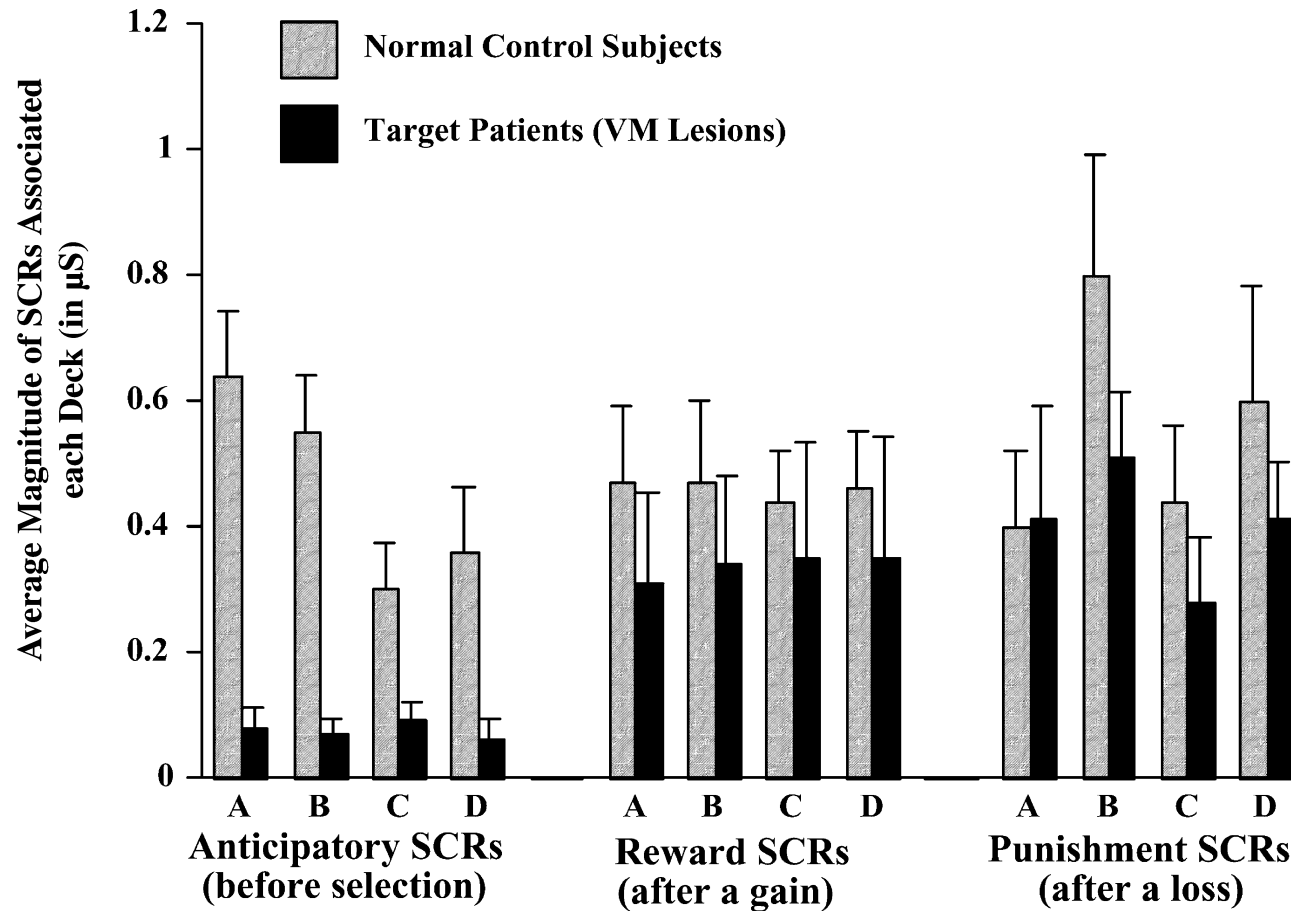

Fig. 3. Means \pm SEM of the magnitudes of anticipatory, reward, and punishment SCRs generated by normal controls and target patients (VM lesions) averaged across all cards selected from a given deck.

Ruolo della corteccia prefrontale ventromediale

Gambling task (Bechara et al 1994)

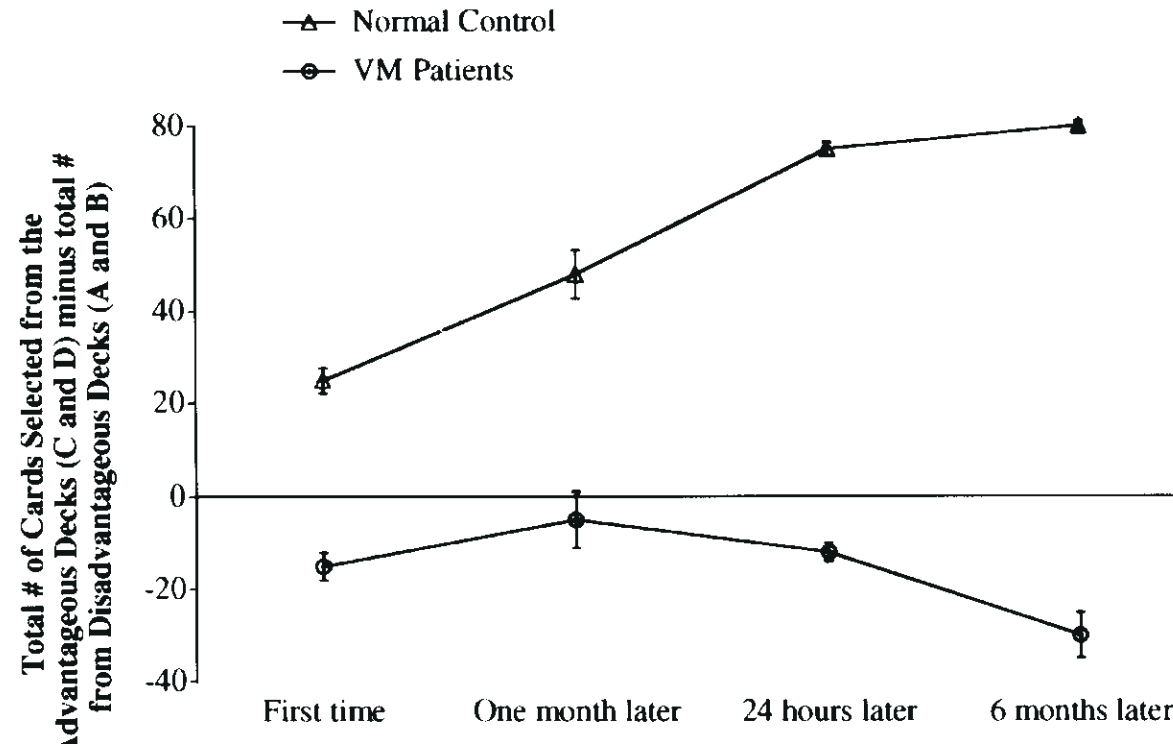

Figure 3. A learning curve revealing the level of performance of normal control ($n = 5$) and VM patients ($n = 6$) on the gambling task, as a function of repetition over time. The VM patients failed to show a significant improvement as a function of repeated testing.

Ruolo della corteccia prefrontale ventromediale

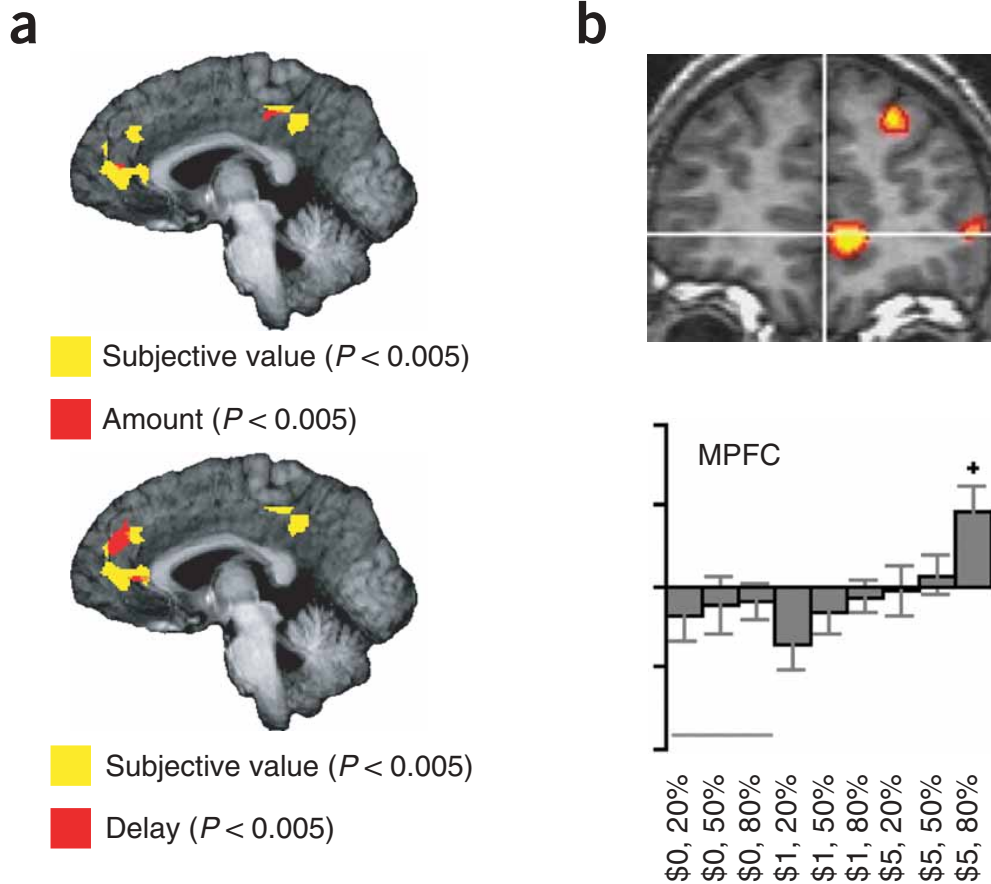

Figure 6 VMPFC activation and representation of subjective value. **(a)** Human subjects made decisions about whether to opt for delayed monetary rewards of various amounts at various delays or for a standard payment of US\$20 that would be made immediately. The rates at which the values of delayed rewards were discounted by subjects were calculated from each individual's choice data. The resulting estimates of the subjective values of choice options were then regressed against the fMRI-recorded brain activity. Activity in the VMPFC and adjacent ACC and in the posterior cingulate cortex was better correlated with (top) the subjective values of the choice options (yellow) than with the objective amount of monetary reward (red) or with (bottom) the objective delay to the monetary reward (red). Reprinted with permission from Kable and Glimcher⁷² (*Nature Neuroscience*). **(b)** Subjects were shown stimuli that predicted different reward magnitudes with different probabilities. VMPFC activity (top, crosshairs) increased linearly both with increasing reward probability and with increasing reward magnitude (bottom; error bars, s.e.m.). Activity therefore encoded the expected value of the stimulus. Reprinted with permission from Knutson *et al.*⁷⁰ (*Journal of Neuroscience*).

Ruolo della corteccia cingolata anteriore

- Reinforcement learning models that focus on the striatum and dopamine can predict the choices of animals and people.
- Representations of reward expectation and of reward prediction errors that are pertinent to decision making, however, are not confined to these regions but are also found in prefrontal and cingulate cortex.
- Moreover, **decisions are not guided solely by the magnitude of the reward that is expected.** Uncertainty in the estimate of the reward expectation, the value of information that might be gained by taking a course of action and the cost of an action all influence the manner in which decisions are made through prefrontal and cingulate cortex.

Ruolo della corteccia cingolata anteriore

Durante decisioni in cui si valutano rischi si ha attivazione della corteccia cingolata (prefrontale) nelle scimmie: in generale attivazione maggiore per le perdite che per i guadagni.

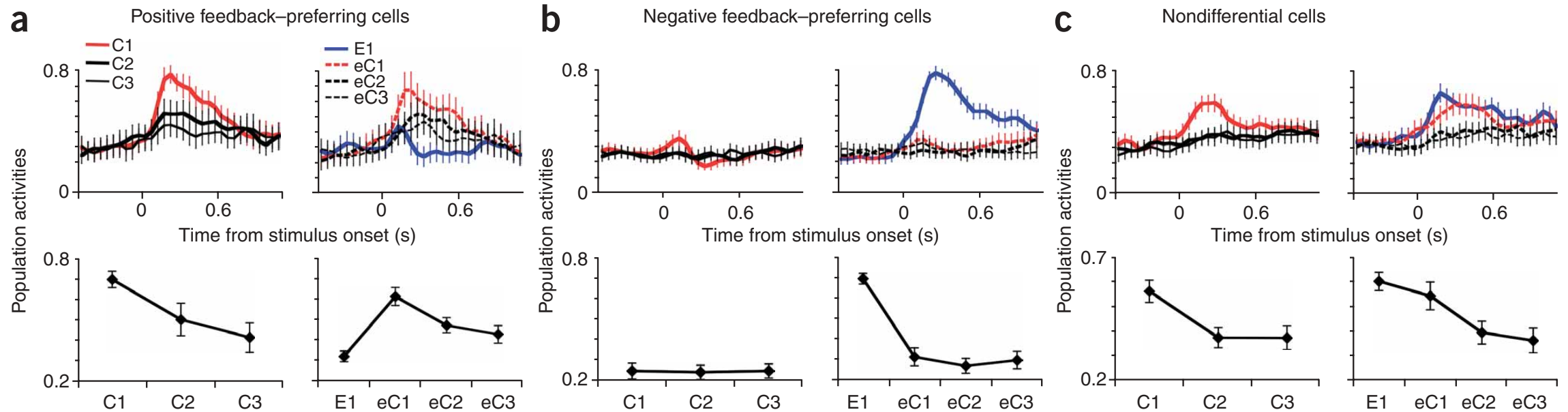
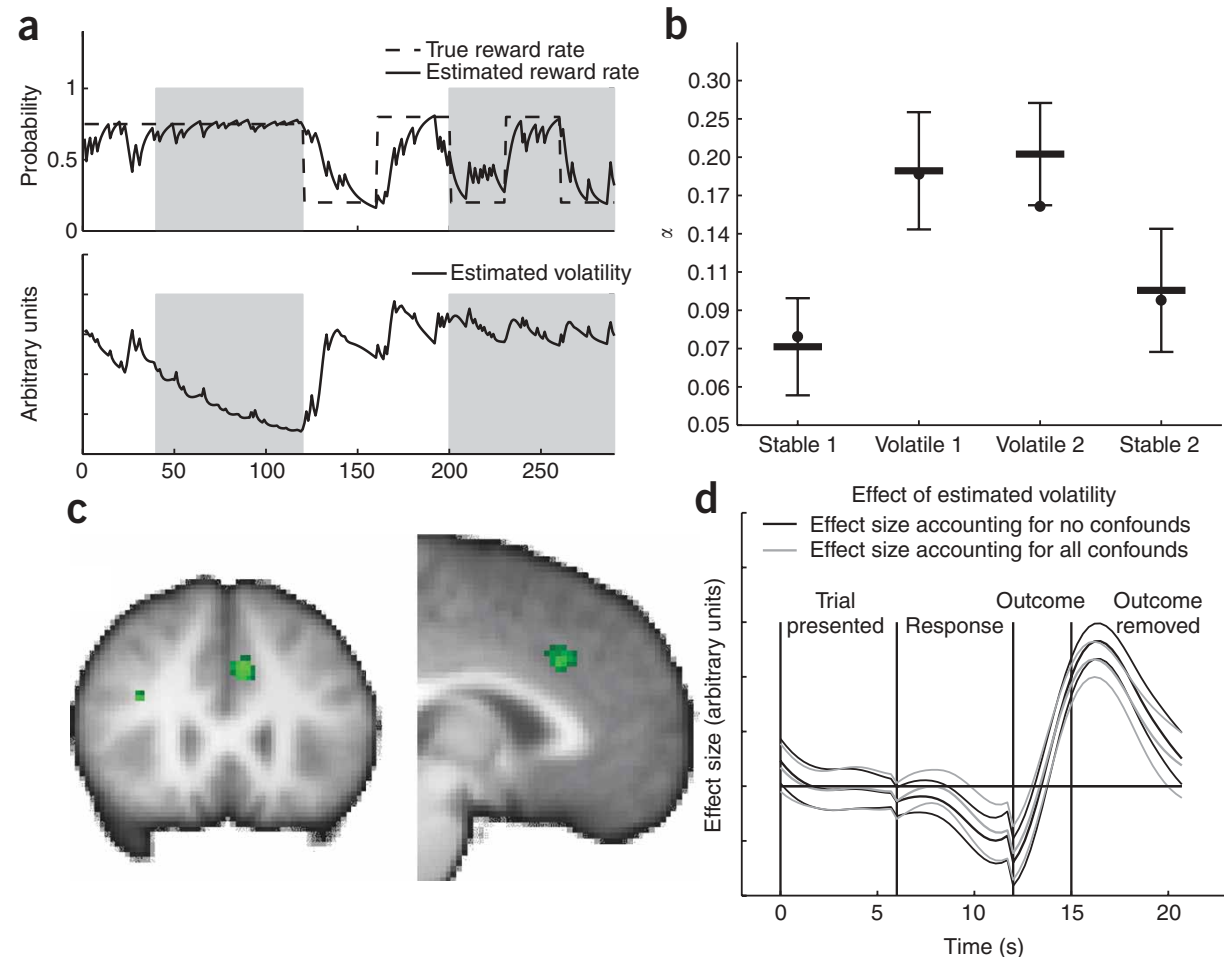

Figure 2 Prediction error encoding in the ACC. Changes of activity in a population of medial frontal cortical neurons centered on the ACC sulcus during the course of learning which action was rewarded with a secondary reinforcer. (a–c) Averaged responses of 16 positive feedback-preferring cells (a), 32 negative feedback-preferring cells (b) and 34 nondifferential cells (c). Bin width in upper graphs in each section, 50 ms. The activity of each cell was normalized by its peak activity and then averaged across cells. Each graph shows activity across three trials of a typical problem set. On the first trial, monkeys did not know which was the correct action to choose. On half of trials (left column, C1) the monkeys guessed correctly and chose the action associated with a positive secondary reinforcer. Usually the monkeys continued to choose correctly on the subsequent trials (C2 and C3) on these blocks. In the other half of blocks, the monkeys' first choices were incorrect (right column, E1). The monkeys usually corrected their choices on the subsequent three trials (eC1, eC2 and eC3). Positive feedback-preferring neurons and nondifferential neurons were active in relation to the positive prediction error when the first choice was made correctly but subsequently decreased their activity once the correct choice was known. Negative feedback-preferring neurons and nondifferential neurons were active in relation to the negative prediction error when the first choice was made incorrectly but subsequently decreased their activity once the correct choice was known. (Reprinted with permission from Matsumoto *et al.*²⁵ (*Nature Neuroscience*)).

Ruolo della corteccia cingolata anteriore

- L'attivazione e l'apprendimento della strategia riflettono una stima della statistica delle perdite/vincite, mostrando grande flessibilità

Figure 3 ACC, volatility and the learning rate. Learning rates are flexibly adapted to best suit environmental statistics, and this effect is mediated by the ACC. **(a)** Subjects underwent a decision making task in which the reward rate changed. Crucially, this changing reward rate went through periods of stability and periods of volatility (top panel). Optimal behavior requires that the subjects estimate this volatility (bottom panel) and adjust their learning rate accordingly. **(b)** Subject learning rates (α) during the stable and volatile phases of the experiment. Bars, mean \pm s.e.m. for human subjects. Dots, optimal learning rate. **(c)** A circumscribed region in the ACC correlates with the volatility estimate (or the related uncertainty). **(d)** Time course of the effect size in ACC. BOLD signal is related to the estimated volatility only when the outcome is observed. (Reprinted with permission from Behrens *et al.*⁵ (*Nature Neuroscience*)).



Ruolo della corteccia cingolata anteriore

Cingolotomia porta a rischio non si è più in grado di integrare le informazioni passate per il future =>inibizione di risposte impulsive ?

- Empirical integration curve from macaque monkeys when reward conditions are relatively volatile. The present decision (decision i) is influenced by only four trials into the past . (d) After a lesion to the ACC sulcus, macaques are no longer able to appropriately combine recent and historical information to guide behavior. Only the most recent trial guides the current decision

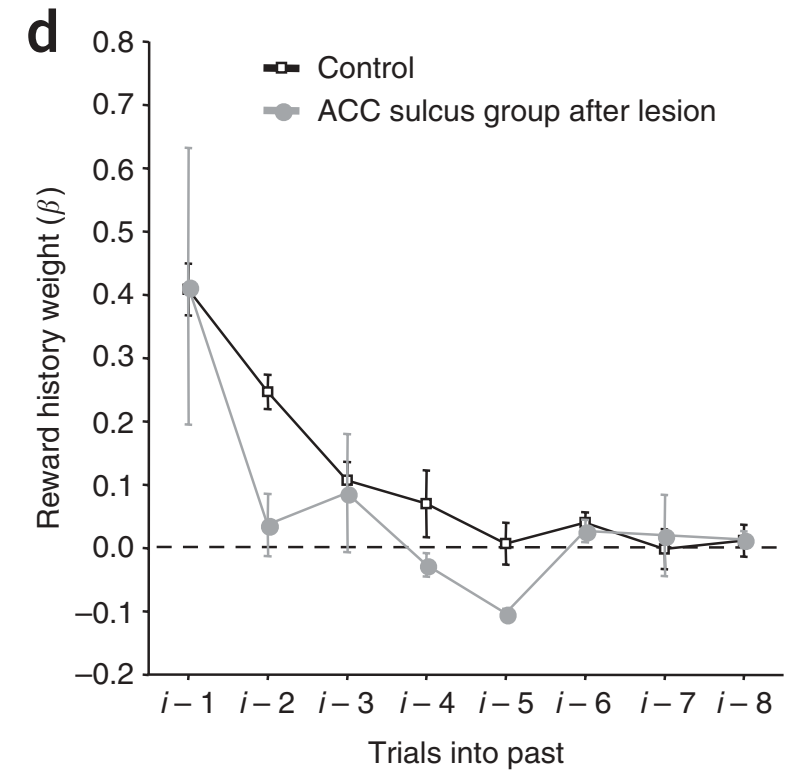
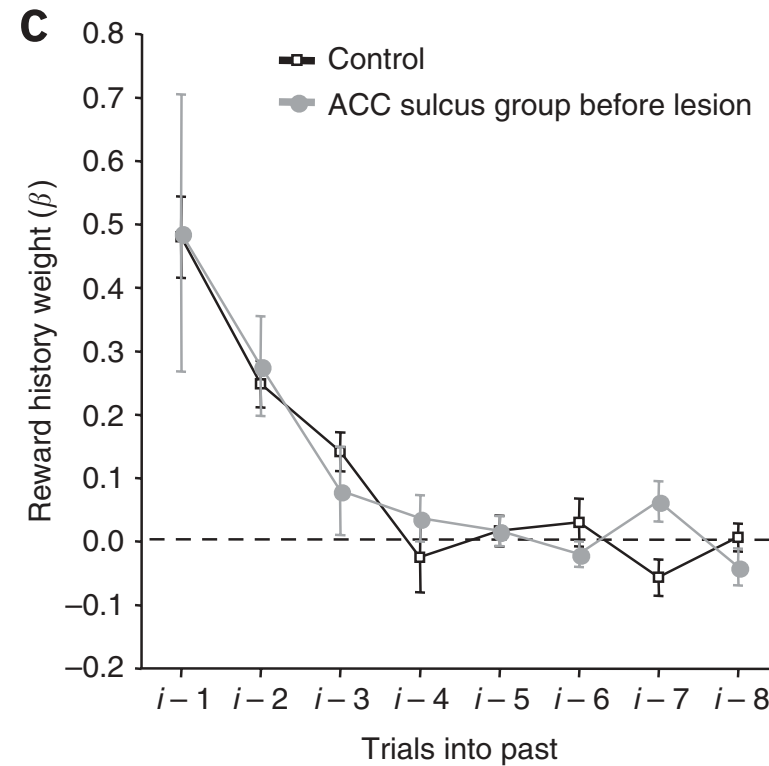

Ruolo della corteccia cingolata anteriore

The recently proposed *error-likelihood* hypothesis suggests that anterior cingulate cortex (ACC) and surrounding areas will become active in proportion to the **perceived likelihood of an error**. The ACC will be sensitive not only to perceived error likelihood, but also to the **predicted magnitude of the consequences**, should an error occur.

The product of error likelihood and predicted error consequence magnitude defines the general “expected risk” of a given. This suggests why some segments of the population may fail to show an error-likelihood effect. In particular, error-likelihood effects and expected risk effects in general indicate greater sensitivity to earlier predictors of errors and are seen in risk-averse but not risk-tolerant individuals.

ACC may generally contribute to cognitive control by recruiting brain activity to avoid risk.

Ruolo della corteccia cingolata anteriore

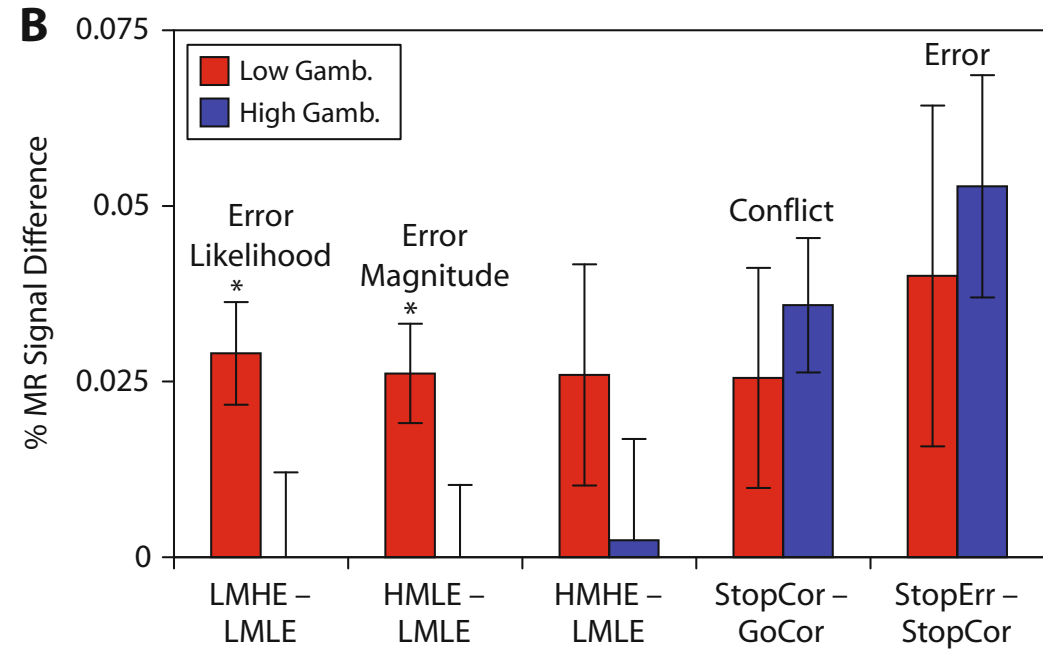
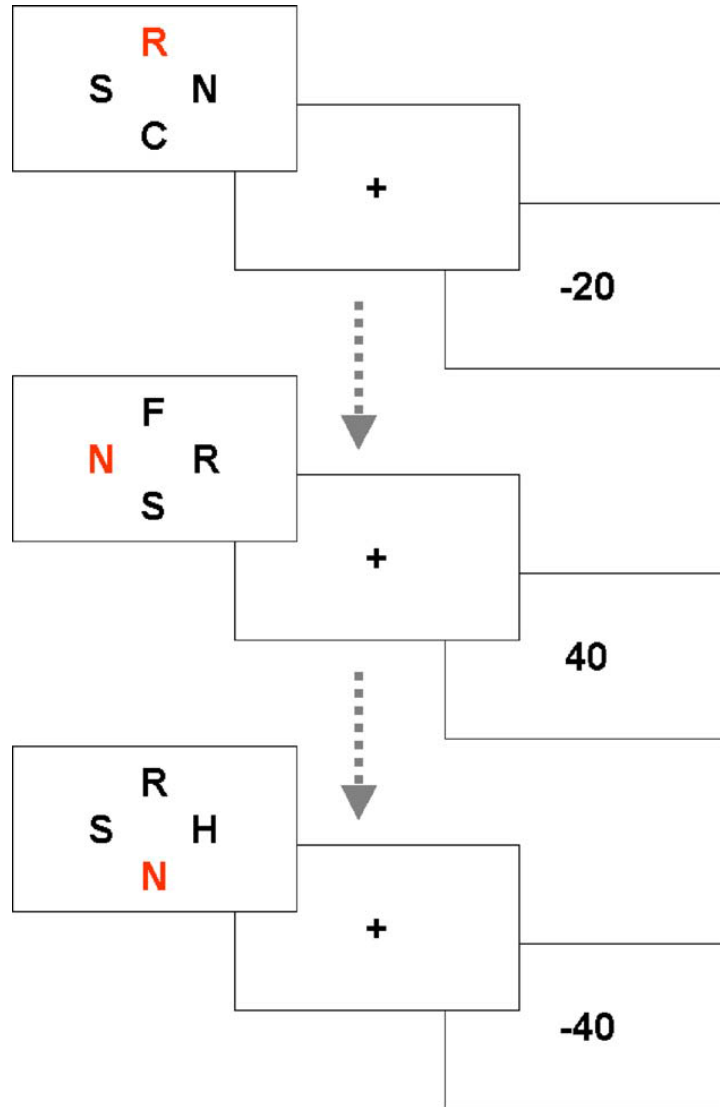

Figure 3. Expected risk effects in ACC. (A) Exploratory analysis of the dorsal ACC identified a region of interest in right ACC (Talairach 9, 27, 29) that showed significant effects of both error likelihood and anticipated consequence magnitude in the low-gambling (risk averse) individuals. (B) A confirmatory analysis showed that in contrast with the low-gambling group, both error-likelihood and anticipated error-magnitude effects were virtually absent in the more risk-tolerant high-gambling group. HM, high error magnitude; HE, high error likelihood; LM, low error magnitude; LE, low error likelihood. Except for conflict and error effects, all conditions reflect activation in correct go trials only.

Età e decision making

- Dopaminergic and serotonergic systems are subject to change during aging.
- Receptor loss and severe structural changes in PFC and striatum have been reported.
- Associated with a progressive decline in episodic memory, working memory, and processing speed. and deficits in tasks requiring adaptation to external feedback of right or wrong, or task-switching.
- **Are there structural and functional alterations of the reward system leading to impairments in reward processing, learning stimulus reinforcement associations, and reward-based decision-making?**

Età e decision making



Probabilistic object reversal task . Four out of six letters (C, F, H, N, R, S) were presented simultaneously on a screen. The participants had to choose one of the letters via button-press on a four-button mouse (chosen letters are marked in red here). After a randomized delay, participants received an abstract non-monetary feedback cue (40, 20, 0, -20, -40 points). To collect as many points as possible participants had to search for the most profitable letter (“N” in this case) by trial and error.

To assess flexible relearning the feedback schedule covertly changed after participants had reached a predefined learning criterion, i.e. after the most profitable letter was chosen in more than 80% of successive trials, and another letter was associated with the maximum feedback (bottom).

Età e decision making

YOUNG

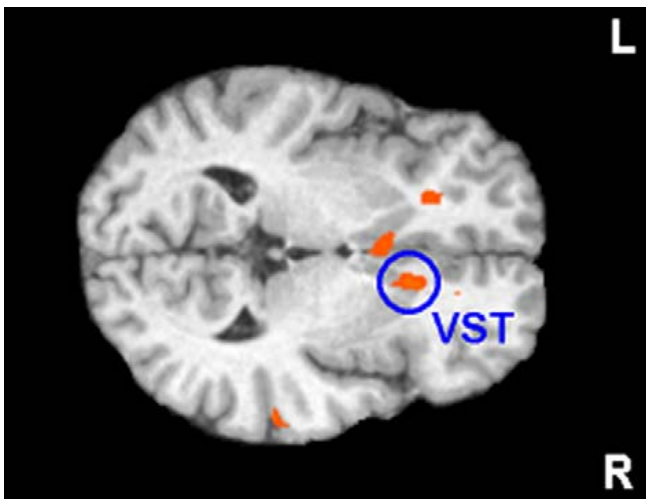

Fig. 2. Neural correlates of reward association learning in young subjects. Right ventral striatum ($x=12/y=18/z=3$) showed greater responses to reward cues after stimulus reward associations had been learned (LEARNED>SEARCH trials; $n=8$, $p<0.005$; [51]). VST, ventral striatum.

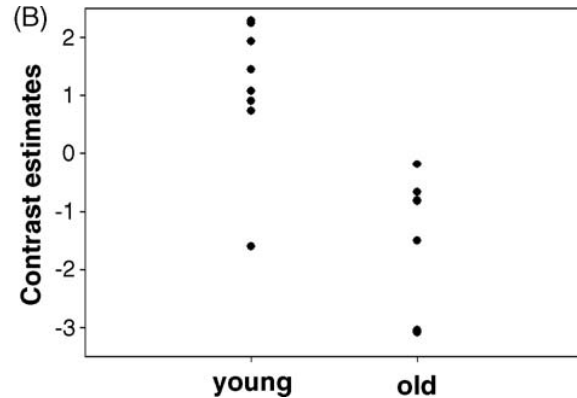
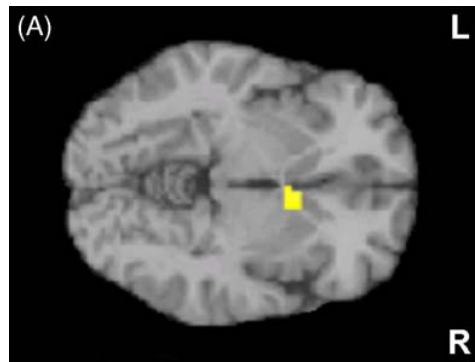
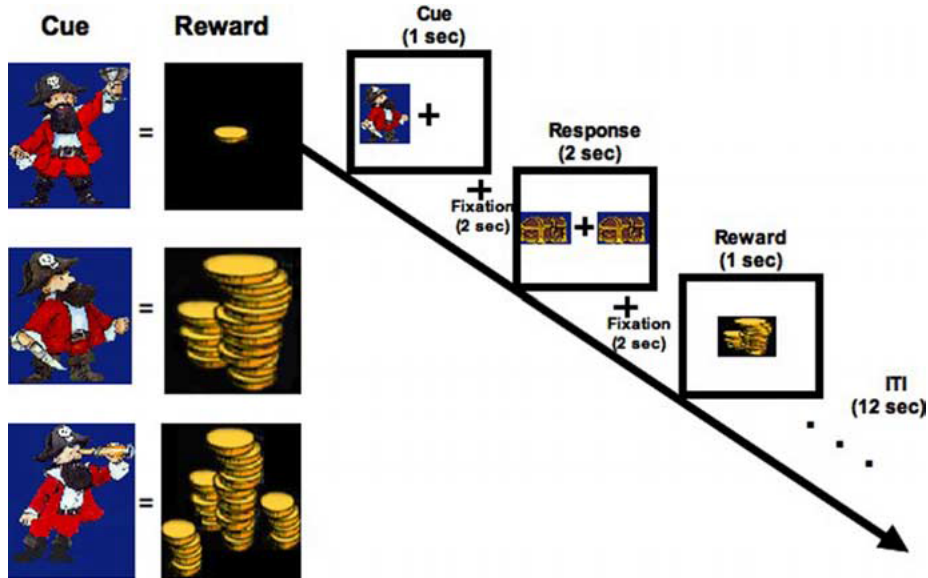

Fig. 3. Age effects on neural correlates of reward association learning. (A) Statistical map of a group comparison between young and older adults (preliminary data, 8 young and 8 older participants). Comparing LEARNED to SEARCH trials revealed greater activation of right ventral striatum ($x=8/y=12/z=-5$) during reward processing in young relative to older adults. (B) Contrast estimates in ventral striatum in the young and older participants, respectively [53].

Età e decision making

Earlier Development of the Accumbens Relative to Orbitofrontal Cortex Might Underlie Risk-Taking Behavior in Adolescents



Behavioral paradigm. Left panel, Three cues were each paired with a distinct reward value that remained constant throughout the experiment. Right panel, The paradigm consisted of a cue, response, and reward that were temporally separated in time with 12 s ITI

One of three pirate cartoon images was presented in pseudorandom order on either the left or right side of a centered fixation for 1000 ms. After a 2000 ms delay, subjects were presented with a response prompt of two treasure chests on both sides of the fixation (2000 ms) and instructed to press a button with their right index finger if the pirate was on the left side of the fixation or their right middle finger if the pirate was on the right side of the fixation.

After another 2000 ms delay, reward feedback of either a small, medium, or large amount of coins was presented in the center of the screen (1000 ms). Each pirate was associated with a distinct reward amount.

Subjects were not rewarded if they failed to make a response or if they made an error; in both cases, they received an error message at the time they would normally receive reward feedback.

Subjects were guaranteed \$50 for participation in the study and were told they could earn up to \$25 more, depending on performance (as indexed by reaction time and accuracy) on the task. Although the reward amounts were distinctly different from one another, the exact value of each reward was not disclosed to the subject.

Età e decision making

Earlier Development of the Accumbens Relative to Orbitofrontal Cortex Might Underlie Risk-Taking Behavior in Adolescents

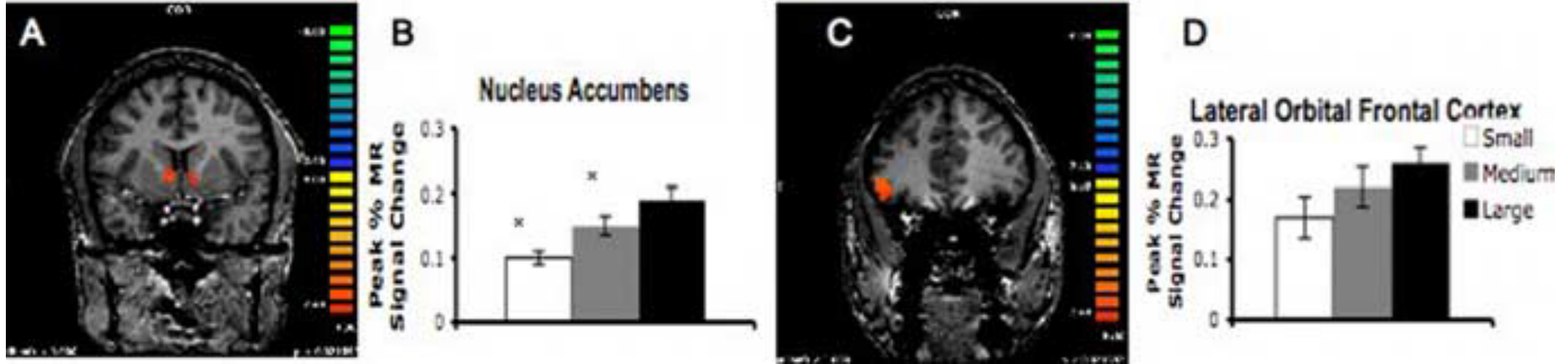

Localization of nucleus accumbens (A) and orbital frontal cortex (C) activation to reward. There was a main effect of reward value in the nucleus accumbens (B) [right (x6, y5, z2) and left (x8, y6, z2)] but not in the right lateral orbital frontal cortex (x46, y31, z1) (D).

Età e decision making

Earlier Development of the Accumbens Relative to Orbitofrontal Cortex Might Underlie Risk-Taking Behavior in Adolescents

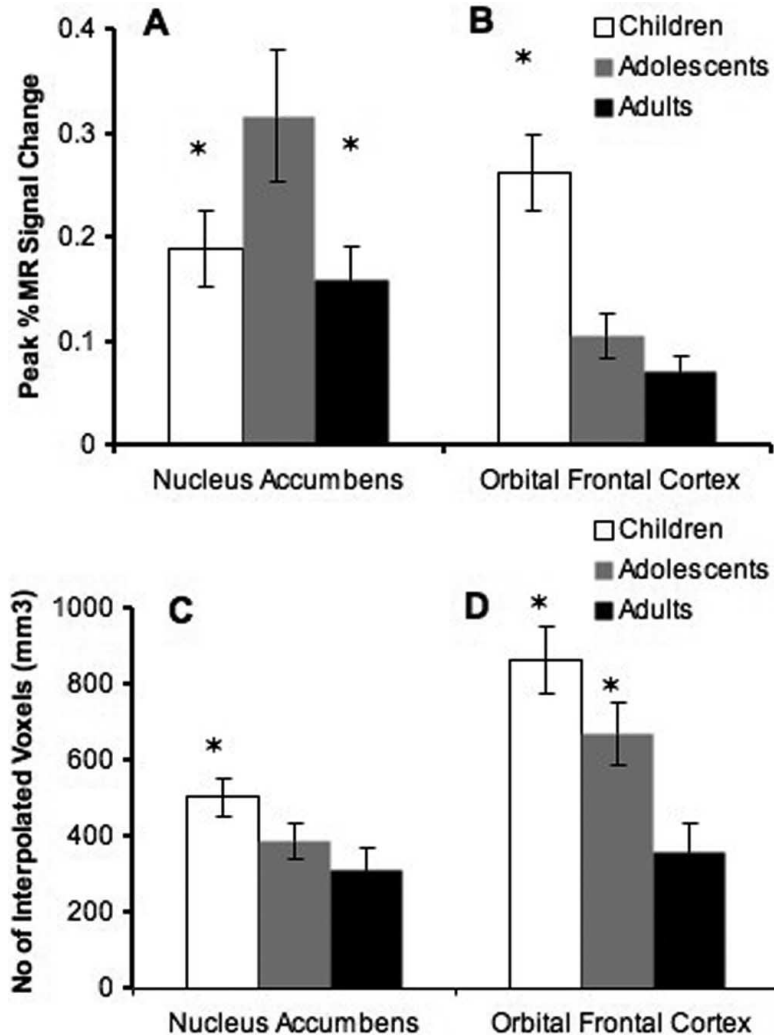

Magnitude and extent of accumbens and OFC activity to reward. A, Adolescents showed exaggerated percent change in MR signal to large reward relative to children and adults in the accumbens. B, In the OFC, children had the greatest percent change in MR signal relative to adolescents and adults. C, Children showed the largest volume of activity in the accumbens relative to adolescents and adults. D, Children and adolescents showed greater volume of activity in the OFC relative to adults.

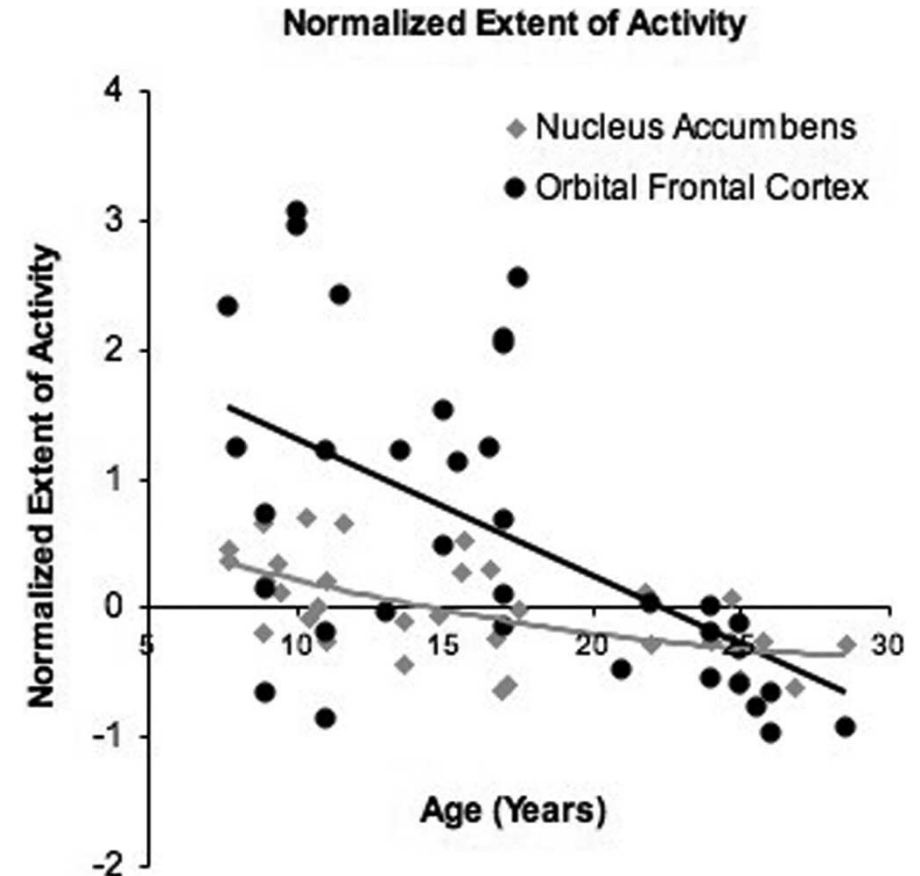

Età e decision making

Earlier Development of the Accumbens Relative to Orbitofrontal Cortex Might Underlie Risk-Taking Behavior in Adolescents

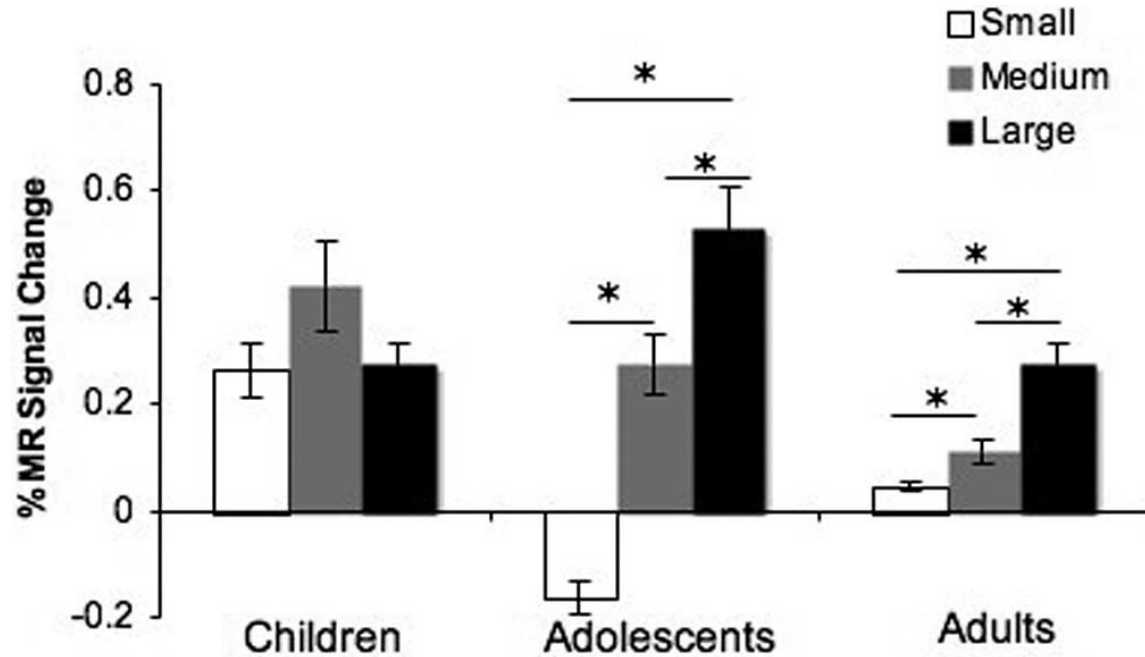

Percent change in MR signal \approx 5–6 s after the response relative to pretrial baseline for each age group, showing an exaggerated change in accumbens activity in adolescents relative to children or adults for the small and large reward trials.

Rimpianto

- A seguito di perdite al gioco c'è attivazione di amigdala e corteccia orbitofrontale=> dovuta alla paura delle conseguenze? Rimpianto?

Subjects selected between two gambles wherein regret was induced by providing information about the outcome of the unchosen gamble.

Increasing regret enhanced activity in the medial orbitofrontal region, the anterior cingulate cortex and the hippocampus.

Across the experiment, subjects became increasingly regret-averse, a cumulative effect reflected in enhanced activity within medial orbitofrontal cortex and amygdala. This pattern of activity reoccurred just before making a choice, suggesting that the same neural circuitry mediates direct experience of regret and its anticipation.

These results demonstrate that medial orbitofrontal cortex modulates the gain of adaptive emotions in a manner that may provide a substrate for the influence of high-level emotions on decision making.



Figura 15.16 Localizzare il rimpianto

Mentre gli uomini prendono decisioni sbagliate e dispendiose, di cui si pentono durante un gioco economico, l'attività nell'amigdala (Amg) e nella corteccia prefrontale (soprattutto la corteccia orbitofrontale, od OFC) aumenta, indicando un aumento della loro avversione verso la perdita. (Da Coricelli *et al.*, 2005, per gentile concessione di Angela Sirigu.)

Rimpianto

On each trial, the subject viewed two gambles where different probabilities of financial gain or loss were represented by the relative size of colored sectors of a circle. The preferred gamble was indicated by the subject by a left or right button press. Once selected, the chosen gamble was highlighted on the screen by a green square. A rotating arrow then appeared in the center of the gamble circle, stopping after 4 s. The outcome of the selected gamble, indicated by the resting position of the arrow, resulted in financial gain or loss for the subject. Half of the trials were 'choose' trials; in half of those, only the outcome of the selected gamble was given to the subject ('partial feedback choose', PC). In the other half, the outcome of both selected and unselected gambles were available ('complete feedback choose', CC). An equal number of trials were 'follow' trials, in which the subject was informed that the computer would randomly choose one of the two gambles. A green square appeared behind one of the two gambles, and the subject had to press a button on the corresponding side. Follow trials were likewise divided into complete feedback ('complete feedback follow', CF) and partial feedback ('partial feedback follow', PF) trials.

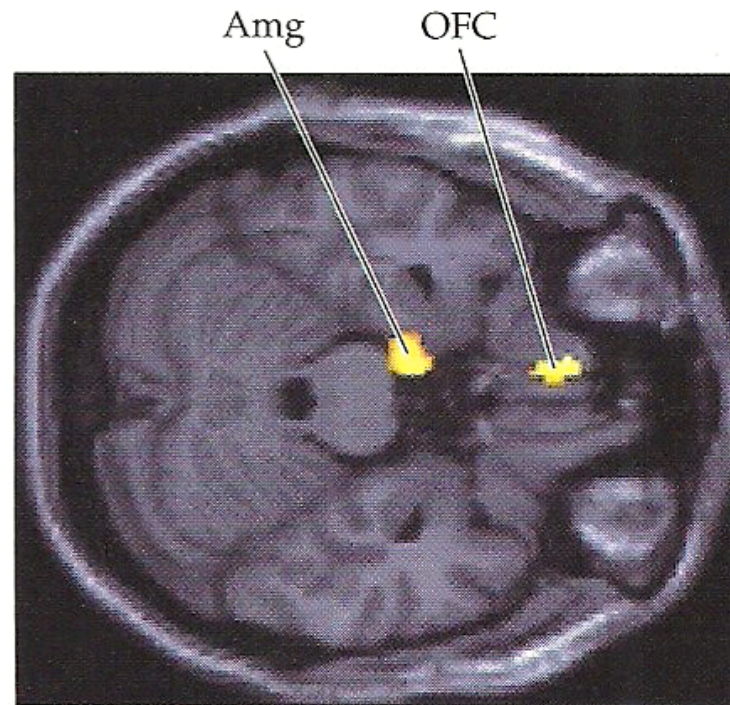
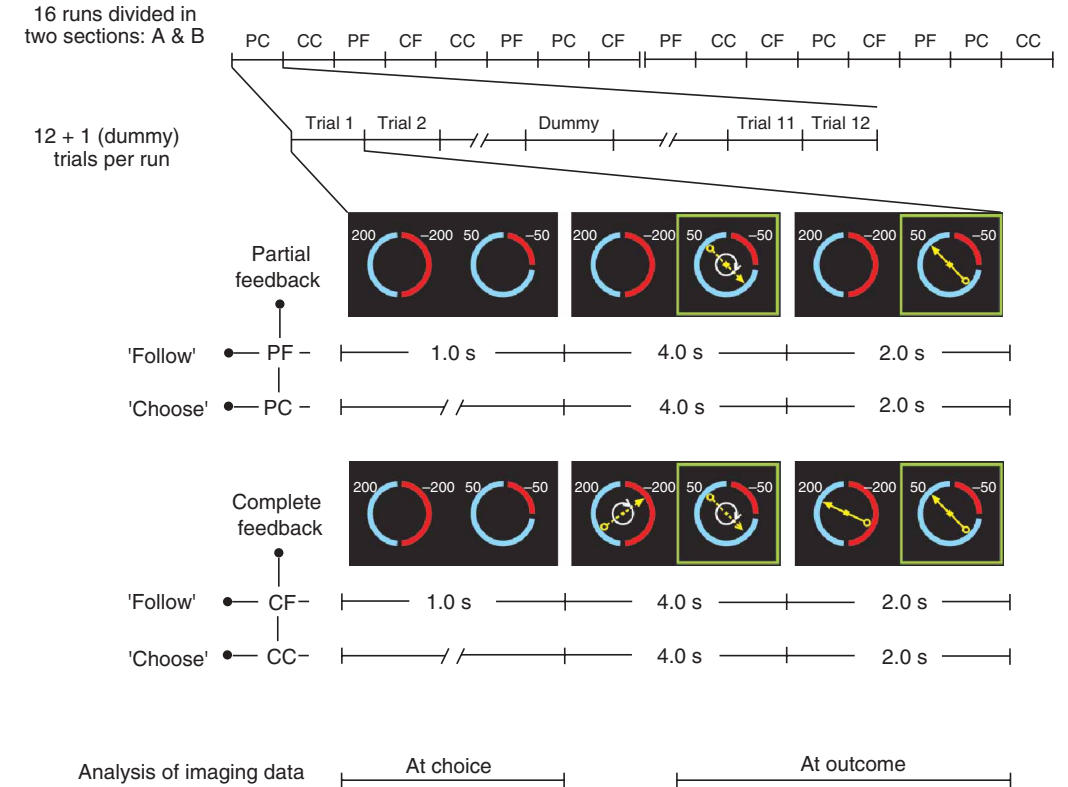

Rimpianto

Activity at outcome is related to win and loss. Activity within the ventral striatum, discriminated between financial gain and loss at trial outcome. We found activation of anterior ventral striatum during wins and a relative deactivation during losses solely in 'choose' trials, in which the subject was responsible for the choice (that is, when the subject rather than the computer selected between two gambles). The bottom panel plots the average parameter estimates for relative difference in BOLD activity at outcome for wins and losses in 'choose' and 'follow' trials. In other words, this area processes mismatches between predicted and actual outcome and is activated when an outcome is better than expected and relatively deactivated in the alternative case.

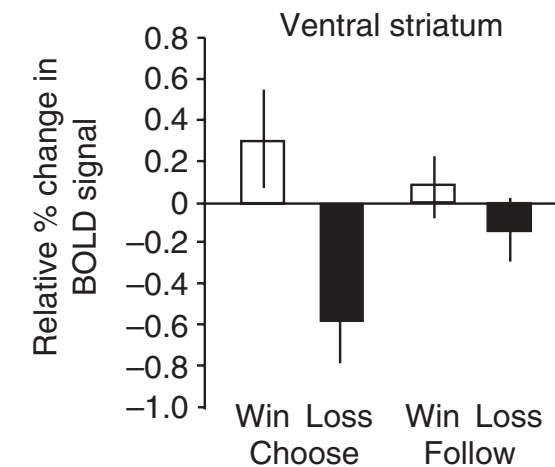
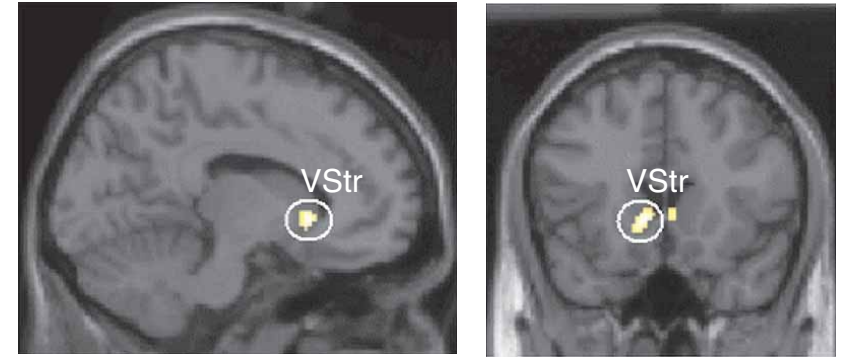

Rimpianto

Subjects selected between two gambles wherein regret was induced by providing information about the outcome of the unchosen gamble.

Increasing regret enhanced activity in the medial orbitofrontal region, the anterior cingulate cortex and the hippocampus.

Across the experiment, subjects became increasingly regret-averse, a cumulative effect reflected in enhanced activity within medial orbitofrontal cortex and amygdala. This pattern of activity reoccurred just before making a choice, suggesting that the same neural circuitry mediates direct experience of regret and its anticipation.

These results demonstrate that medial orbitofrontal cortex modulates the gain of adaptive emotions in a manner that may provide a substrate for the influence of high-level emotions on decision making.

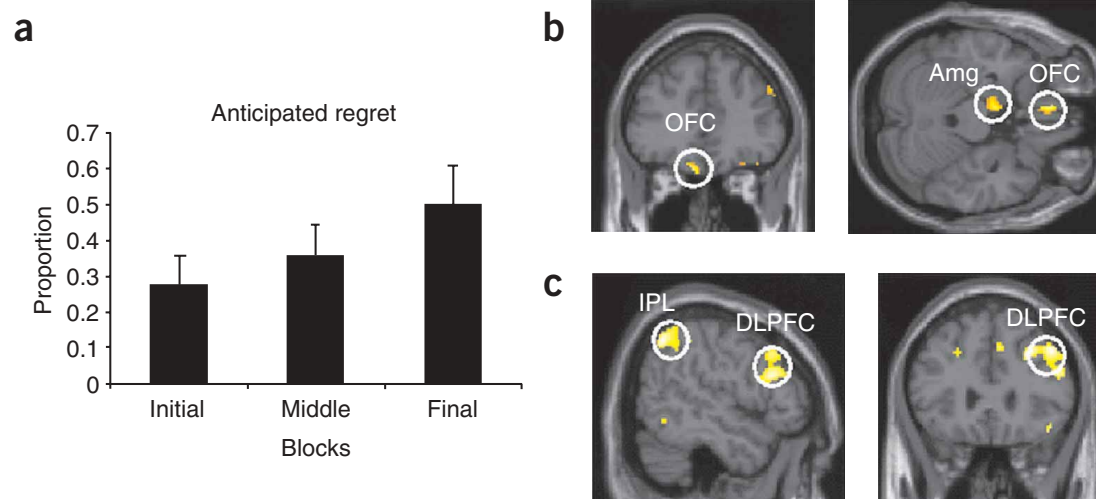

Activity at choice: learning from the experience of regret. (a) Proportion of choice related to anticipated regret. Anticipated regret increased over time as the experiment proceeded. (b) Activity at choice reflecting cumulative regret. We found activity in the medial left amygdala (Amg; and medial OFC). (c) Activity reflecting prior regret at choice. Experience of regret in the preceding trial profoundly influenced choice-related activity, enhancing responses in right dorsolateral prefrontal (DLPFC), right lateral OFC, and inferior parietal lobule).

Regole morali

- Morality depends on a set of cultural rules that regulate interpersonal behaviour and provide a basis for social cohesion.
- The interpretation of moral transgressions and their affective consequences depends on whether the action is intentional or accidental, and whether one is the agent of or witness to the action.
- Participants were asked to make evaluations regarding the degree of inappropriateness of social behaviours described in stories in which they themselves, or someone else, transgressed social norms either intentionally or accidentally.
- The amygdala was activated when participants considered stories narrating their own intentional transgression of social norms. This result suggests the amygdala is important for affective responsiveness to moral transgressions.

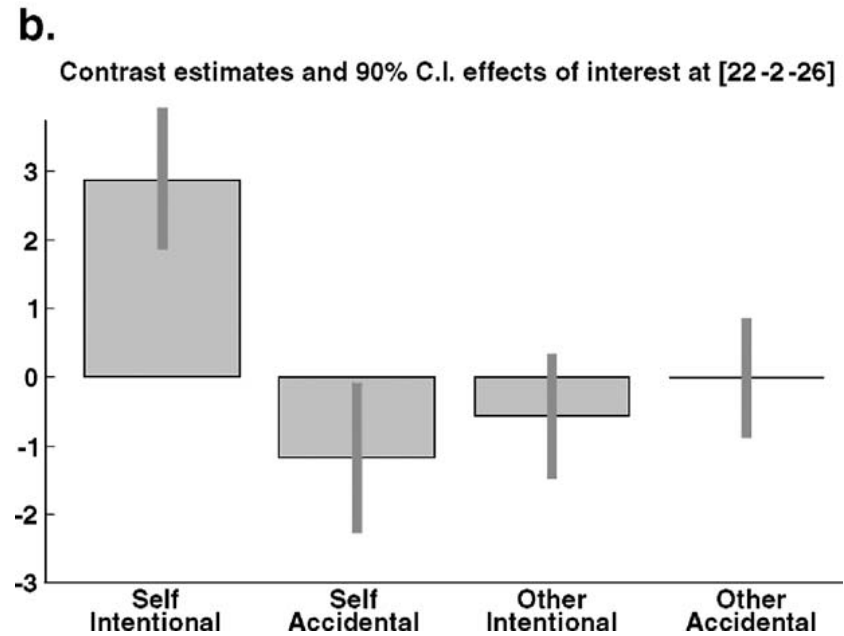
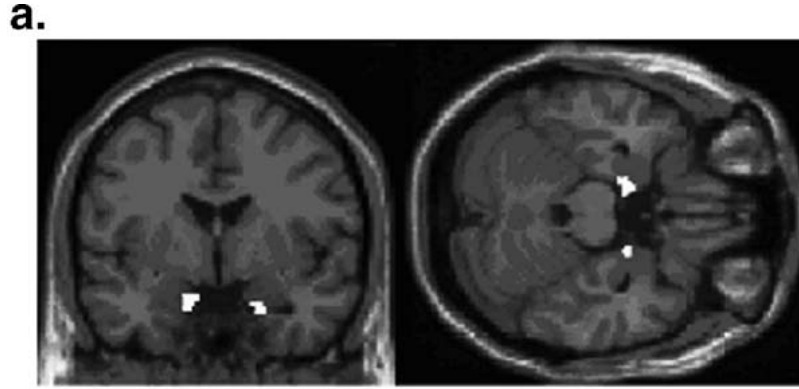

Fig. 1. Amygdala activation to one's own moral violation. (a) Statistical parametric map, overlaid onto the canonical MNI brain, showing the voxels within the amygdala where a significant interaction between Intentionality in violating social norms and Agency was observed ($P < 0.005$); (b) Parameter estimates of the local maxima in the right amygdala ($x, y, z = 22, -2, -26$) show greater response when the social violation was performed by the self and was intentional, as compared to the other conditions. C.I.: Confidence Interval.