

INSTRUCTION MANUAL

TC 170/TC 171

FET SPECTROSCOPY PREAMP

* * * * CAUTION * * * *

1. Wiring of the power connector of this preamplifier is directly compatible with the following main amplifiers:

- TENNELEC TC 240 Series
 - TENNELEC TC 205A with serial numbers above 1999
 - TENNELEC TC205A with serial numbers up to 1999 if the connector labelled "OTHER" is used.
 - TENNELEC TC 222 when the internal cable is plugged into the "OTHER" connector.
- All standard Aptec, Canberra, EG&G Ortec and PGT

In addition to the power leads, this TENNELEC preamplifier contains signal and test-pulse coaxial cables. These cables are used when the preamplifier is connected to TENNELEC TC 240 series amplifiers and to TENNELEC TC 205A amplifiers with serial numbers above 1999, thereby avoiding the need to use separate ones. With the TENNELEC TC 222, TC 205A with serial numbers up to 1999, and all other amplifiers, signal and test-pulse cables separate from the power cable must be used.

Differentially-driven cables are used in TENNELEC preamplifiers for ground-loop noise reduction. See Section 3.2.3 for details.

If there are any questions regarding the compatibility of the power connector of this instrument, please contact the TENNELEC Marketing Department for assistance.

* * * * * WARNING * * * * *

Improper connection to the shaping amplifier preamplifier power connector may permanently damage the amplifier and/or preamplifier. TENNELEC assumes no liability for such instrument damage.

* * * * *

TABLE OF CONTENTS

<u>Section</u>	<u>Page</u>
1.0 INTRODUCTION	1
2.0 SPECIFICATIONS	2
2.1 PERFORMANCE	2
2.2 CONNECTORS	6
2.3 POWER REQUIREMENTS	7
2.4 OTHER INFORMATION	7
3.0 INSTALLATION	7
3.1 POWER	7
3.2 CONNECTIONS	7
3.2.1 DETECTOR CONNECTION	7
3.2.2 BIAS SUPPLY CONNECTION	8
3.2.3 ENERGY OUTPUT CONNECTION	9
3.2.4 TIMING OUTPUT CONNECTION	12
3.2.5 TEST INPUT CONNECTION	13
3.3 GENERAL PRECAUTIONS	14
3.3.1 FET PROTECTION	14
3.3.2 APPLYING BIAS VOLTAGE	14
3.3.3 DETECTOR BIAS NETWORK	15
3.3.4 BIAS LEVEL	16
4.0 ADJUSTMENTS	17
4.1 DC OFFSET VOLTAGE	17
4.2 RISETIME	18

<u>Section</u>	<u>Page</u>
5.0 NOISE	20
5.1 NOISE PERFORMANCE	20
5.2 NOISE MEASUREMENTS	27
6.0 COUNT RATE EFFECTS	28
6.1 RESOLUTION	28
6.2 NONLINEARITY	31
7.0 PREAMPLIFIER MODIFICATIONS	32
7.1 REMOVING THE CASE	32
7.2 CHANGING PREAMPLIFIER SENSITIVITY	32
7.3 FRONT-END MODIFICATIONS	32
7.4 MODIFICATION OF FET DRAIN CURRENT	34
8.0 SHIPPING DAMAGE	34
9.0 SERVICING	34
10.0 WARRANTY	34

TABLE OF FIGURES

	<u>Page</u>
Electronic Noise vs Equivalent Detector Capacitance (Shaping Time of 2.0 usec.)	3
Electronic Noise vs Equivalent Detector Capacitance (Shaping Time of 0.5 usec.)	3
Typical Risettime vs Equivalent Detector Capacitance	4
Typical Transient Response, TC 170	4
Balanced Signal Cable System	11
TC 170 Adjustment Locations	17
TC 171 Adjustment Locations	18
Electronic Noise vs Equivalent Detector Capacitance (TC 170, 2.0 usec Shaping Time)	21
Electronic Noise vs Equivalent Detector Capacitance (TC 170, 1.0 usec. Shaping Time)	22
Electronic Noise vs Equivalent Detector Capacitance (TC 170, 0.5 usec Shaping Time)	23
Electronic Noise vs Equivalent Detector Capacitance (TC 171, 2.0 usec Shaping Time)	24
Electronic Noise vs Equivalent Detector Capacitance (TC 171, 1.0 usec Shaping Time)	25
Electronic Noise vs Equivalent Detector Capacitance (TC 171, 0.5 usec Shaping Time)	26
The Shape of a Typical Spectral Line (Gaussian)	28
Pulse Shape at the Output of a Preamplifier	30
The Waveform at the Output of a Preamplifier with Pulses Applied to the Input in Rapid Succession	30
170 SCHEMATIC DIAGRAM (Sheet 1 of 1)	36
171 SCHEMATIC DIAGRAM (Sheet 1 of 1)	37

1.0

INTRODUCTION

The TENNELEC TC 170 and TC 171 are low-noise, fast risetime charge-sensitive preamplifiers designed to provide optimum energy and timing performance from any charged particle detector.

The TC 170 is ac coupled and intended for use with detectors having an equivalent capacitance from 0 pF to 100 pF, including room-temperature silicon detectors and low-energy, low-voltage proportional counters.

The TC 171 is also ac coupled and intended for use with detectors having an equivalent capacitance of 100 pF or more, including room-temperature silicon detectors.

Each of the preamplifiers consists of a single, charge-sensitive feedback loop which affords minimal noise degradation of the input field-effect transistor (FET), very fast risetime, and excellent power supply noise rejection. Additionally, both preamplifiers provide a fast, transformer-coupled timing output (differentiation time constant of 100 nsec) which may be directly coupled to most timing instruments. Signal polarity of the timing output is opposite to that of the energy output.

An SHV connector is provided for introducing up to 2kV of detector bias through a load-resistor network. In the TC 170, the network consists of two 100 megohm resistors and a 10 megohm resistor, all three in series. In the TC 171, one each 100 megohm and 10 megohm resistors are series connected. These resistors maybe shorted across allowing a trade-off between the conflicting requirements of high resistance for good noise performance and low resistance for detectors with high leakage current. See Section 3.3.3 for details.

Each preamplifier has a removable PET protection network. See Section 3.2 for details.

Also included in each preamplifier is a screwdriver-adjustable resistor for optimizing the risetime with various detectors. Access is through a hole in the top of the case (the hole is covered with a press-in plug).

2. The TC 170/TC 171 Charge-Sensitive Preamplifiers are shipped with a network installed that protects the input field-effect transistor (FET) from damage due to abnormal transients (see Section 3.3.2 for a detailed discussion of this topic). This network slightly degrades noise performance and risetime, with the degradation becoming worse as detector capacitance increases. However, in systems where performance is controlled by the detector rather than the preamplifiers (usually the case with room temperature surface-barrier detectors and gas filled proportional counters), the degradation may be negligible. Where ultimate performance is required, the network can be disconnected. See Section 3.3.1 for details.

3. The detector load in the TC 170 is comprised of three resistors connected in series, and in the TC 171, two resistors. With room temperature surface-barrier detectors, detector leakage current may be high enough to cause excessive voltage drop in the load network, requiring one or more of the resistors to be jumpered. See Section 3.3.3 for details.

2.0 SPECIFICATIONS

2.1 PERFORMANCE

NOISE (FWHM referred to a silicon detector with $W = 3.6$ eV per electron-hole pair).

MODEL	DETECTOR CAPAC. (pF)	NOISE (keV FWHM)			RISETIME (2) (nsec 10%-90%)	
		TYPICAL (1)		MAX. (1)	TYP. MAX.	
		$t_s = 2.0$	$t_s = 0.5$	$t_s = 2.0$		
TC 170	0	0.95	1.2	1.4	3.5	5.0
	10	1.1	1.5		3.5	
	20	1.3	1.9		4.2	
	50	1.8	3.1		5.2	
	100	2.8	5.1	3.3	6.5	10.0
TYPICAL INTERCEPT: 0.95 keV TYPICAL SLOPE: 18.0 eV/pF						
TC 171	0	2.3	4.2		7.0	
	100	3.2	6.0	4.0	7.5	10.0
	200	4.5	8.2		7.9	
	300	5.6	10.0		9.0	
	500	7.8	15.0		12.0	
	1,000	13.0	26.0	15.0	16.0	20.0
TYPICAL INTERCEPT: 2.34 keV TYPICAL SLOPE: 10.9 eV/pF						

(1) " t_s " refers to shaping time in usec. With TERNELEC amplifiers such as the TC 205A, TC 222 and earlier designs, the peaking time (measured from the 1% level) is approximately twice the shaping time as indicated on the front panel. See Figures 2.1 and 2.2 for graphs of TC 170/TC 171, Noise versus Equivalent Detector Capacitance at shaping times of 2.0 usec and 0.5 usec.

(2) Based on a 10 MeV equivalent input, risetime adjustments optimized at each measurement, E and T outputs terminated in 50 ohms, measurements made with an external test-input capacitor. See Figure 2.3 for a graph of the TC 170/TC 171, Risetime as a Function of Equivalent Detector Capacitance. The typical transient response of the TC 170 is shown in Figure 2.4.

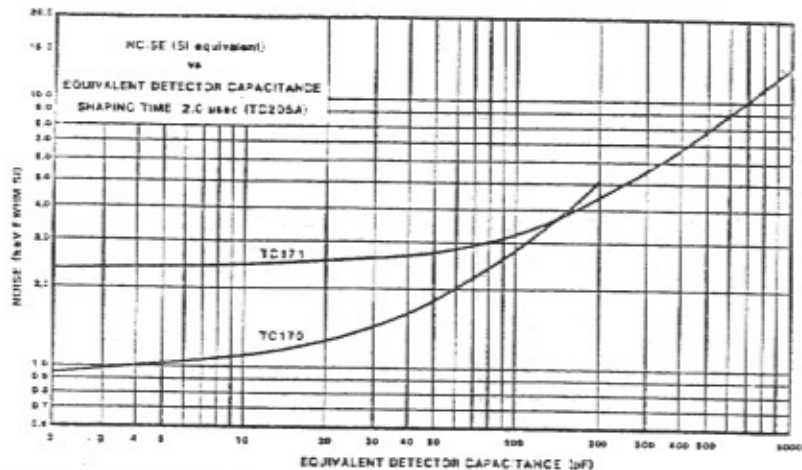

Figure 2.1 Electronic Noise vs Equivalent Detector Capacitance (Shaping Time of 2.0 usec.)

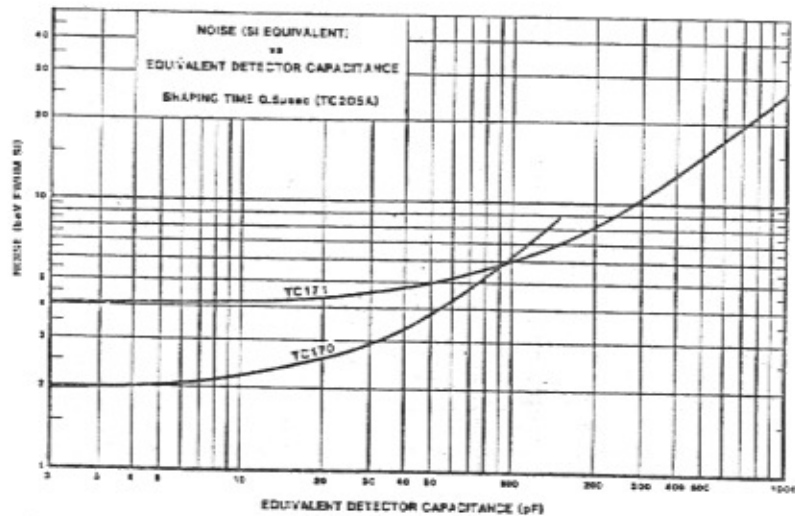

Figure 2.2 Electronic Noise vs Equivalent Detector Capacitance (Shaping Time of 0.5 usec.)

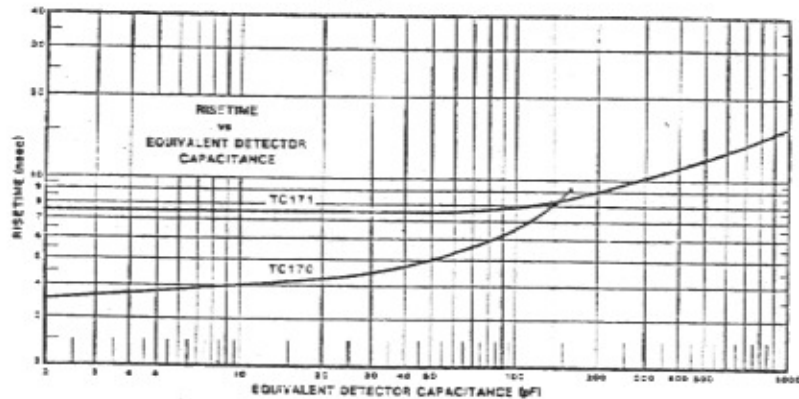

Figure 2.3 Typical Risetime vs Equivalent Detector Capacitance

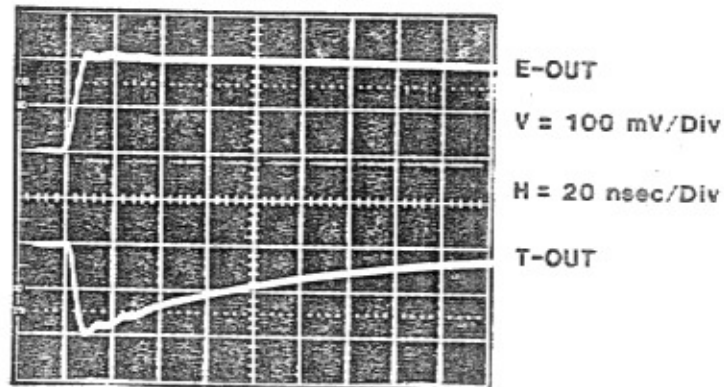

Figure 2.4 Typical Transient Response, TC 170

SENSITIVITY

(NOMINAL)

TC 170

TC 171

44 mV/MeV, Si

20 mV/MeV, Si

FEEDBACK CAPACITOR

TC 170

TC 171

1 pF

2.2pF

DECAY TIME CONSTANT (NOMINAL)			
E OUT	TC 170	1 nsec	
	TC 171	2.2 nsec	
T OUT	TC 170, TC 171	100 nsec	
DETECTOR LOAD RESISTOR			
	TC 170	100M + 100M + 10M	
	TC 171	100M + 10M	
SIGNAL POLARITY INPUT		Either	
E OUTPUT		Inverse of input	2.2
T OUTPUT		Same as input	
TEST CAPACITOR			
	TC 170	1 pF	
	TC 171	2.2 pF	
DETECTOR BIAS		±2,000V Maximum	
NONLINEARITY, INTEGRAL ($t_p = 2\mu\text{sec}$, E OUT unterminated) 0 to ±10V		≤0.05% max., ≤0.03% typ.	
0 to ±7V		≤0.02% max., ≤0.005% typ.	
NONLINEARITY, DIFFERENTIAL ($t_p = 2\mu\text{sec}$, E OUT unterminated)		≤0.03% typical, -9V to +7V	
MAXIMUM ENERGY			
	TC 170	200 MeV @ 5 c/s Si	
	TC 171	400 MeV @ 5 c/s Si	
COUNT RATE CAPABILITY (5% of pulses in non-linear range)			
	TC 170	1.6 × 10 ⁷ c/s @ 1MeV Si 1.5 × 10 ⁵ c/s @ 10MeV Si	
	TC 171	3.6 × 10 ⁷ c/s @ 1MeV Si 3.5 × 10 ⁵ c/s @ 10MeV Si	

CONVERSION GAIN		
TEMPERATURE STABILITY		
	TC 170	≤ ±50 ppm/°C, 0-50°C
	TC 171	≤ ±75 ppm/°C, 0-50°C
DYNAMIC INPUT CAPACITANCE		
	TC 170	≥40,000 pF minimum ≥80,000 pF typical
	TC 171	≥60,000 pF minimum ≥200,000 pF typical
CONNECTORS		
INPUT (DETECTOR)		BNC (UG-290/CA), ac coupled
H.V. IN (DETECTOR BIAS)		SHV (AMP 51454-2), ±2kV maximum
TEST IN		BNC (UG-1094/U), $Z_{in} = 50$ ohms
E OUT		BNC (UG-1094/U), dc coupled, $Z_c = 50$ ohms ±1%, dc offset approximately -100mV
T OUT		BNC (UG-1094/U), ac coupled, $Z_c = 50$ ohms ±1%, decay constant = 100 nsec ±10%
POWER		9-pin male, Amphenol 17-20090 or equivalent

NOTE: The power connector includes connections for a cable containing ±12V wires, ±24V wires, a power ground wire, and three RG-174/U cables. One cable is the signal cable which duplicates the function of the E-OUT connector but is isolated from it by a separate 50-ohm ±1% terminating resistor. Another cable is grounded through a 50 ohm ±1% resistor and constitutes the source of out-of-phase ground-loop noise signal when the preamplifier is used with a differential-input main amplifier, and the third cable carries the test pulse signal. This last cable is in parallel with the TEST IN connector and shares a common 50 ohm ±1% terminating resistor.

2.3	POWER REQUIRED	
	TC 170	+24V @ 35mA; +12V @ 12mA -24V @ 15mA; -12V @ 12mA
	TC 171	+24V @ 65mA; +12V @ 12mA -24V @ 15mA; -12V @ 12mA
2.4	OTHER INFORMATION	
	WEIGHT	
	(SHIPPING)	3.0 lbs (1.4 kg)
	(NET)	1.1 lb (0.5 kg)
	DIMENSIONS	(L x W x H) 4 x 3 x 1.5 inches; 10.2 x 7.6 x 3.8 cm.
	WARRANTY	One year
	INSTRUCTION MANUAL	One provided with each instrument ordered.
	ACCESSORIES	One (1) TENNELEC NC-PAC-10, 10 ft. preamplifier signal and power cable provided with each preamplifier ordered; Amphenol 17-20050 to Amphenol 17-10090 connectors.

3.0 INSTALLATION

3.1 POWER

The TC 170/TC 171 preamplifiers are not self-powered and must be connected via the power cable to a main amplifier with provisions for providing preamplifier power or a separate preamplifier power supply. Refer to the CAUTION at the beginning of the manual before connecting the TC 170/TC 171 power cable to TENNELEC main amplifiers other than the TC 240 series.

3.2 CONNECTIONS

3.2.1 DETECTOR CONNECTION

To preserve the low-noise characteristics of the system, the capacitance to ground at the input of the preamplifier should be kept minimal. If a cable between detector and preamplifier must be used, it

should be as short as possible and it must be shielded with one end of the shield connected to the detector housing and the other to the preamplifier housing. Doubly shielded cable (RG71/U) is preferable to singly shielded cable (RG62/U).

To avoid microphonics, it is desirable that the geometrical relationship between detector and preamplifier be kept rigidly fixed.

The length of cable connecting the preamplifier and the detector should be kept to a minimum for reasons of stability in addition to noise considerations. The cable connecting the preamplifier and detector introduces a phase shift into the preamplifier feedback loop which adversely affects stability. The cable should be kept as short as possible. A maximum length of cable cannot be assigned to the infinite number of detector and cable combinations, but a maximum length for the TC 170 is typically 3 ft. and for the TC 171, 2 ft.

The noise performance of the preamplifier can be estimated from the sum of connecting cable and detector capacitance. The noise as a function of this input capacitance is shown in Figures 2.1 and 2.2 for shaping times of 2 usec and 0.5 usec.

3.2.2 BIAS SUPPLY CONNECTION

In the TC 170/TC 171, the bias connection is routed through the preamplifier case.

If a battery pack is used for bias, no special precautions need be taken in cable routing to avoid noise pickup provided the case of the battery pack is connected to the preamplifier.

If a power line operated supply is used, or if a battery pack is used which is grounded to the main amplifier frame, then it is desirable to take the following precautions to avoid ground-loop pickup.

- a. Locate the power supply physically close to the main amplifier.
- b. Ground the supply to the main amplifier with large-gauge wire or shield braid at least 1/4" (6mm) wide.

- c. Cut the high voltage cable to approximately the same length as the preamplifier signal cable and twist or tape the two together.
- d. Never plug the main amplifier and HV supply into different wall outlets. If necessary, use a local distribution box for all components of a spectrometer system to avoid making the building part of a ground loop.

- b. Cut the signal and test pulse cables to approximately the same length as the $\pm 12V$, $\pm 24V$ wires. Twist or tape all cables into one bundle.

The purpose of instruction (a) is to prevent power supply noise spikes (which nearly always exist between widely spaced ground points in a NIM bin) from appearing in series with the signal ground returns. The purpose of instruction (b) is to avoid local radio station pickup which frequently occurs because of the loop-antenna effect in a network of spread-out cables.

When a long cable run is necessary in an electrically noisy environment, a balanced-to-ground signal cable system may be needed to reduce noise pickup to an acceptable level. In this arrangement (Figure 3.1), two signal cables of matched length and close proximity are used to connect the preamplifier to a differential input stage on the main amplifier. This feature is directly compatible with TC 205A's of serial number greater than 1999. The "OTHER" power connector on TC 205A's with serial numbers up to 1999 will require rewiring to provide this feature. The preamplifier power connector on the TC 222 can be modified to accept this function if the preamplifier power connector is modified to provide $\pm 12V$ and $\pm 24V$ (the TC 222 preamplifier power connectors must be configured to provide $\pm 12V$ and $\pm 24V$ for the TC 170 series of preamplifiers to operate). As shown in Figure 3.1 only one of the cables carries the desired signal, but both cables carry the noise signal. At the balanced input stage, the noise signals cancel, but the desired signal is unaffected.

In the TC 170 Series preamplifiers, provision for balanced operation is built into the preamplifier and the ten-foot power cable. To take advantage of this feature, the user must be sure that the main amplifier contains a balanced input stage and that Pins 3 and 8 of the cable connector (Figure 3.2) are connected to the respective inputs. Pin 2 is the signal ground connection. In a single-ended main amplifier, Pin 2 should be grounded.

3.2.3 ENERGY OUTPUT CONNECTION

The energy output (E out) is intended to drive a 50 ohm line (RG 58A/U) which may be connected directly to the input of the main amplifier. A 50 ohm termination is not required as the preamplifier is stable unterminated. The preamplifier will drive any length of cable, but for long cable lengths, cable losses must be considered.

To avoid ground loop pickup, the philosophy at TENNELEC is to route signal and test pulse cables through the same shielded wire bundle as the supply voltage wires, terminating all connections in a single multipin connector (Amphenol 17-10090 or equivalent) which attaches to the main amplifier. This feature can be used with the "OTHER" preamplifier power connectors on the TC 205A shaping amplifier having serial numbers greater than 1999. The preamplifier signal only (no test input) is available through the preamplifier shielded wire bundle to the TC 240 and TC 241. When using main amplifiers of other manufacture, it is recommended that the preamplifier power connector on the amplifier be rewired to accept the preamplifier signal and provide the preamplifier test input. This will minimize the ground loop problem by allowing the signal and test pulse lead in the power cable to be used.

If independent signal, test pulse, and power cables are used, the following pattern of connections is recommended:

- a. Place the test pulse generator as close to the main amplifier as possible.

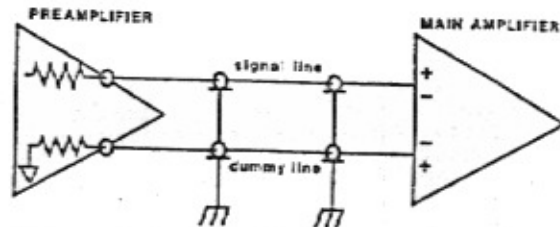

Figure 3.1 Balanced Signal Cable System

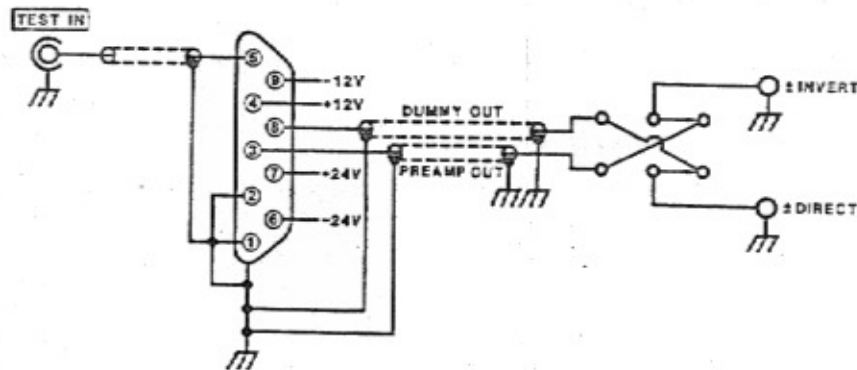

Figure 3.2 Main Amplifier Preamplifier Connector and Polarity Selector

Signal cables are terminated at the sending end by resistors R33, R38, and R40 as shown on the TC 170 schematic. In the TC 170 Series, these resistors are nominally 49.9 ohm each to match 50 ohm cables. Other cable impedances may be used by changing to resistors of appropriate value.

For best possible noise performance, linearity, transient response, and for the least possible heating in the output transistors, the receiving end (main amplifier end) of the signal cables should operate into an essentially open circuit--500 ohms or more.

If a signal cable external to the one in the preamplifier's power cable is used to join the E OUT

connector on the preamplifier to the INPUT connector of the main amplifier, a wrinkle in the waveform may be observed 3.2L nanosec from the start of the pulse, where L is the length in feet of the power cable. For a standard 10' cable, this wrinkle will occur 32 nsec from the time-zero reference, but will be of no consequence in normal operation. The distortion is caused by signal reflection in the revised coax, and the effect can be eliminated by removing R35 from the TC 170 (R38 from the TC 171). Removing the resistor isolates the unused signal cable.

3.2.4

TIMING OUTPUT CONNECTION

The timing output is intended to drive a 50 ohm system and should be connected using coaxial cable such as RG 58A/U. The timing output may be directly connected to a fast amplifier, timing filter amplifier, or fast discriminator. The polarity of the timing output is the inverse of the energy output. When not being used, the timing output should be terminated in 50 ohms for best pulse response, although this is not necessary if some leading-edge pulse distortion can be tolerated.

Timing measurements usually require cleaner waveforms than energy measurements. If the TC 170 or TC 171 is used exclusively for timing measurements, energy-signal cables should be disconnected to avoid reflections. The signal cable within the TC 170 preamplifier power cable can be disconnected by removing R35, (R38 for the TC 171).

If energy and timing measurements must be made simultaneously, waveform purity can be maintained by terminating the energy-signal cable in 50 ohms at the main-amplifier end. This applies both to the signal cable included in the power bundle or to an external signal cable, if used. In the latter case, the cable in the power bundle should be disconnected by removing the appropriate resistor (R35 for the TC 170 and R38 for the TC 171).

If the signal cable is terminated, the linearity will be degraded slightly when the product of count rate and signal amplitude approaches the upper limit of preamplifier dynamic range.

For a discussion of where on the waveform signal reflections appear, see the last paragraph of 3.2.3.

3.2.5 TEST INPUT CONNECTION

Test pulses may be applied either at the rear of the preamplifier or at the main amplifier end of the power cable. In either case, the test pulse connector is internally terminated by a 50 ohm resistor.

The test input capacitor of the TC 170 is 1 pF and the test input capacitor of the TC 171 is 2.2 pF. A pulse generator such as a TC 812 can be connected to the test input of the TC 170/TC 171 and be used to verify system operation and calibration. The detector (with bias applied) or an equivalent detector capacitance should be connected to the TC 170/TC 171 input when verifying system performance or calibration.

The transient response of the TC 170/TC 171 can best be examined by applying the test signal through an external charge coupling capacitor to the INPUT connector. Because of stray capacitive coupling and reflections from the test cable in the power supply bundle, this method will result in a more accurate representation of the transient response than using the TEST IN connector.

If a test signal must be applied other than through an external charge coupling capacitor, the accuracy of the transient response can be improved by following certain practices. If the preamplifier is used with a TENNELEC main amplifier with a TEST INPUT connector on the front panel and fully compatible as outlined at the beginning of this manual (CAUTION), the test input signal should be applied at the main amplifier. When the preamplifier is used with a main amplifier not having the above feature, the test input must be applied at the TEST IN connector of the preamplifier. When using the TEST IN connector, the accuracy of the transient response will be improved if the wire connecting the TEST IN connector to pin 5 of the power connector via the printed circuit board is disconnected. Disconnecting this wire will eliminate the reflection caused by the unterminated test cable in the power supply bundle.

3.3 GENERAL PRECAUTIONS

3.3.1 FET PROTECTION

In the TC 170/TC 171, a transistor connected as a diode is used to protect the input FET against damage from accidental short circuits. The protection network degrades the preamplifier noise slightly (refer to Section 5.1 and Figures 5.1 thru 5.6 for more detail). After the system is operable, the user may wish to disconnect the diode. This is easily done by pulling the diode lead (J2) out of the miniature jack mounted on the input Teflon standoff post and inserting the jumper (J1) across the series protection resistor. See the component placement drawing at the end of this manual for location of the jumper storage position and location of J1 and J2.

IMPORTANT: See Section 7.1 for instructions on how to properly open or remove the case.

If no resolution improvement is observed once the diode is disconnected, it is strongly recommended that the diode be reconnected. If left disconnected, the diode lead should be bent down and away from the input terminal.

3.3.2 APPLYING BIAS VOLTAGE

In the following statements, it is essential that the user recognize the distinction between rapid voltage changes at the H.V. IN connector and the SIGNAL INPUT connector.

The TENNELEC TC 170/TC 171 preamplifiers can safely withstand the application of detector bias voltage in $\pm 500V$ steps spaced 10 sec apart, with or without diode protection for the FET, if the voltage is applied through the H.V. IN connector.

Without diode protection, short circuits at the SIGNAL INPUT terminal may cause FET damage if the bias exceeds 50V. Connecting a preamplifier to a detector with bias voltage applied, either through the preamplifier or directly to the detector, is nearly equivalent to a short circuit.

With diode protection, an occasional short circuit at the SIGNAL INPUT terminal will not cause FET damage if the bias is 500V or less.

With or without diode protection, the preamplifier may be disconnected from a charged detector, but not reconnected except within the limits stated above for short-circuiting the SIGNAL INPUT terminal. When a preamplifier is disconnected from a charged detector, the SIGNAL INPUT terminal should not be short-circuited except within the limits given above. Additionally, the detector bias supply should not be disconnected without first reducing the voltage to zero in 500V steps spaced 10 sec apart and then waiting for an additional minute to allow the preamplifier filter network to discharge. The reason for this last precaution is that without a return path through the power supply, neither the filter capacitors nor the input coupling capacitor will have a discharge path; it may take an hour for discharge to occur through leakage resistance alone.

The user is reminded at this point that because of the vulnerability to accidental damage, the FETs are not covered by warranty.

3.3.3 DETECTOR BIAS NETWORK

Noise due to the detector load resistor diminishes as the resistance increases, with the contribution becoming negligible above approximately 100 megohm. Unfortunately, because of leakage current in room temperature surface-barrier detectors and because this leakage current is temperature dependent (doubles for each 8°-10°C increase in temperature), there is an upper limit to the size of load resistor which can be safely used. Usually, a maximum IR drop of 10V can be tolerated. A leakage current of 1 μ A through a 10 megohm load will produce such a drop.

The TC 171 is shipped with two resistors totaling 110 megohm as the detector load resistor. These can be reduced to 100 megohm and 10 megohm by the user. (See Section 7.3 for modification details.) If the detector load resistors supplied as standard are inappropriate, the user can install a different value. The resistor chosen should have low end-to-end

capacitance and low dielectric losses. This is important only when working with low capacitance detectors.

3.3.4 BIAS LEVEL

If a system containing a room-temperature surface-barrier detector is assembled and turned on in the absence of bias voltage, the electronic noise will be high. As the bias voltage is increased, the noise (observed as "grass" on an oscilloscope connected to the output of the main amplifier) should drop sharply. As the voltage is increased further, the noise should continue to drop up to the point where rated detector voltage is reached, then it should increase again. However, the appearance of this noise at this bias level will not be clean "grass" as observed earlier, but as a series of discontinuities on the baseline. This later appearance is characteristic of avalanche breakdown in the detector. The correct operating voltage for the detector is about 10% below this avalanche level. If the load resistor is too high for the leakage current of the detector, the noise level will not drop as the bias voltage is increased until it exceeds the IR drop in the load resistor. In extreme cases, this will not occur until the bias voltage as indicated on the power supply exceeds the detector manufacturer's specified maximum.

CAUTION: The user is encouraged to discuss the detector breakdown characteristics with the manufacturer of the detector. TENNELEC cannot assume responsibility for damage to the detector caused by improper load-resistor selection or by improper application of detector bias voltage. With some detectors, permanent damage will result from over-voltage.

With time and radiation damage, the onset of avalanche noise (also known as "flicker" noise) may drop to a level below the ratings of the detector, requiring a reduction of operating voltage for acceptable energy resolution (or background count rate).

4.0 ADJUSTMENTS

4.1 DC OFFSET VOLTAGE

The TC 170/TC 171 have adjustments for the DC offset voltage as measured at the energy output. The DC offset adjustment of the TC 170 is accessible through a hole in the preamplifier case as shown in Figure 4.1. This hole is normally covered with a press fit plug to reduce electrical pickup. The DC offset potentiometer is R7 as shown on the TC 170 schematic at the end of this manual. This adjustment effects the drain current of the input FET (Q1) and therefore the noise performance. To ensure the optimum noise performance, the DC offset should be adjusted for -100 mV of offset voltage as measured at the energy output connector. This measurement is made with the energy output connector unterminated. The timing output connector termination does not effect this measurement. The DC offset voltage of the TC 170 was adjusted to -100mV (± 50 mV) before leaving the factory and should not require further adjustment unless the input FET is changed.

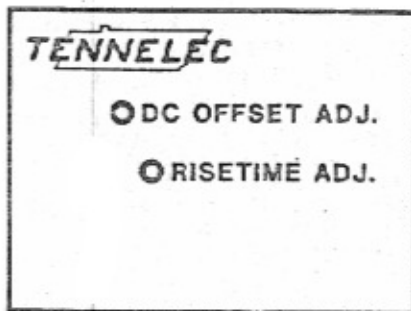

Figure 4.1 TC 170 Adjustment Locations

The TC 171 DC offset adjustment is accessible through a hole in the preamplifier case as shown in Figure 4.2. This hole is normally covered with a press fit plug to reduce electrical pickup. The DC offset potentiometer is R37 as shown on the TC 171 schematic at the end of this manual. This adjustment does not affect the FET drain current or the noise performance. To reduce

heating effects of the output stage due to DC offset voltage, the DC offset should be adjusted to zero (0) ± 100 mV as measured at the energy output connector unterminated. The timing output connector termination does not effect this measurement. The DC offset voltage was adjusted to zero before leaving the factory and should not require further adjustment unless the input FET's are changed.

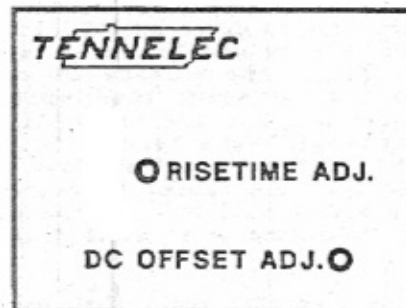

Figure 4.2 TC 171 Adjustment Locations

4.2

RISE TIME

The TC 170/TC 171 have risetime adjustments as shown in Figures 4.1 and 4.2. The risetime adjustment corresponds to R11 on the TC 170 schematic and R9 on the TC 171 schematic at the end of this manual. To obtain optimum transient response and timing performance, the risetime adjustment must be set with the detector (or an equivalent detector capacitance) and any connecting cable connected to the preamplifier input, with bias applied (if an equivalent detector capacitance is used in place of the detector, no high voltage bias is necessary). When minimum risetime is obtained, a short period overshoot of 10% to 20% will be observed. This overshoot has no effect on noise performance or linearity within the normal dynamic range. Additionally, the overshoot will have no adverse affect on timing measurements. Further improvement in timing performance can be obtained by adjusting the risetime control for a shorter risetime and more overshoot. The increased overshoot will be accompanied by some ringing which limits the minimum risetime.

Some ringing can be tolerated if the discriminator has an adjustable deadtime control.

NOTE: Detector inductance has a very important bearing on preamplifier signal risetime and circuit stability. It is essential when operating the preamplifier for the first time to match it to detector characteristics. To do this, connect a fast oscilloscope to the output of the preamplifier and excite the detector with a weak radiation source that generates only one spectral line. ²¹⁰Po is a good source for this purpose with room temperature silicon detectors. The oscilloscope should have a bandwidth of 250 MHz or more, and should be triggered internally. A continuously changing ensemble of randomly occurring pulses will be seen, making observation of the pulse difficult. Unfortunately, not much can be done about this.

The adjustment is made by turning the risetime control to obtain the optimum balance between ringing and risetime.

Depending on the equivalent circuit of the detector, some settings may cause oscillation. This is normal. A stubborn case of oscillation indicates excessive detector inductance or connecting cable length.

If the oscillation is difficult to eliminate, or elimination results in slower than expected risetime, it is recommended that the connecting cable be reduced to as short as practical. If this does not eliminate the oscillation, the built-in series resistor R9 can be added to the circuit by removing jumper J1 located at the input connector. If the original value of 22 ohms is inadequate, it may be increased at the expense of risetime and noise performance. The TC 170 normally will be stable with up to 3 feet of cable between detector and preamplifier, and up to 2 feet with the TC 171.

Typical risetime versus detector capacitance is given in Section 2.1. Due to the fast risetimes of the TC 170/TC 171, it is recommended that a pulser and oscilloscope with 1 nsec or less risetime be used to check and adjust the transient response when not using a detector and source. The actual preamplifier risetime (t_{rpa}) is

$$t_{rpa} = (t_{ra}^2 - t_{rb}^2)^{1/2}$$

where t_{ra} is the risetime of the preamplifier, pulser and oscilloscope, and t_{rb} is the risetime of the pulser and oscilloscope only. By using the equation given above, the risetime contributions of the pulser and oscilloscope can be removed. All risetime specifications apply when the timing output is terminated in its characteristic impedance (50 ohms) and is independent of the energy output termination (no load or 50 ohms).

5.0

NOISE

5.1

NOISE PERFORMANCE

To convert from full width-at-half-maximum (FWHM) Si to a different reference, use Table 1.

TABLE 1

CONVERSION OF FWHM Si TO OTHER REFERENCE VALUES

Reference	Multiply eV FWHM Si by:
FWHM Si	1.00 (W=3.6 eV/electron-hole pair)
FWHM Ge	0.819 (W=2.95 eV/electron-hole pair)
FWHM P10	6.94 (W=25 eV/electron-hole pair)
Ion pairs rms	0.144
Coulombs rms	2.3×10^{-20}

The noise performance of the TC 170/TC 171 for a shaping time of 2.0 usec and 0.5 usec is given in Section 2.1. The noise performance of the TC 170 and TC 171 at various shaping times and detector load resistance, with and without the protection network, is shown in Figures 5.1 thru 5.6. With the aid of this data, the noise performance of the preamplifier can be predicted for almost any combination of detector capacitance and shaping time. It is stressed that the foregoing figures are noise levels and not spectral resolution. The final spectral resolution depends not only on the preamplifier noise but also on the type of detector used, the count rate, and other factors. An additional consideration in evaluating the preamplifier noise limitations is the detector leakage current. All the previous noise data is representative of the preamplifier detector combination with zero detector leakage current.

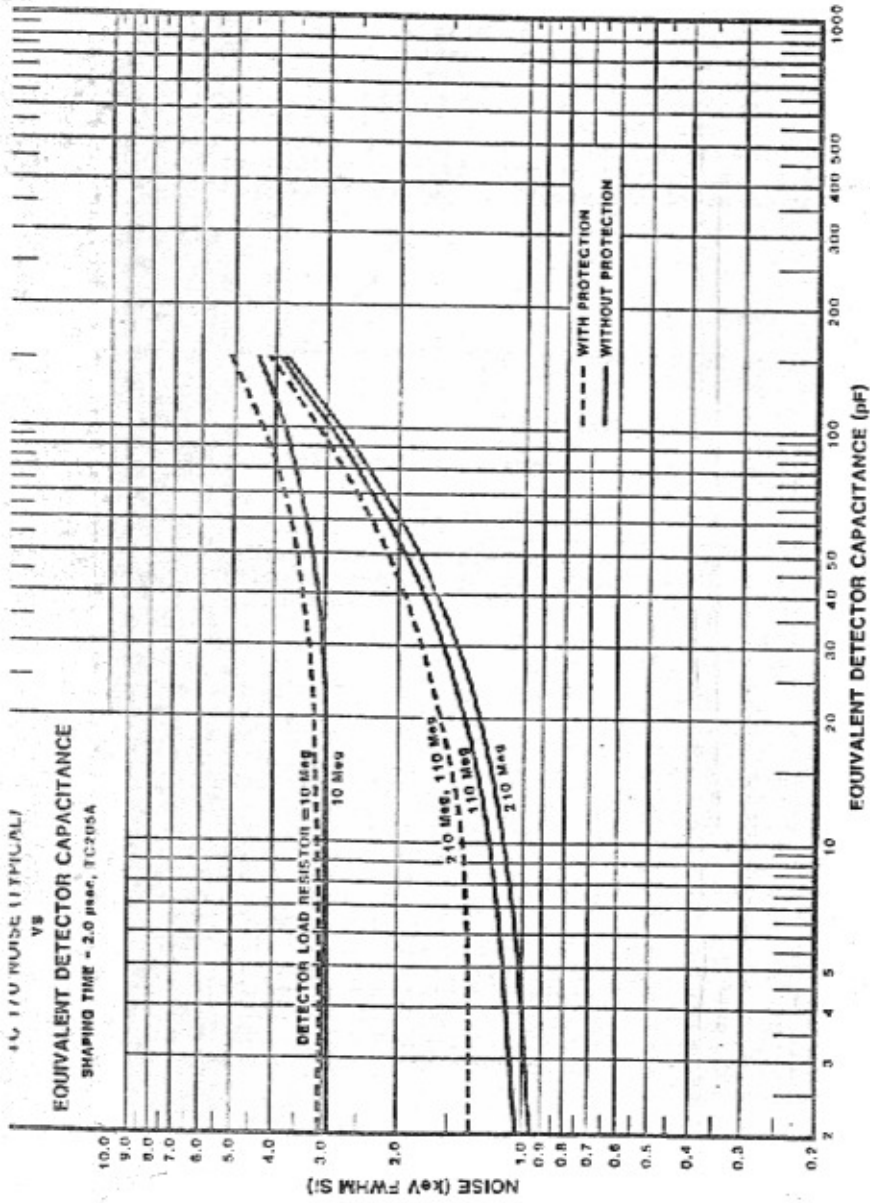

Figure 5.1 Electronic Noise vs Equivalent Detector Capacitance (TC 170, 2.0 usec Shaping Time)

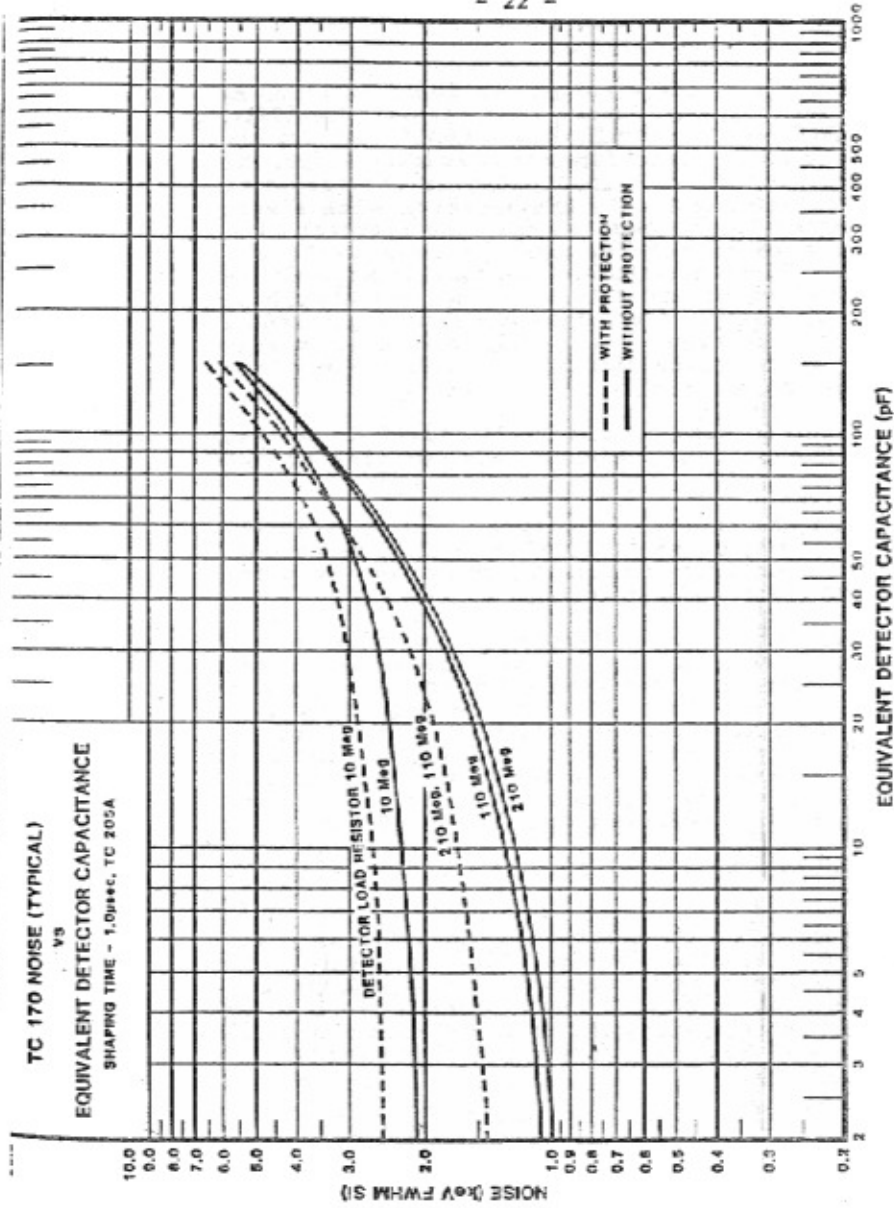

Figure 5.2 Electronic Noise vs Equivalent Detector Capacitance (TC 170, 1.0 usec Shaping Time)

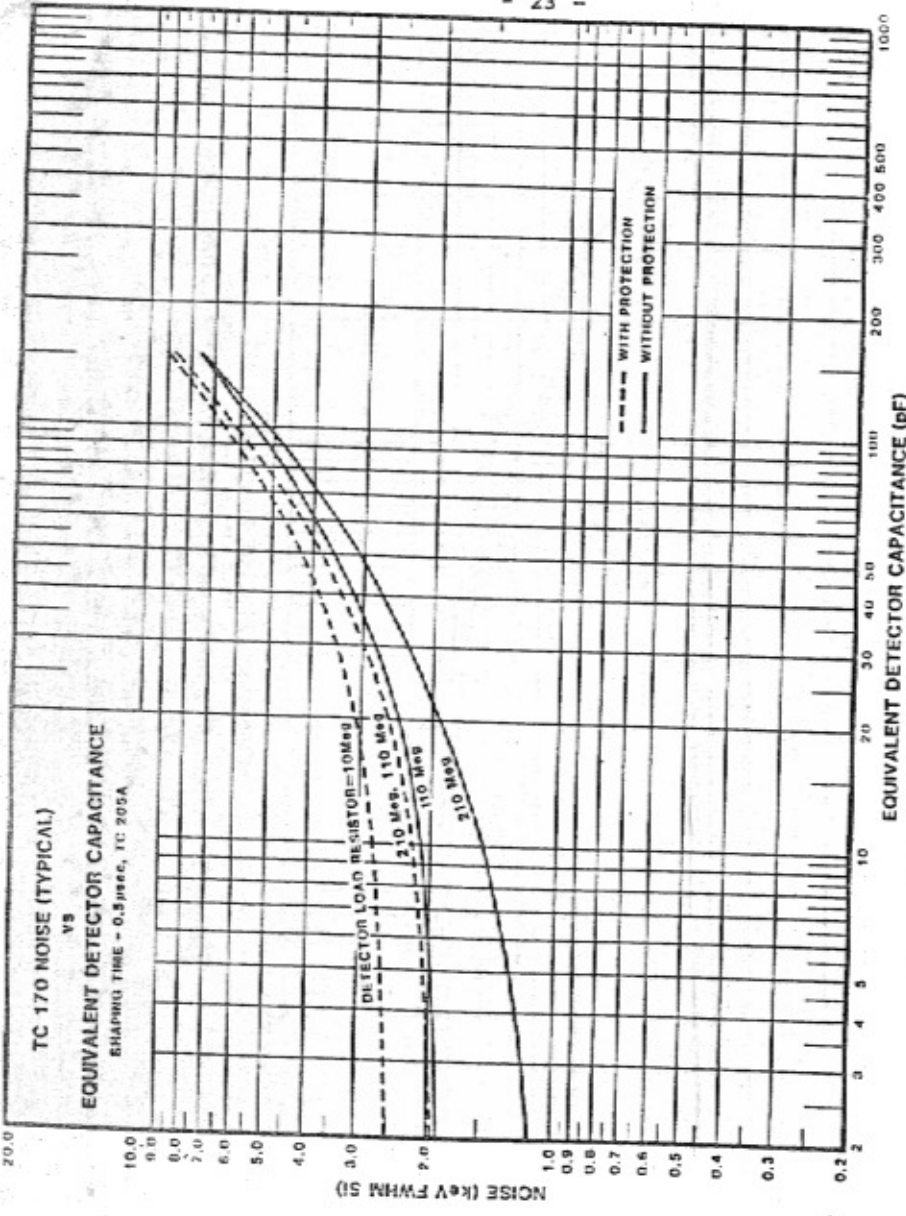

Figure 5.3 Electronic Noise vs Equivalent Detector Capacitance
 (TC 170, 0.5 usec Shaping Time)

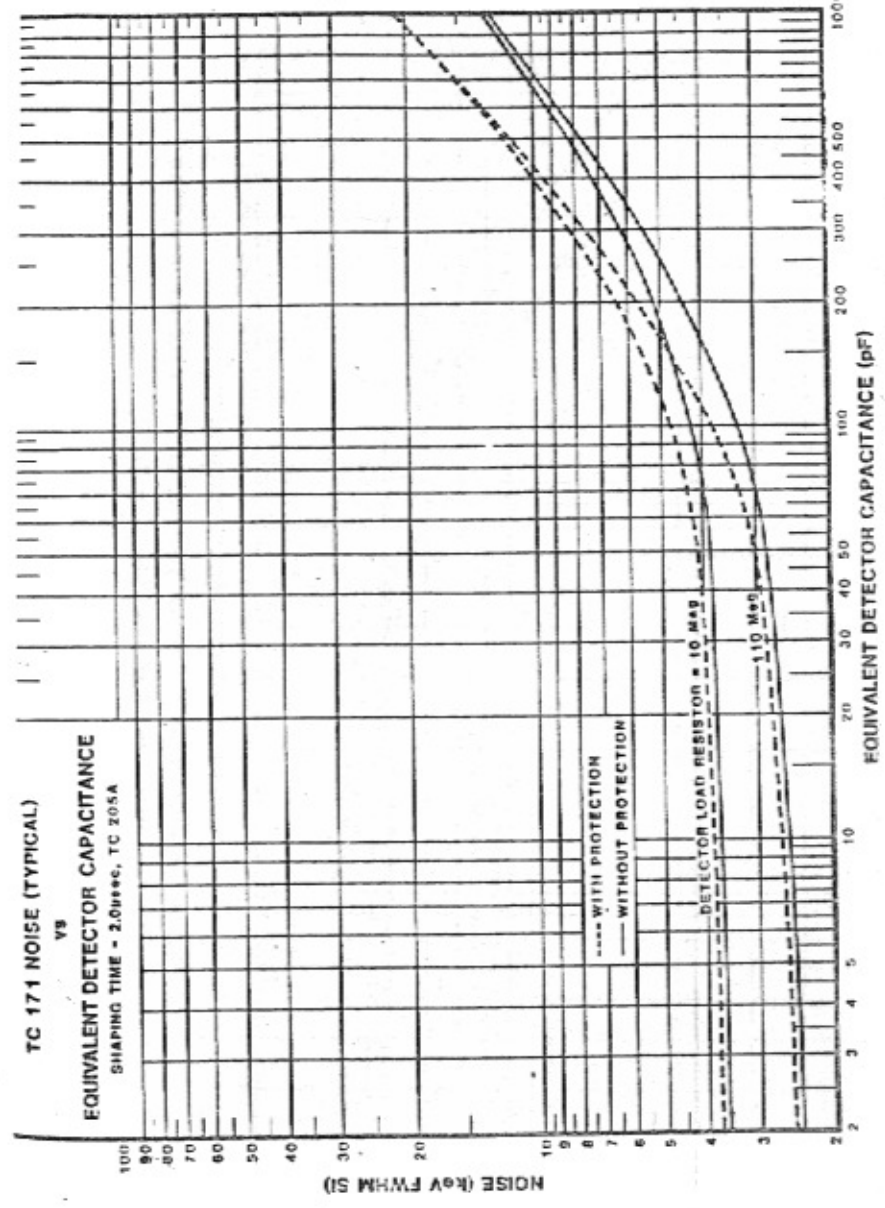

Figure 5.4 Electronic Noise vs Equivalent Detector Capacitance
 (TC 171, 2.0 usec Shaping Time)

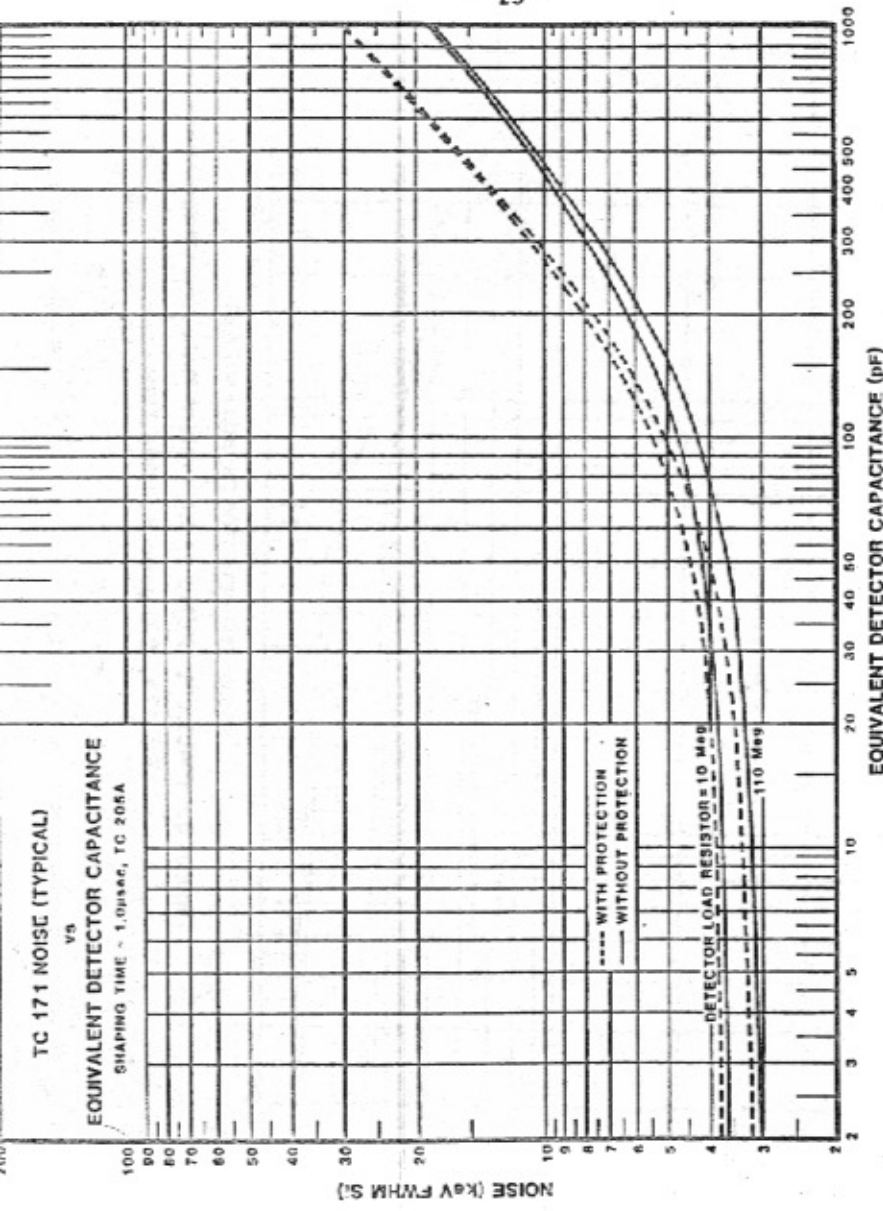

Figure 5.5 Electronic Noise vs Equivalent Detector Capacitance
(TC 171, 1.0 usec Shaping Time)

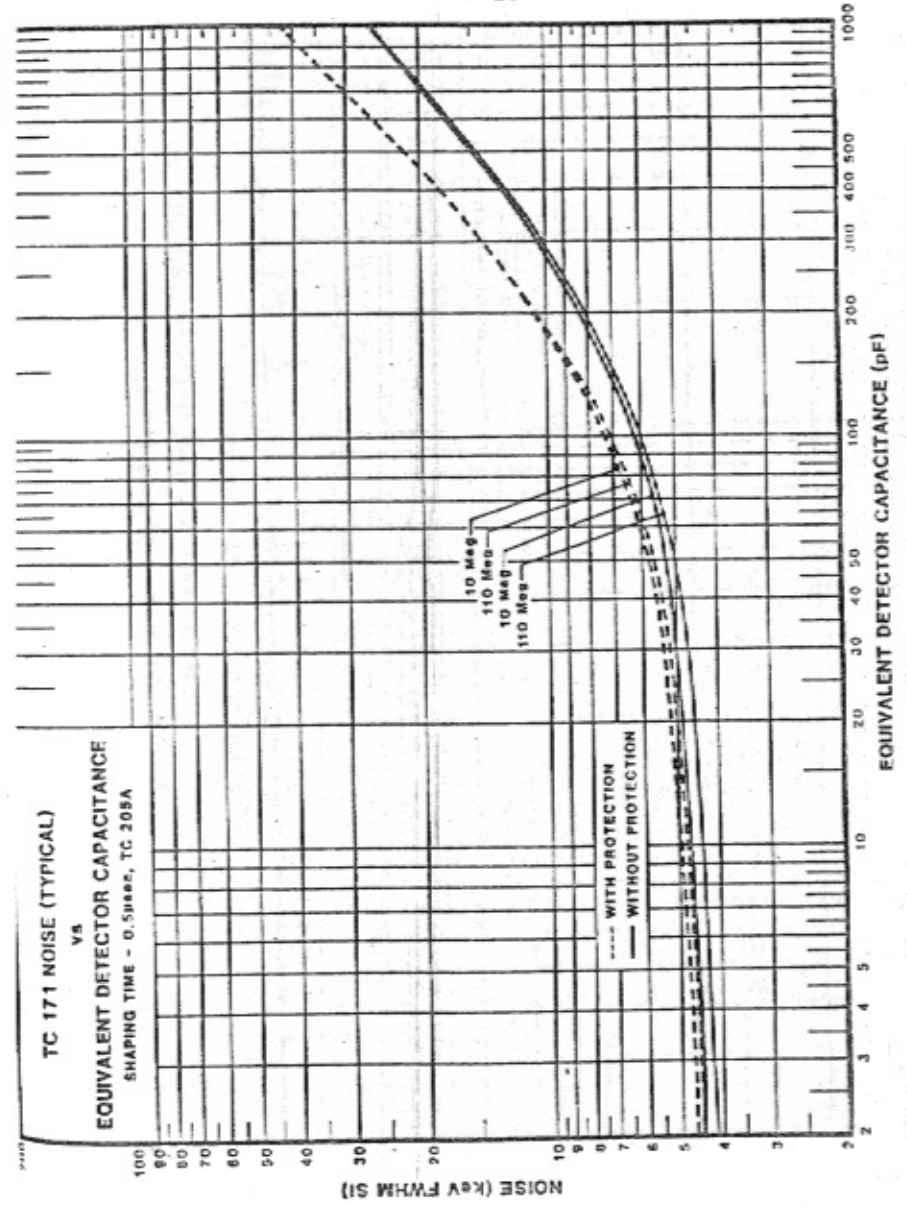

Figure 5.6 Electronic Noise vs Equivalent Detector Capacitance
(TC 171, 0.5 usec Shaping Time)

5.2

NOISE MEASUREMENTS

To verify the proper operation of the preamplifier, noise measurements can be made by either of two methods. These measurements can be compared with the values given in Section 2.1 and Figure 5.1 thru 5.6.

One method requires a calibrated step-generator (e.g. TENNELEC TC 812), a shaping main-amplifier (TC 205A, TC 222, TC 240, or TC 241), and a multichannel pulse height analyzer. After the shaping time constant has been chosen and the analyzer has been calibrated in terms of energy per channel, pulses are fed through the test capacitor; the line width recorded by the analyzer is measured. For this test, as for any measurement of absolute noise of the preamplifier, the detector should be replaced by a dummy capacitor of the same capacitance. The full-width-at-half-maximum of the line should be close to the values given in Section 2.1 for typical performance and the typical data given in Figures 5.1 thru 5.6. If the noise at 2.0 usec exceeds the guaranteed values given in Section 2.1, verify that the protection network is not in and that the correct detector load resistor is installed.

The second method requires the use of a calibrated pulse generator, a shaping main-amplifier, an average-type ac voltmeter (such as a Hewlett-Packard 400D, 400E, or 400L) or a true rms voltmeter (such as a Hewlett-Packard 3400A), and a calibrated oscilloscope. A step of known amplitude V_i is applied to the input through the test capacitor C_T , resulting in a charge transfer to the input of $V_i \times C_T$ coulombs. The resulting main-amplifier pulse height V_o is recorded with the oscilloscope. The pulse generator is then turned off, and the true rms noise level V_n is measured at the output of the main amplifier. If a true rms voltmeter is used, the reading is directly V_n . If an average-type voltmeter is used, the reading V_r should be multiplied by the factor 1.135 to obtain V_n . The level in keV FWHM referred to Si detectors is given by

$$\text{Noise (FWHM)} = \frac{V_n \times V_i \times C_T}{V_o} \times 5.298 \times 10^{16}$$

where 5.298×10^{16} is a factor that contains the charge of an electron in coulombs, the energy necessary to produce one electron-hole pair in silicon, and the

conversion constant between rms and FWHM. For detectors other than silicon, choose the appropriate multiplier from Table 1.

If a problem with excessive noise should occur, either of the two procedures described should be used to evaluate the noise performance. The preamplifier noise performance can be verified by replacing the detector with a suitable capacitor having the same capacitance value as the detector. If this noise is within specifications at 2.0 usec shaping time, or similar to data given in section 5.1, the problem is associated with the detector. The total noise of the system is given by

$$N_{\text{total}} = [(N_{\text{preamplifier}})^2 + (N_{\text{detector}})^2]^{1/2}$$

Using the above equation and the noise of the preamplifier (as previously determined) the noise of the detector can be calculated and compared with the manufacturer's data.

6.0

COUNT RATE EFFECTS

6.1

RESOLUTION

The shape of a typical spectral line is Gaussian and is shown in Figure 6.1.

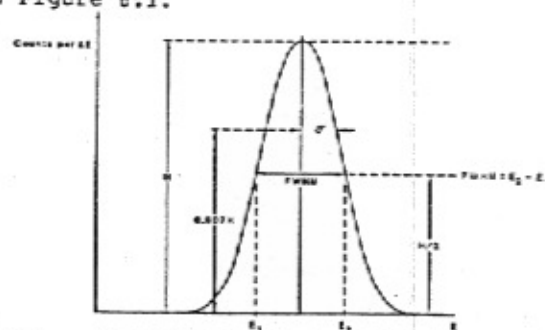

Figure 6.1. The shape of a typical spectral line (Gaussian).

The resolution, or ability of a nuclear spectrometer to separate different radiation energies, is usually expressed in terms of the full width of the spectral lines measured at half their maximum height. This

quantity is denoted by the letters FWHM and is given in units of energy. The FWHM is 2.35σ where σ is the standard deviation. If noise alone controls the resolution, then σ and the rms noise level are synonymous. We have been using FWHM to characterize preamplifier noise levels in the previous section.

The resolution obtained in any particular spectral measurement is the result of several factors: preamplifier noise, detector characteristics, count rate, radiation energy, overall system stability, proper interfacing between instruments within the system, etc. In an experimental situation in which the count rate is low enough so that the pulse shape can be adjusted for the best signal-to-noise ratio without being affected by pile-up or baseline shift but high enough so that effects due to long term drifts can be neglected, the resolution will be determined by three factors: (a) detector resolution for the particular radiation energy being observed, (b) electronic noise, and (c) interfacing. Furthermore, if it is assumed that the different components of the system are properly matched, the line-width is a function of only the detector resolution and the electronic noise. The three magnitudes are, then, related in the following way:

$$R^2 = (\text{Total Resolution})^2 = (\text{Detector Resolution})^2 + (\text{Electronic Noise})^2$$

We shall call R the intrinsic resolution of the system. In a counting situation in which the conditions are not ideal, the measured resolution will be worse than the intrinsic resolution. Usually, the main factor in line-width broadening is count rate. Count rate can have a deleterious effect in spectral resolution through several mechanisms. The three most commonly found are pile-up of pulses, baseline shifts, and thermal effects in components. The last two can usually be neglected in properly designed systems; the first one is more difficult to contend with.

Usually, pile-up of shaped pulses in the main amplifier will set the practical upper count rate limit. However, at very high energy (lowest gain settings of the main amplifier), the limitation may occur in the preamplifier. A discussion of preamplifier pile-up follows, plus the technique of computing the upper count rate limit.

The pulse obtained at the output of the preamplifier appears as shown in Figure 6.2.

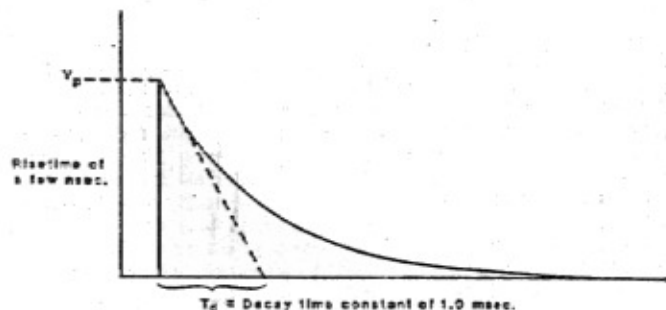

Figure 6.2 Pulse shape at the output of a preamplifier.

When pulses come in rapid succession, the wave form at the output of the preamplifier appears as shown in Figure 6.3. The dotted line at the top of Figure 6.3 indicates the limit of the linear range of the preamplifier.

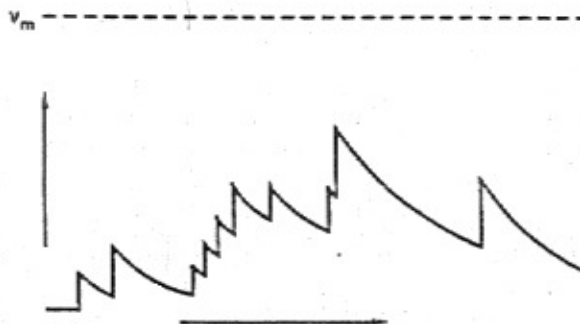

Figure 6.3 The Waveform at the Output of a Preamplifier with Pulses Applied to the Input in Rapid Succession

If the count rate is high enough, some of the pulses will rise beyond the linear range and therefore, their amplitudes will be distorted. (The meaning of "linearity" is explained in Section 6.1.) If we assume 1CV to be the limit of the linear range, the preamplifier sensitivity to be 44 mV/MeV, the average radiation energy to be 2.5 MeV, and the decay time constant to be 1 msec, we can compute the count rate that will be necessary to make 5% of the pulses fall beyond the linear range from the formula

$$\text{Where } n = 2 \left[\frac{V_m - E_\alpha G_c}{T_d \cdot 2.5 E_\alpha G_c} \right]^2$$

- n = count rate in cps.
- T_d = decay time constant in sec.
- V_m = linear range in volts.
- E_α = radiation energy in MeV.
- G_c = preamplifier sensitivity in V/MeV.

Replacing symbols by actual numbers
 n = 2.58 x 10⁶ cps.

Since the TC 170/TC 171 are ac-coupled preamplifiers, a count-rate product cannot be assigned with any useful units as the number would apply only for one specific energy. The maximum count rate at 1MeV and 10MeV of the TC 170/TC 171 are given in Section 2.1.

6.2

NONLINEARITY

If a graph of output signal level V_o vs. input pulse height V_i (dynamic characteristic) is drawn, a perfectly straight line passing through the origin should result. In practice, the dynamic characteristic could have a slight curvature up to a certain signal level, beyond which the curvature increases drastically. The onset of this drastic change is usually considered to be the upper limit of the normal dynamic range (rated output).

Integral nonlinearity is defined as the maximum deviation of the measured preamplifier response from the ideal response, expressed as a percentage of the rated output (as described in the preceding paragraph). This definition is useful only for isolated preamplifier pulses as shown in Figure 6.2. When

pileup occurs as the result of an ensemble of closely spaced small pulses (Figure 6.3), we are interested not only in the integral nonlinearity but also in the deviation of height of individual steps (within the "linear" range of the preamplifier) from the expected height. This incremental deviation in ΔV_o/ΔV_i from the value at zero volts on the dynamic characteristic is described as the differential nonlinearity. It is this definition which is used in the table of specifications.

PREAMPLIFIER MODIFICATIONS

TENNELEC representatives will help users with information about preamplifier modification. The representative will require details of the desired modification, serial number of the preamplifier, type of detector with which it will be used, approximate detector capacitance and operating voltage, and type and energy of the radiation being measured.

UNLESS THE USER IS ADEPT AT MAKING MODIFICATIONS OF THIS SORT, IT IS STRONGLY RECOMMENDED THAT THE MODIFICATIONS BE PERFORMED AT THE TENNELEC PLANT.

REMOVING THE CASE

Remove the two press fit plugs, remove the four mounting screws on the bottom of the case, and carefully remove the preamp from the case.

CHANGING PREAMPLIFIER SENSITIVITY

Reducing the preamplifier sensitivity will almost certainly cause it to oscillate unless the stabilization networks are changed as well. For this change the user is requested to return the instrument to TENNELEC for modification. Increasing the sensitivity will not cause oscillation, but may degrade the risetime and pulse shape. Again, the user is requested to return the instrument to TENNELEC for modification.

FRONT-END MODIFICATIONS

The TC 170 is supplied with two 100 megohm resistors and one 10M ohm resistor in series to function as a detector load resistor for low leakage room temperature silicon detectors. When bias voltage is applied, a

voltage drop will be developed across these resistors due to the detector leakage current. If this voltage drop becomes significant, it should be reduced by removing one or both of the 100 megohm resistors from the bias circuit. Physically removing the resistors is not recommended. However, these resistors can be electrically removed by soldering a wire across the resistor from standoff to standoff.

The TC 171 is supplied with one 100 megohm resistor and one 10 megohm resistor in series to function as a detector load resistor. The voltage drop across the load resistors must be taken into consideration as for the TC 170. Note that reducing the load resistor will raise the preamplifier noise slightly at very low capacitance, however, this increase will tend to be minor due to the noise from the leakage current of the detector. For larger detectors (50 pF and above), the increase in noise will be further masked by the dominance of the series noise of the preamplifier.

NOTE: If the preamplifier will be used with more than 1kV applied to the detector terminal, it is very important that all solder joints in the high voltage chain be smooth-surfaced and with no sharp points protruding. Furthermore, it is important that all capacitors and high megohm resistors used in this part of the circuit be free of surface contamination. Components that are contaminated can cause increases in preamplifier noise, leakage current, noise spikes from arcing, etc. In particular, the feedback resistor and the 100 megohm load resistors are very fragile and should not be touched with a hot soldering iron, sharp-pointed tool or bare fingers (body oil may increase the leakage significantly across these resistors). Similar precautions should be taken when working with the feedback capacitor, the test capacitor, the input coupling capacitor, the FET heatsink, and the Teflon standoffs. These components can be safely cleaned with methanol using a camel hair brush or a clean cotton swab.

7.4

MODIFICATION OF FET DRAIN CURRENT

The FET drain current of the TC 170 can be adjusted by changing R7. However, this will affect the dc offset, which should never be set to less than -50mV dc. The normal dc offset voltage is -100mV, which is close to the value resulting from operation of the input FET at I_{dss} . Best noise performance is obtained at or near the I_{dss} level.

The FET drain current of the TC 171 is set by R6 at approximately 40ma. The drain current can be lowered with a resultant increase in noise, if power consumption is a major consideration. If the drain current is changed, the dc offset voltage must be readjusted to zero \pm 100mV using R37.

1.0

SHIPPING DAMAGE

Upon receipt of the instrument, examine it for shipping damage. Damage claims should be filed with the carrier. The claims agent should receive a full report; a copy of that report should be sent to TENNELEC, Inc., P.O. Box D, Oak Ridge, Tennessee 37830. The model number and serial number of the instrument must be included in the report. Any remedial action taken by TENNELEC, Inc. will be based on the information contained in this report.

.0

SERVICING

In the event of a component failure, replacement may be done in the field or the instrument may be returned to our plant for repair. There will be no charge for repairs that fall within the warranty.

0.0

WARRANTY

In connection with TENNELEC's warranty (inside front cover), TENNELEC suggests that if a fault develops, the customer should immediately notify the TENNELEC Customer Service Manager. The Customer Service Manager may be able to prescribe repairs and to send replacement parts which will enable you to get the instrument operating sooner and at less expense than if you returned it. Additionally, due to the susceptibility of input FET's to damage when operated without the protection network installed, these devices are not covered under the warranty.

Should return prove necessary, the TENNELEC Customer Service Manager must be informed in WRITING, BY CABLE or TWX of the nature of the fault and the model number and serial number of the instrument. Pack the instrument well and ship PREPAID and INSURED to TENNELEC, Inc., 601 Oak Ridge Turnpike, Oak Ridge, Tennessee 37830. As stated in the warranty DAMAGE IN TRANSIT WILL BE REPAIRED AT THE SENDER'S EXPENSE as will damage that obviously resulted from abuse or misuse of the instrument.

Quotations for repair of such damage will be sent for your approval before repair is undertaken.

 * TENNELEC's Quality Assurance Program requires *
 * that each and every instrument be fully aged, *
 * vibrated, and electronically checked. *
 *
 * Should the user require a copy of the Quality *
 * Control Procedure and Test Record, please call *
 * the Customer Service Department of TENNELEC. *
 * Both model number and serial numbers are *
 * required. *
 * *****

MANUAL REV. 2

1/88 - Engineering and component improvements may be made after date of printing.

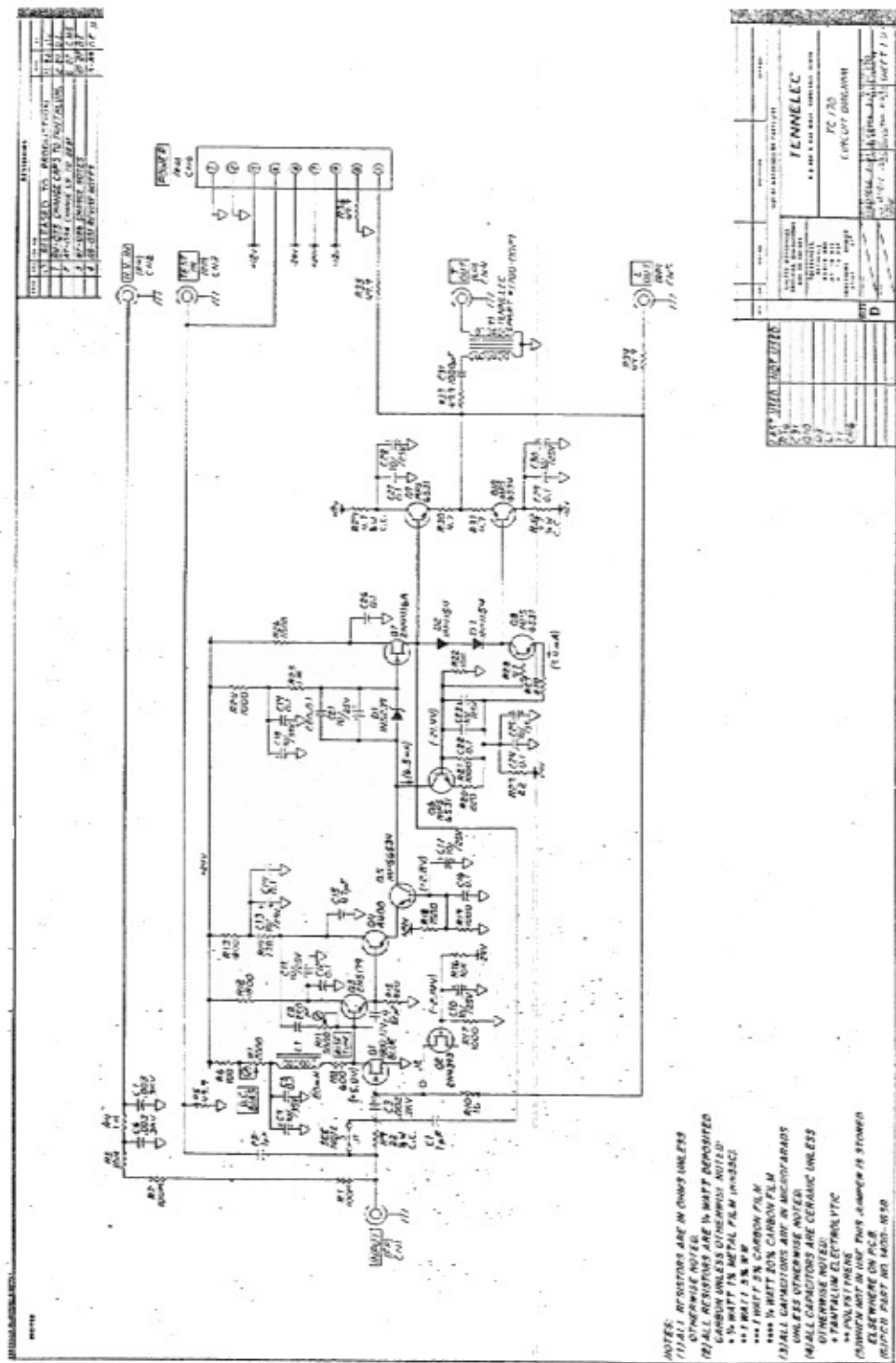

REVISIONS

NO.	DATE	BY	DESCRIPTION
1			FOR REFERENCE TO MANUFACTURING
2			FOR USE MANUFACTURING AND INSPECTION
3			FOR USE MANUFACTURING AND INSPECTION
4			FOR USE MANUFACTURING AND INSPECTION

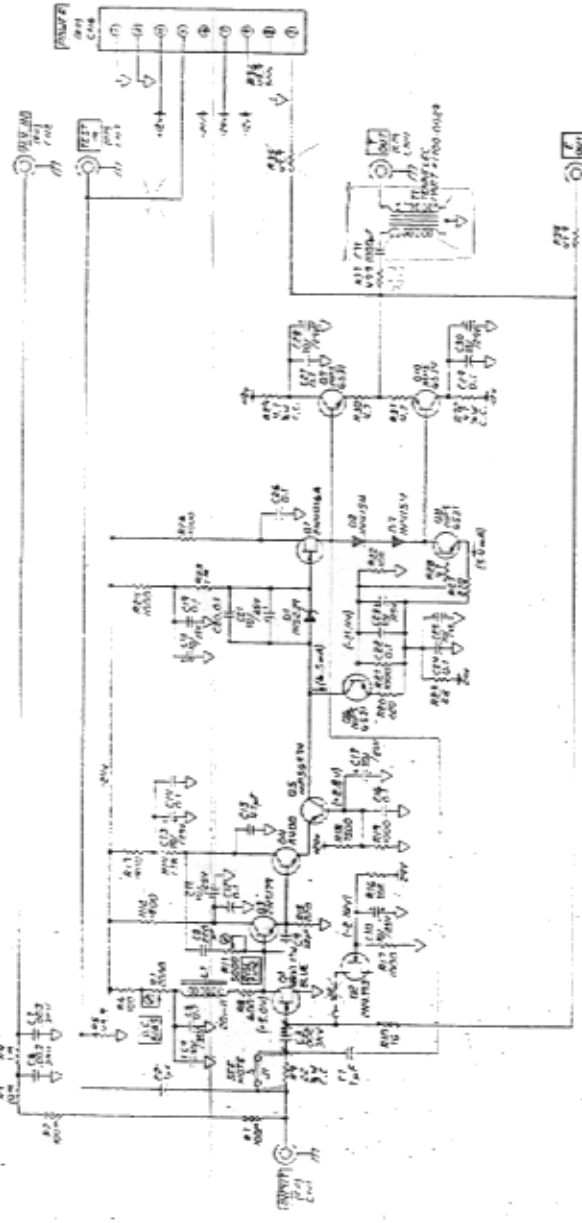

NOTE:
 (1) ALL RESISTORS ARE IN OHMS UNLESS
 INDICATED OTHERWISE.
 (2) ALL RESISTORS ARE IN MFT UNLESS
 OTHERWISE NOTED.
 (3) ALL CAPACITORS ARE IN MICROFARADS
 UNLESS OTHERWISE NOTED.
 (4) ALL CAPACITORS ARE CERAMIC UNLESS
 OTHERWISE NOTED.
 (5) TRANSISTORS ARE 2Nxxxxx TYPE
 UNLESS OTHERWISE NOTED.
 (6) UNLESS OTHERWISE NOTED,
 DIMENSIONS ARE IN INCHES.
 (7) DIMENSIONS ARE IN MILLIMETERS
 UNLESS OTHERWISE NOTED.

PARTS LIST		
Q1, Q2, Q3, Q4, Q5, Q6, Q7, Q8, Q9, Q10, Q11, Q12, Q13, Q14, Q15, Q16, Q17, Q18, Q19, Q20, Q21, Q22, Q23, Q24, Q25, Q26, Q27, Q28, Q29, Q30, Q31, Q32, Q33, Q34, Q35, Q36, Q37, Q38, Q39, Q40, Q41, Q42, Q43, Q44, Q45, Q46, Q47, Q48, Q49, Q50, Q51, Q52, Q53, Q54, Q55, Q56, Q57, Q58, Q59, Q60, Q61, Q62, Q63, Q64, Q65, Q66, Q67, Q68, Q69, Q70, Q71, Q72, Q73, Q74, Q75, Q76, Q77, Q78, Q79, Q80, Q81, Q82, Q83, Q84, Q85, Q86, Q87, Q88, Q89, Q90, Q91, Q92, Q93, Q94, Q95, Q96, Q97, Q98, Q99, Q100	Q100	
T1		
R1, R2, R3, R4, R5, R6, R7, R8, R9, R10, R11, R12, R13, R14, R15, R16, R17, R18, R19, R20, R21, R22, R23, R24, R25, R26, R27, R28, R29, R30, R31, R32, R33, R34, R35, R36, R37, R38, R39, R40, R41, R42, R43, R44, R45, R46, R47, R48, R49, R50, R51, R52, R53, R54, R55, R56, R57, R58, R59, R60, R61, R62, R63, R64, R65, R66, R67, R68, R69, R70, R71, R72, R73, R74, R75, R76, R77, R78, R79, R80, R81, R82, R83, R84, R85, R86, R87, R88, R89, R90, R91, R92, R93, R94, R95, R96, R97, R98, R99, R100		R100
C1, C2, C3, C4, C5, C6, C7, C8, C9, C10, C11, C12, C13, C14, C15, C16, C17, C18, C19, C20, C21, C22, C23, C24, C25, C26, C27, C28, C29, C30, C31, C32, C33, C34, C35, C36, C37, C38, C39, C40, C41, C42, C43, C44, C45, C46, C47, C48, C49, C50, C51, C52, C53, C54, C55, C56, C57, C58, C59, C60, C61, C62, C63, C64, C65, C66, C67, C68, C69, C70, C71, C72, C73, C74, C75, C76, C77, C78, C79, C80, C81, C82, C83, C84, C85, C86, C87, C88, C89, C90, C91, C92, C93, C94, C95, C96, C97, C98, C99, C100		C100
D1, D2, D3, D4, D5, D6, D7, D8, D9, D10, D11, D12, D13, D14, D15, D16, D17, D18, D19, D20, D21, D22, D23, D24, D25, D26, D27, D28, D29, D30, D31, D32, D33, D34, D35, D36, D37, D38, D39, D40, D41, D42, D43, D44, D45, D46, D47, D48, D49, D50, D51, D52, D53, D54, D55, D56, D57, D58, D59, D60, D61, D62, D63, D64, D65, D66, D67, D68, D69, D70, D71, D72, D73, D74, D75, D76, D77, D78, D79, D80, D81, D82, D83, D84, D85, D86, D87, D88, D89, D90, D91, D92, D93, D94, D95, D96, D97, D98, D99, D100		D100
U1, U2, U3, U4, U5, U6, U7, U8, U9, U10, U11, U12, U13, U14, U15, U16, U17, U18, U19, U20, U21, U22, U23, U24, U25, U26, U27, U28, U29, U30, U31, U32, U33, U34, U35, U36, U37, U38, U39, U40, U41, U42, U43, U44, U45, U46, U47, U48, U49, U50, U51, U52, U53, U54, U55, U56, U57, U58, U59, U60, U61, U62, U63, U64, U65, U66, U67, U68, U69, U70, U71, U72, U73, U74, U75, U76, U77, U78, U79, U80, U81, U82, U83, U84, U85, U86, U87, U88, U89, U90, U91, U92, U93, U94, U95, U96, U97, U98, U99, U100		U100
T1		
J1		

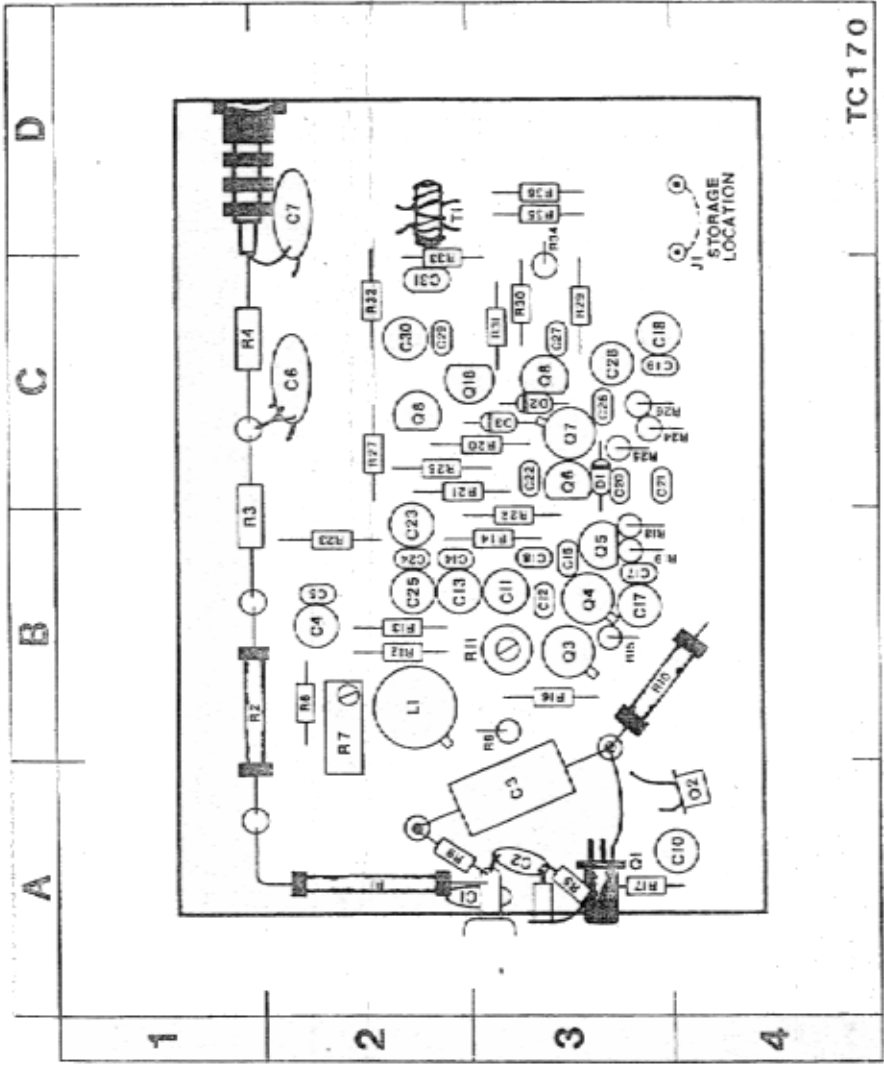

TC170

REV	DATE	BY	CHK
1	10/1/68	J. J. ...	J. J. ...
2	10/1/68	J. J. ...	J. J. ...
3	10/1/68	J. J. ...	J. J. ...
4	10/1/68	J. J. ...	J. J. ...
5	10/1/68	J. J. ...	J. J. ...

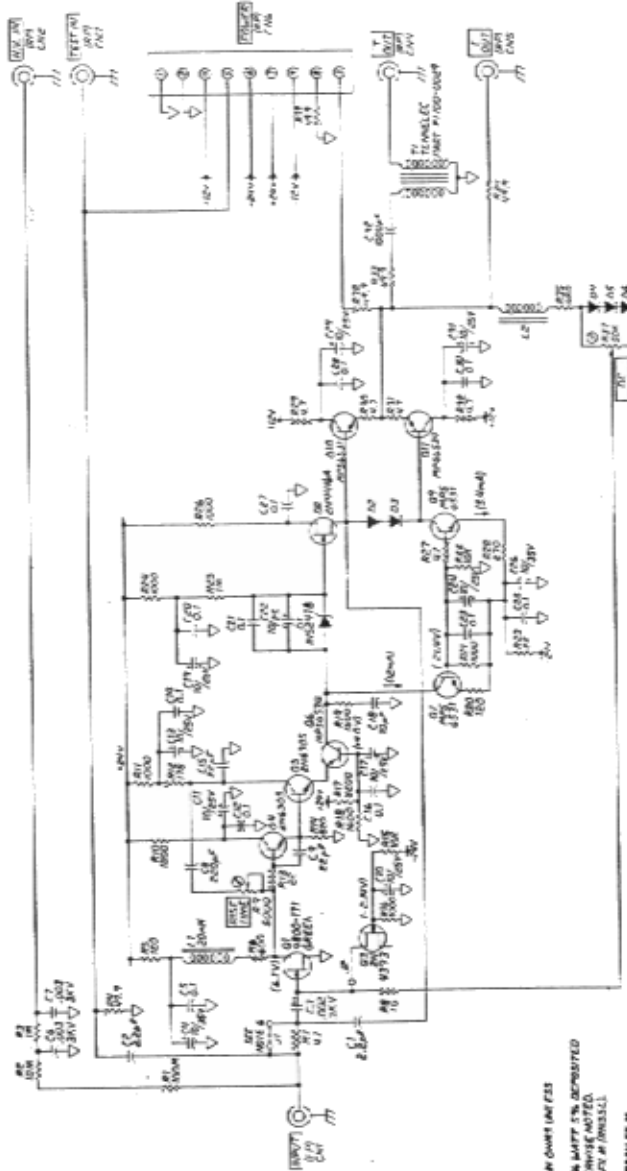

REV	DATE	BY	CHK
1	10/1/68	J. J. ...	J. J. ...
2	10/1/68	J. J. ...	J. J. ...
3	10/1/68	J. J. ...	J. J. ...
4	10/1/68	J. J. ...	J. J. ...
5	10/1/68	J. J. ...	J. J. ...

- NOTES:
- (1) ALL RESISTORS ARE IN OHMS UNLESS OTHERWISE NOTED.
 - (2) ALL CAPACITORS ARE IN MFDT UNLESS OTHERWISE NOTED.
 - (3) ALL CAPACITORS ARE IN MFDT UNLESS OTHERWISE NOTED.
 - (4) ALL CAPACITORS ARE IN MFDT UNLESS OTHERWISE NOTED.
 - (5) ALL CAPACITORS ARE IN MFDT UNLESS OTHERWISE NOTED.
 - (6) ALL CAPACITORS ARE IN MFDT UNLESS OTHERWISE NOTED.
 - (7) ALL CAPACITORS ARE IN MFDT UNLESS OTHERWISE NOTED.
 - (8) ALL CAPACITORS ARE IN MFDT UNLESS OTHERWISE NOTED.
 - (9) ALL CAPACITORS ARE IN MFDT UNLESS OTHERWISE NOTED.
 - (10) ALL CAPACITORS ARE IN MFDT UNLESS OTHERWISE NOTED.
 - (11) ALL CAPACITORS ARE IN MFDT UNLESS OTHERWISE NOTED.
 - (12) ALL CAPACITORS ARE IN MFDT UNLESS OTHERWISE NOTED.
 - (13) ALL CAPACITORS ARE IN MFDT UNLESS OTHERWISE NOTED.
 - (14) ALL CAPACITORS ARE IN MFDT UNLESS OTHERWISE NOTED.
 - (15) ALL CAPACITORS ARE IN MFDT UNLESS OTHERWISE NOTED.
 - (16) ALL CAPACITORS ARE IN MFDT UNLESS OTHERWISE NOTED.
 - (17) ALL CAPACITORS ARE IN MFDT UNLESS OTHERWISE NOTED.
 - (18) ALL CAPACITORS ARE IN MFDT UNLESS OTHERWISE NOTED.
 - (19) ALL CAPACITORS ARE IN MFDT UNLESS OTHERWISE NOTED.
 - (20) ALL CAPACITORS ARE IN MFDT UNLESS OTHERWISE NOTED.
 - (21) ALL CAPACITORS ARE IN MFDT UNLESS OTHERWISE NOTED.
 - (22) ALL CAPACITORS ARE IN MFDT UNLESS OTHERWISE NOTED.
 - (23) ALL CAPACITORS ARE IN MFDT UNLESS OTHERWISE NOTED.
 - (24) ALL CAPACITORS ARE IN MFDT UNLESS OTHERWISE NOTED.
 - (25) ALL CAPACITORS ARE IN MFDT UNLESS OTHERWISE NOTED.
 - (26) ALL CAPACITORS ARE IN MFDT UNLESS OTHERWISE NOTED.
 - (27) ALL CAPACITORS ARE IN MFDT UNLESS OTHERWISE NOTED.
 - (28) ALL CAPACITORS ARE IN MFDT UNLESS OTHERWISE NOTED.
 - (29) ALL CAPACITORS ARE IN MFDT UNLESS OTHERWISE NOTED.
 - (30) ALL CAPACITORS ARE IN MFDT UNLESS OTHERWISE NOTED.
 - (31) ALL CAPACITORS ARE IN MFDT UNLESS OTHERWISE NOTED.
 - (32) ALL CAPACITORS ARE IN MFDT UNLESS OTHERWISE NOTED.
 - (33) ALL CAPACITORS ARE IN MFDT UNLESS OTHERWISE NOTED.
 - (34) ALL CAPACITORS ARE IN MFDT UNLESS OTHERWISE NOTED.
 - (35) ALL CAPACITORS ARE IN MFDT UNLESS OTHERWISE NOTED.
 - (36) ALL CAPACITORS ARE IN MFDT UNLESS OTHERWISE NOTED.
 - (37) ALL CAPACITORS ARE IN MFDT UNLESS OTHERWISE NOTED.

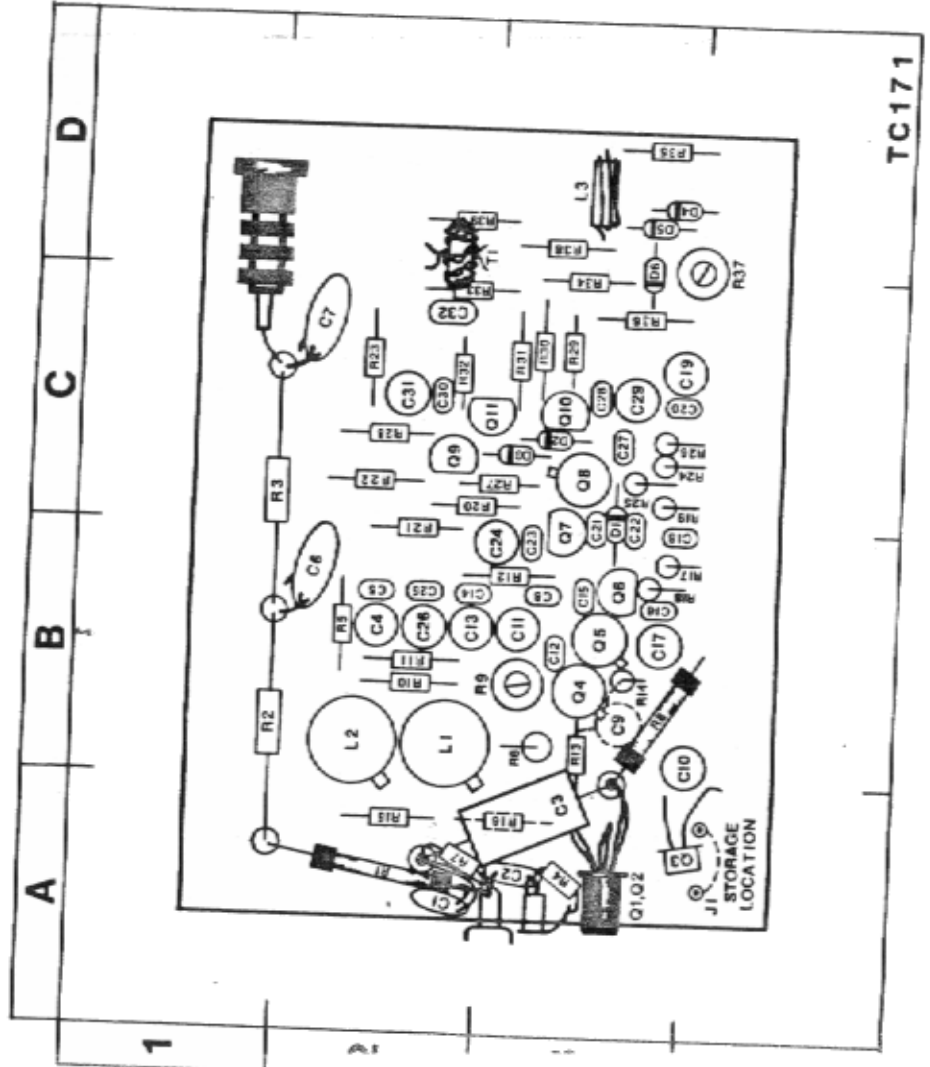

TC171