

**Università degli Studi di Firenze**  
sede di Empoli

**Corso di laurea in pianificazione della città del territorio e del paesaggio**

***LABORATORIO DI PIANIFICAZIONE TERRITORIALE E  
AMBIENTALE***  
**A.A. 2019-2020**

**Ecologia dell'insediamento umano**

**Docenti:**

Claudio Saragosa - **Pianificazione territoriale e ambientale**  
Iacopo Bernetti - **Pianificazione del territorio rurale**

**Tutor:**

Giacomo Rossi

**Gruppo di lavoro:**

Lorenzo Bambi - Tommaso Borghini – Sandro Sacchelli.

- **Basi concettuali per un' analisi ecologica dell' insediamento umano**
  - **L' Ecosistema Territoriale:  
le relazioni fra base ambientale e sistema insediativo**

- *Processi inter e transdisciplinari del pensiero scientifico moderno.*
- *Il pensiero sistemico nell' analisi territoriale.*
- *L' Ecosistema Territoriale*



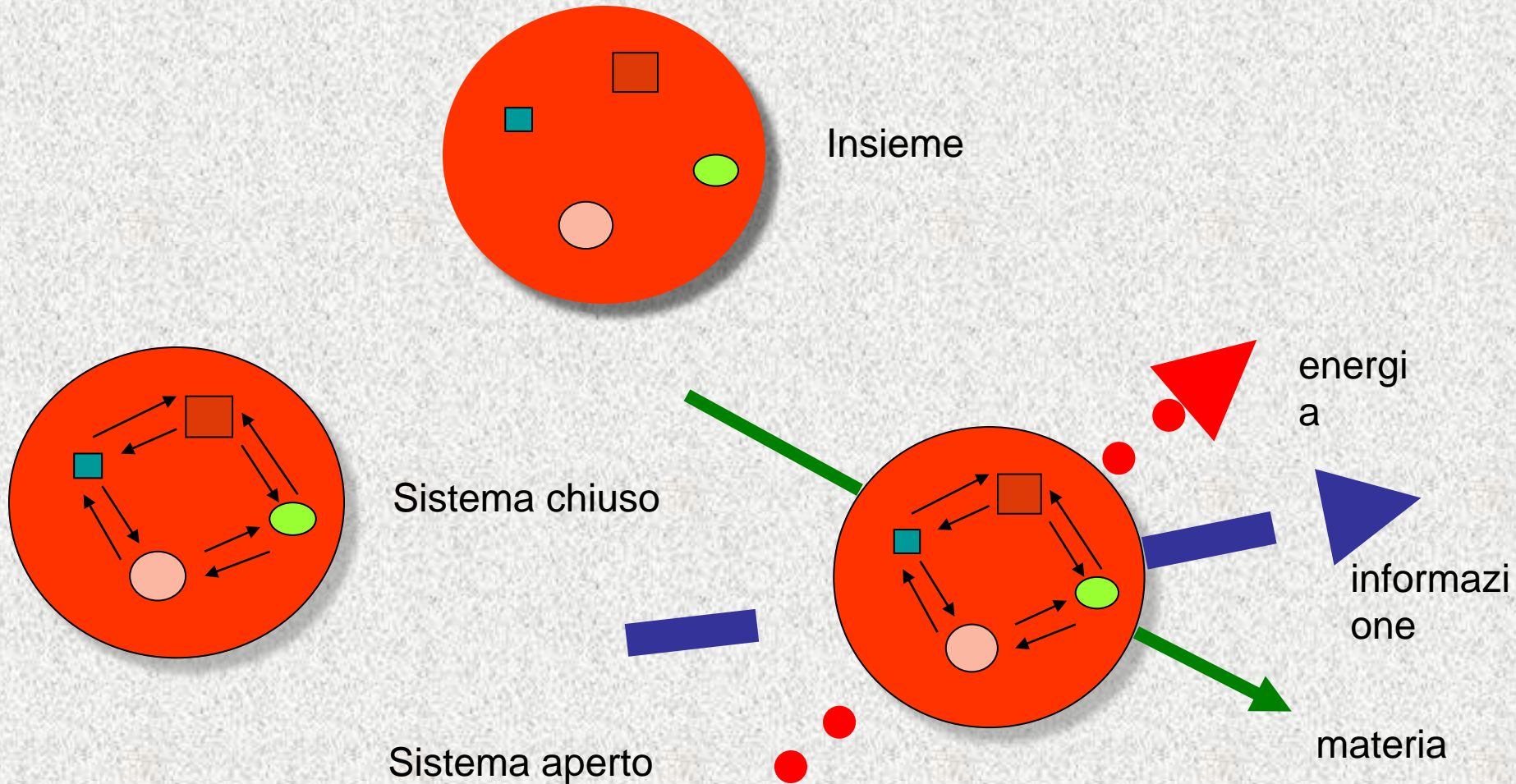
# 1. Processi inter e transdisciplinari del pensiero scientifico moderno.

(da Scandurra E., *L'ambiente dell'uomo. Verso il progetto della città sostenibile*, Etas Libri, Milano, 1995, pag. 11).



Figura 1.1 - Processi inter e transdisciplinari del pensiero scientifico moderno

## 2. Il pensiero sistemico nell'analisi territoriale.



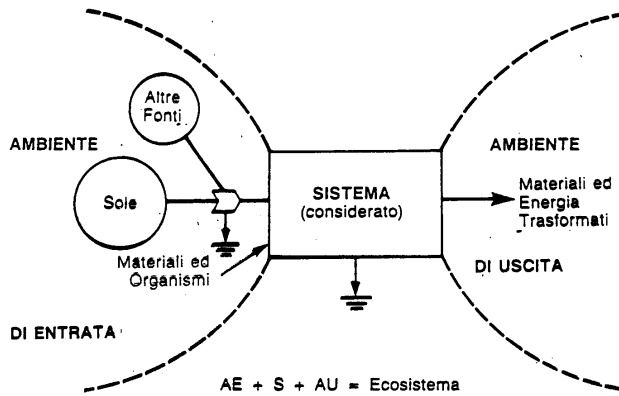


Fig. 1. Rapporto tra ecosistema ed ambiente esterno [Odum E.P., 1983].

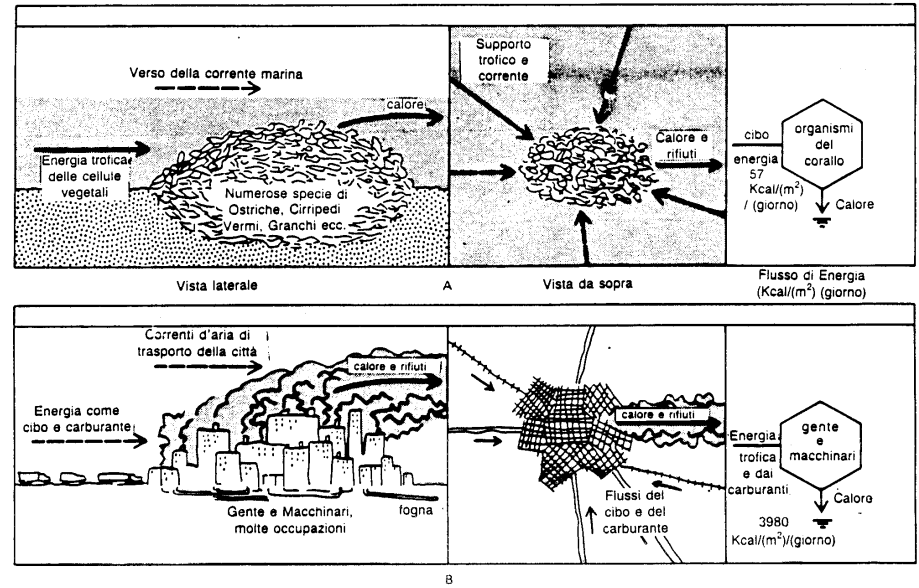


Fig. 3. Ecosistemi eterotrofi. A. Una delle "città" della natura - una colonia di ostriche che è dipendente dal flusso di cibo proveniente da un'ampia area circostante. B. Città industrializzata mantenuta da un enorme flusso di rifiuti e calore [Odum E.P., 1983].

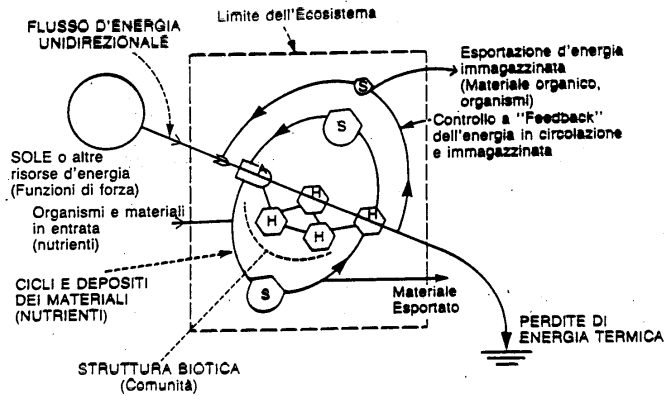


Fig. 2. Rappresentazione funzionale di un ecosistema. I quattro maggiori componenti sono rappresentati da: flusso di energia, cicli dei materiali, comunità, ed anello di retrocontrollo. La comunità è rappresentata da una rete alimentare costituita da autotrofi (A) ed eterotrofi (H), S indica l'energia immagazzinata [Scandurra E. 1995; Odum E.P., 1983].

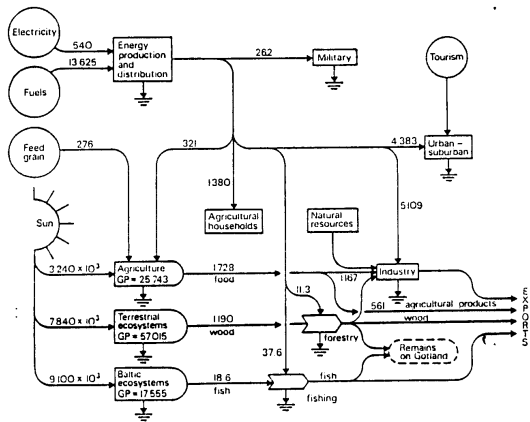


Fig. 5. Flussi energetici nell'ecosistema urbano della città di Gotland (in Douglas I. (1983), The Urban environment, Edward Arnold, London) [Verneti G., 1990].

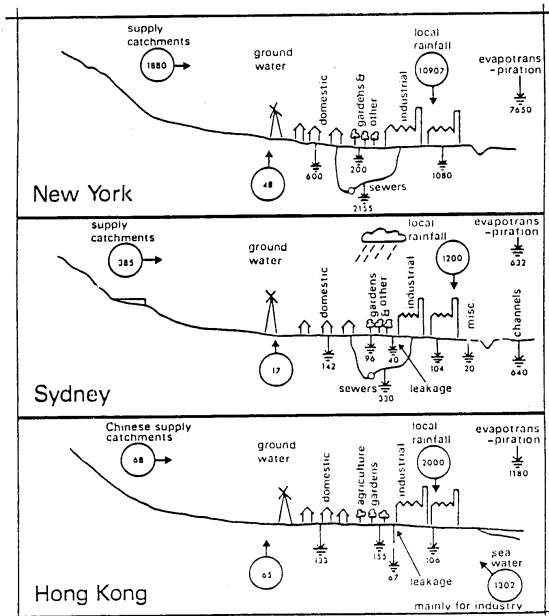


Fig. 6. Rappresentazione schematica del bilancio idrico urbano della città di New York, Sidney e Hong Kong (in Douglas I. (1983), The Urban environment, Edward Arnold, London) [Verneti G., 1990].

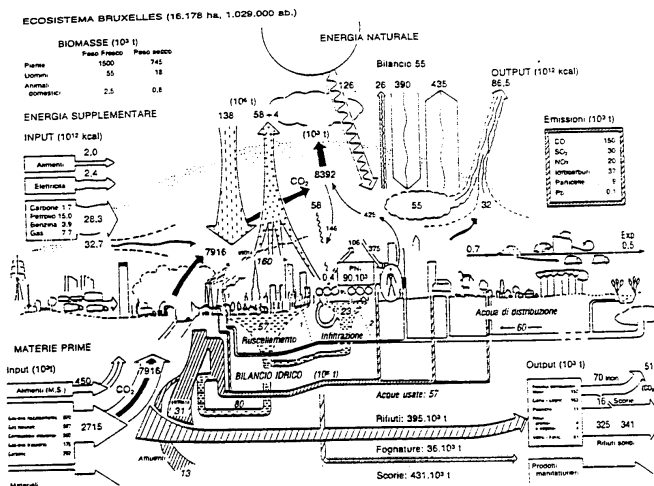


Fig. 7. Struttura e metabolismo dell'ecosistema urbano di Bruxelles [Bettini V., 1990].

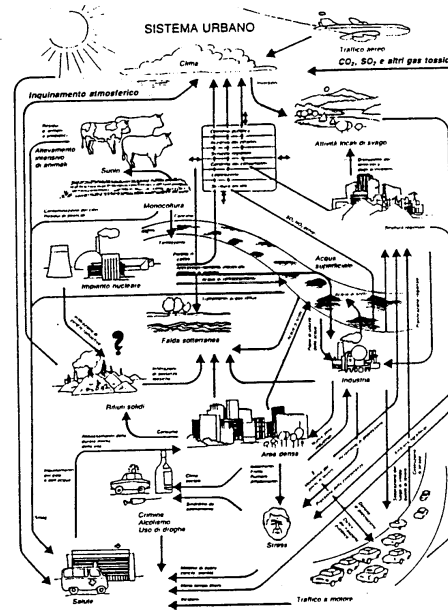
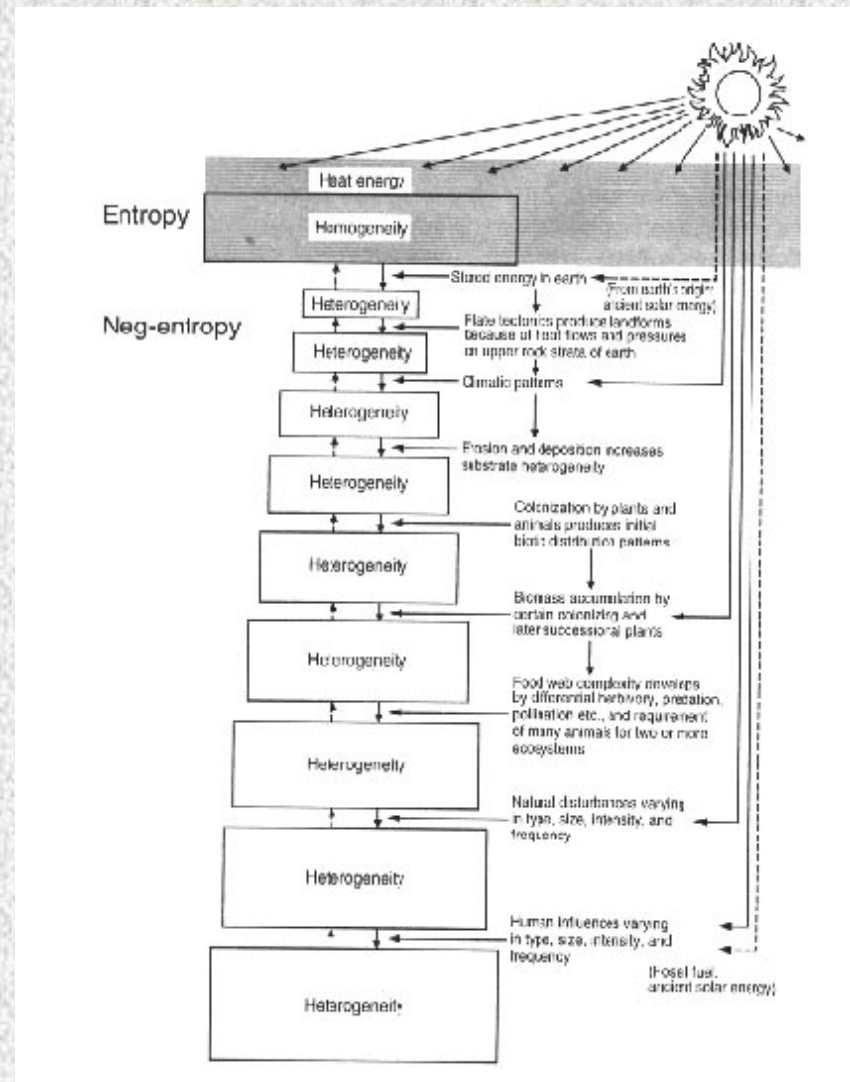
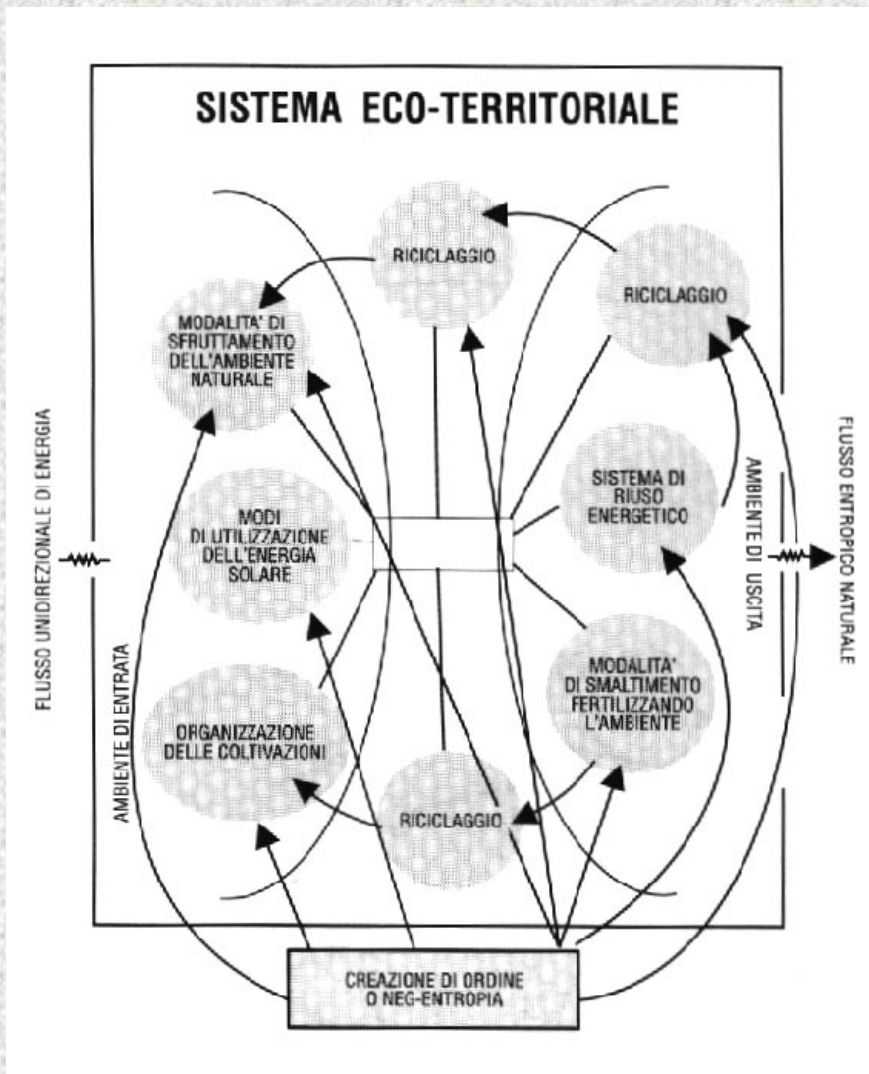
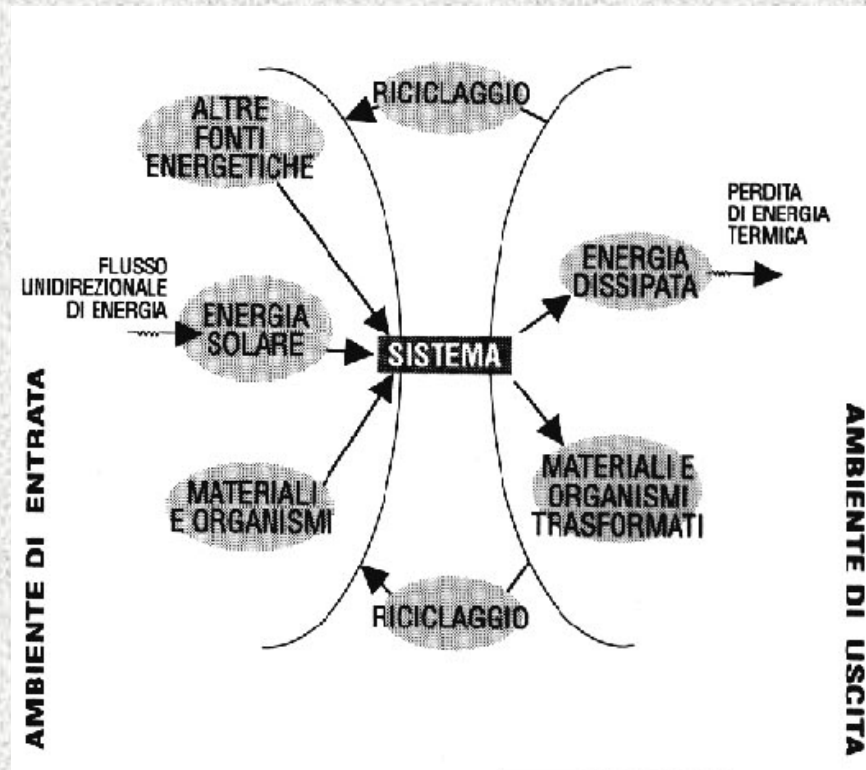


Fig. 8. In questo modello di sistema urbano [...] è illustrata la complessità delle interazioni che intercorrono tra le varie componenti di un sistema urbano, e tra un insediamento urbano e il suo hinterland [Bettini V., 1990].







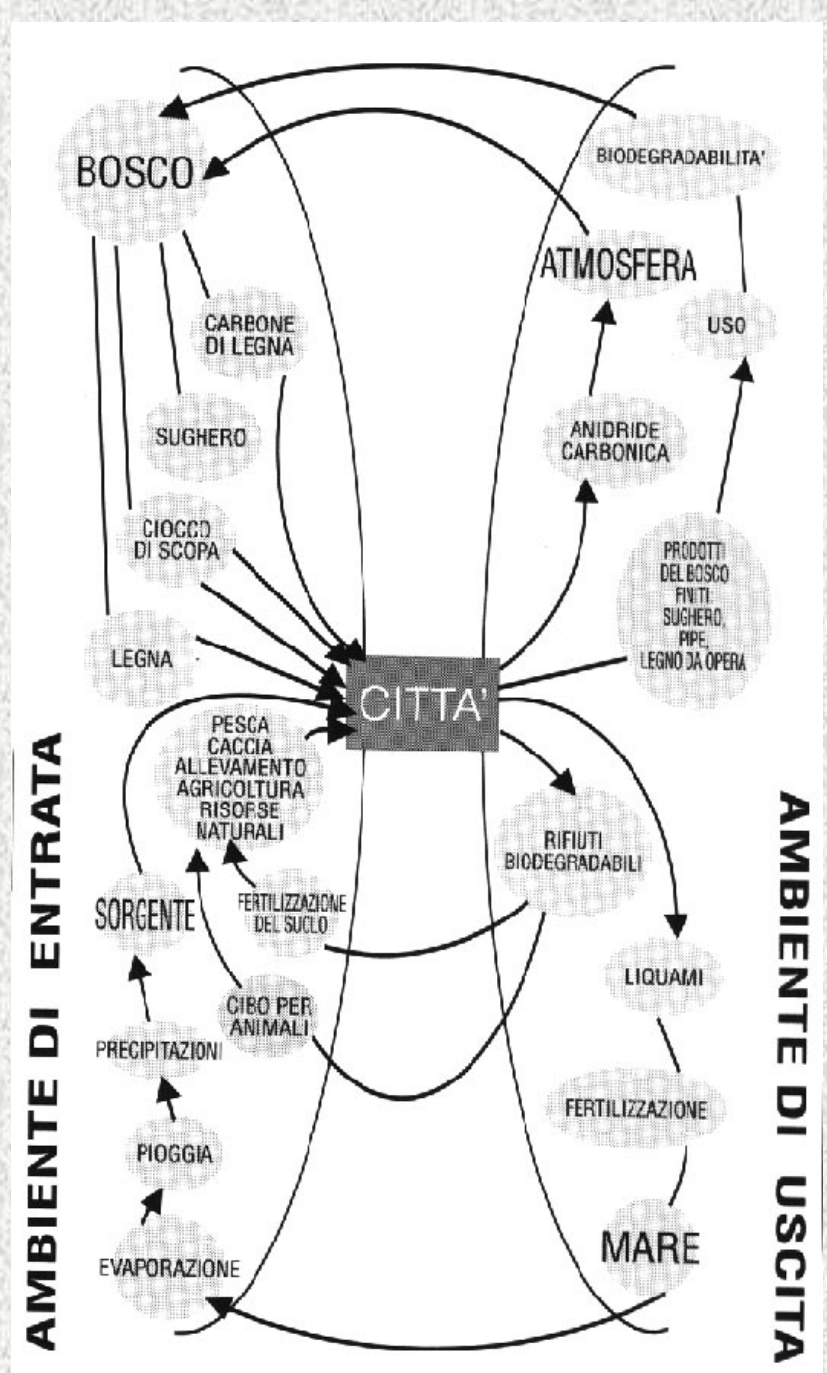
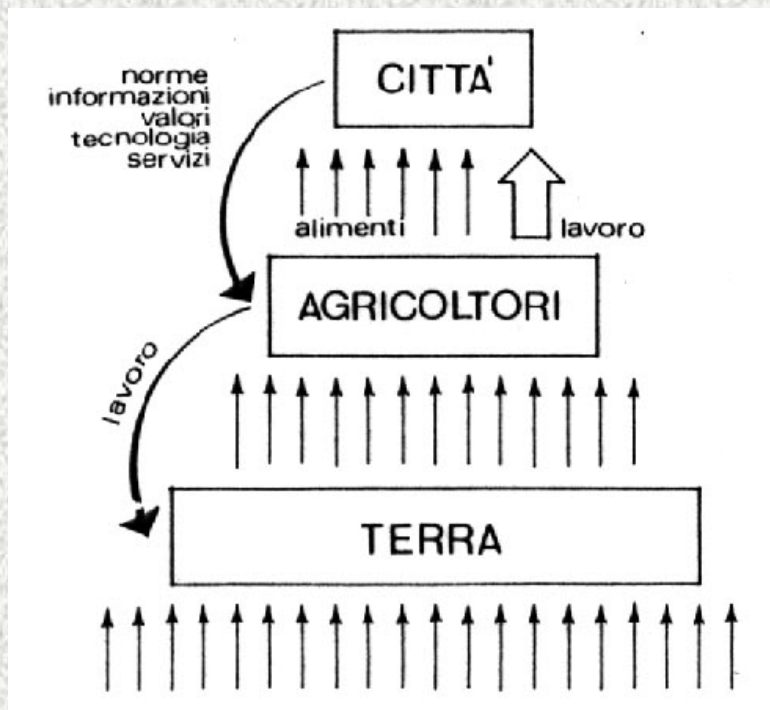
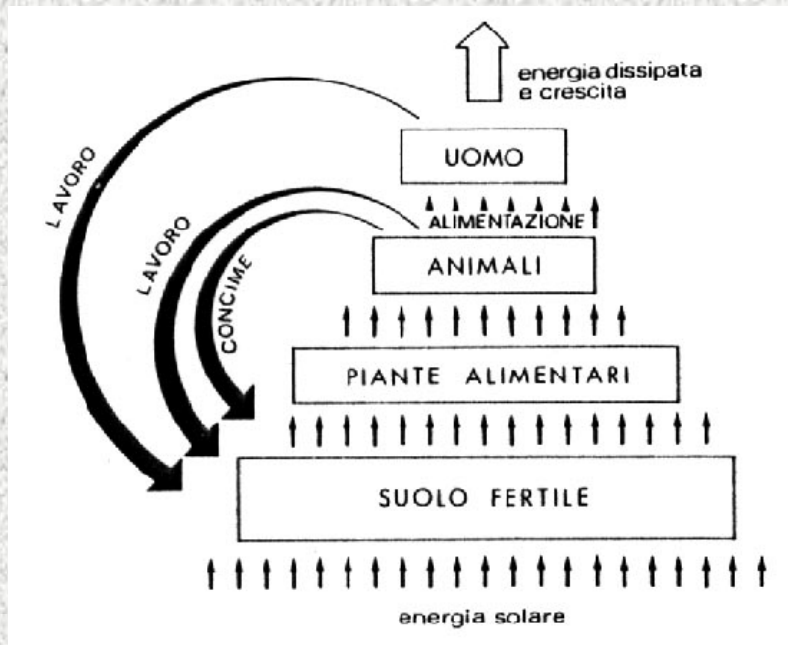


Schema

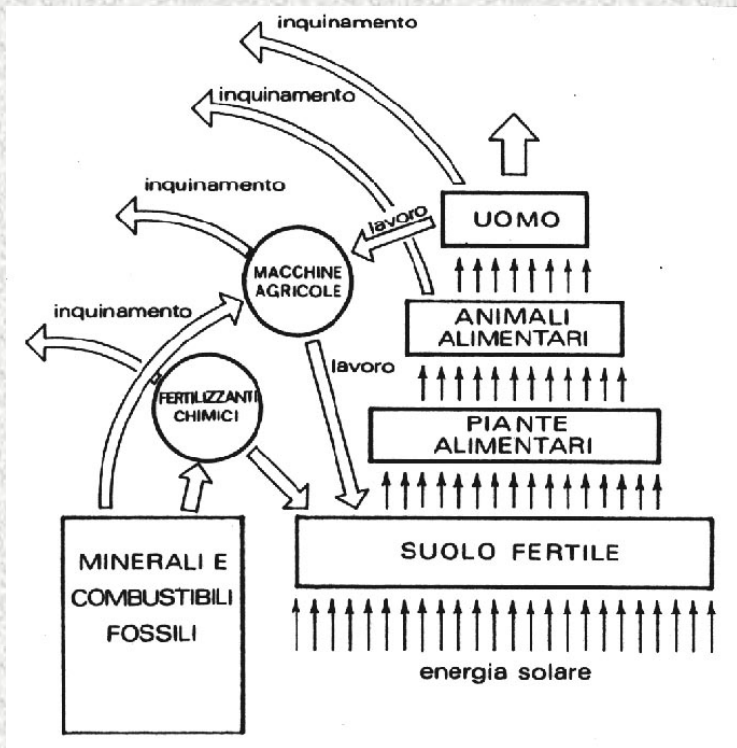
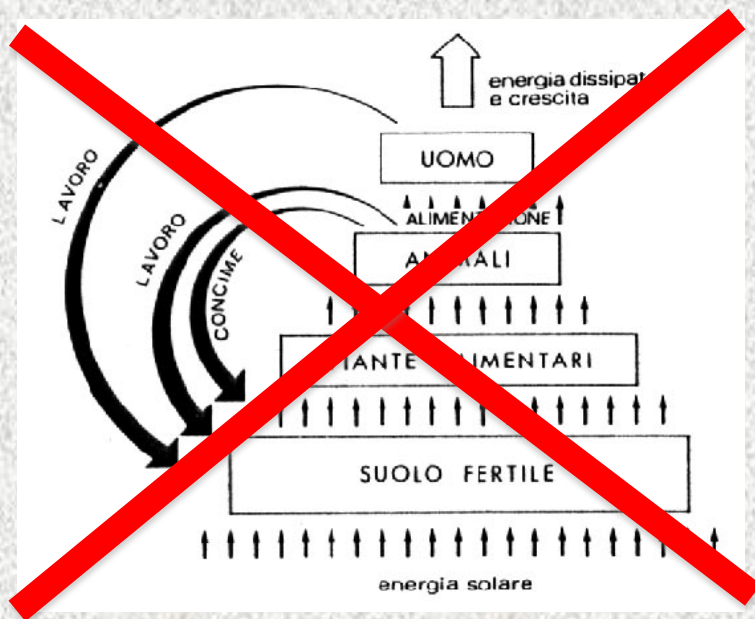
Struttura

Processo

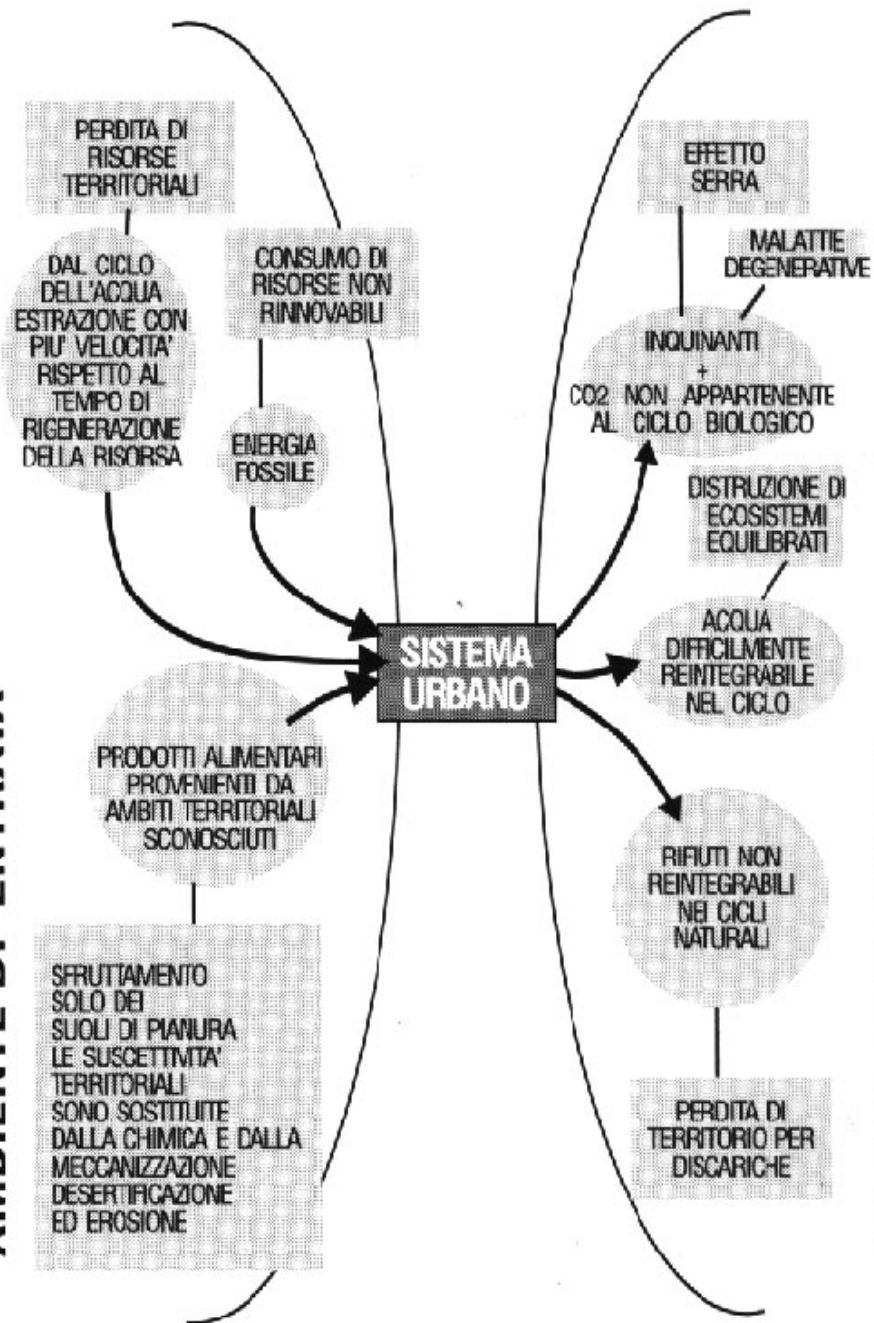
Capra propone di interpretare l'autopoiesi, definita da Maturana e Varela, come lo schema della vita (cioè come lo schema di organizzazione dei sistemi viventi); la struttura dissipativa, definita da Prigogine, come la struttura dei sistemi viventi; e la cognizione, definita inizialmente da Gregory Bateson e in modo più completo da Maturana e Varela, come il processo della vita



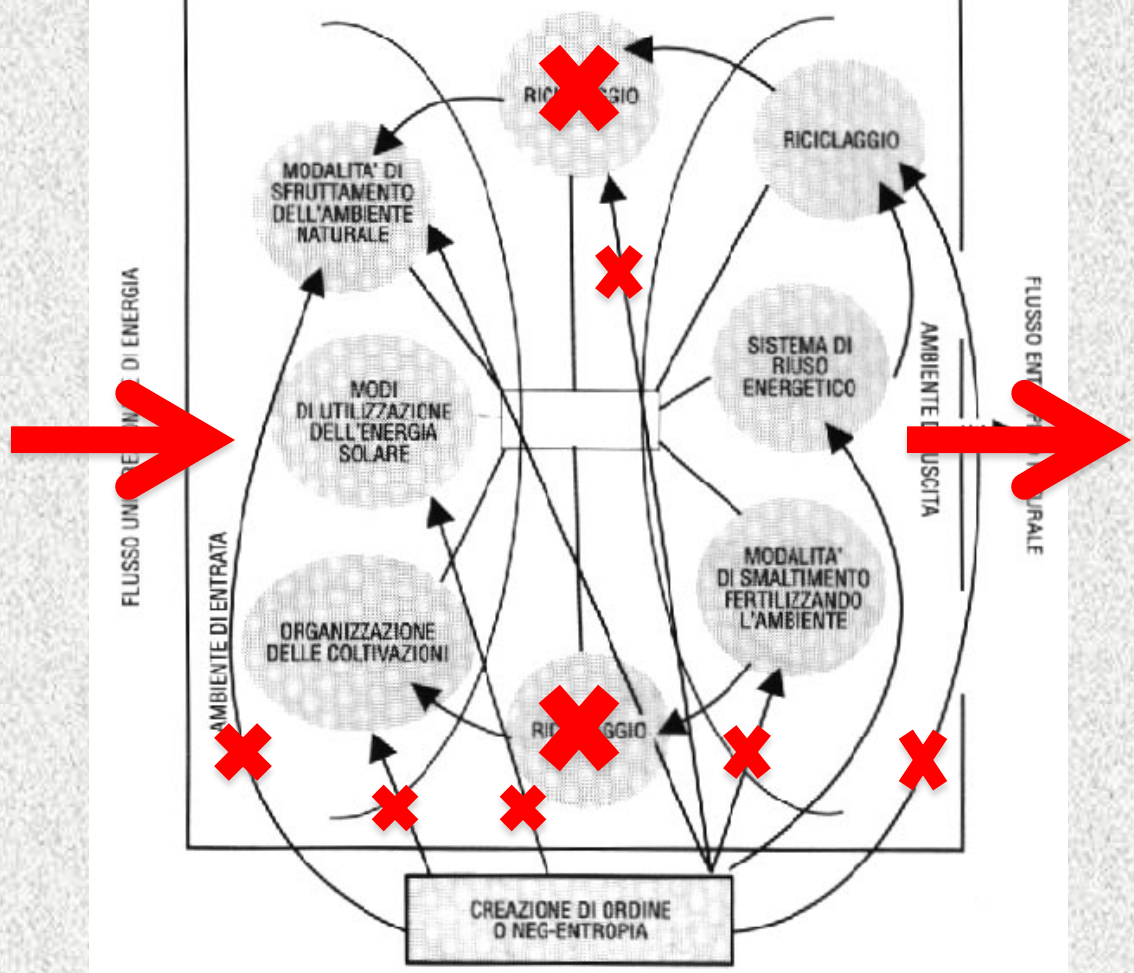




**AMBIENTE DI ENTRATA**

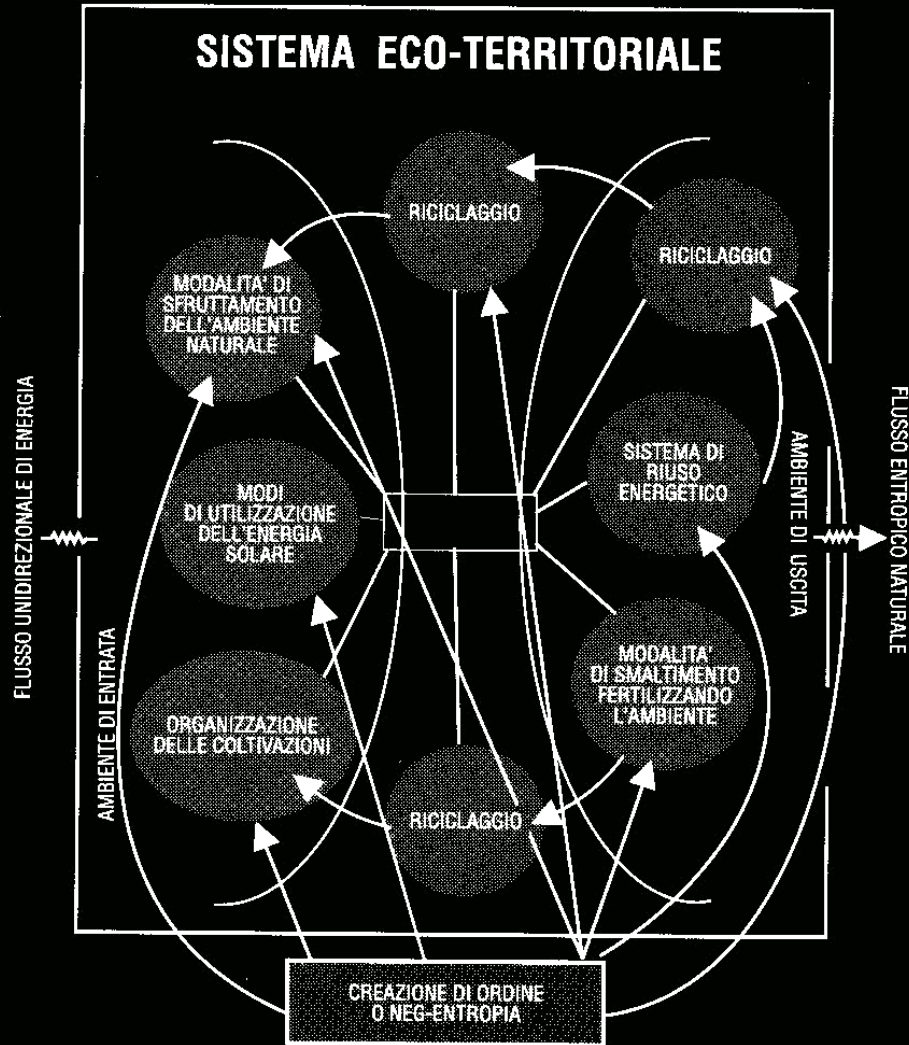


# SISTEMA ECO-TERRITORIALE





# L' Ecosistema Territoriale





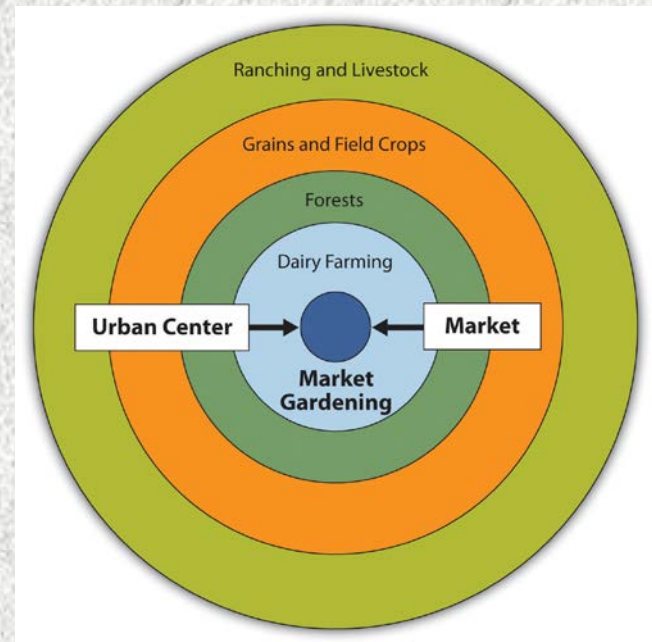
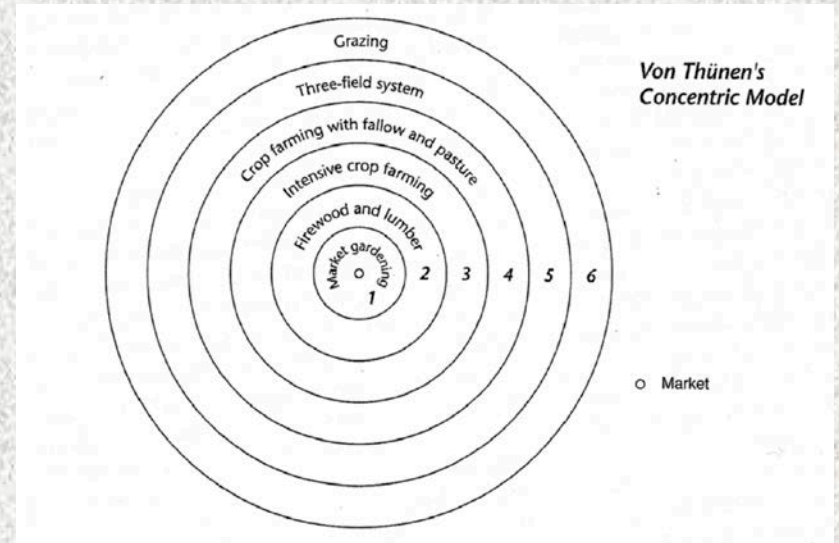
# Una metafora: la città albero

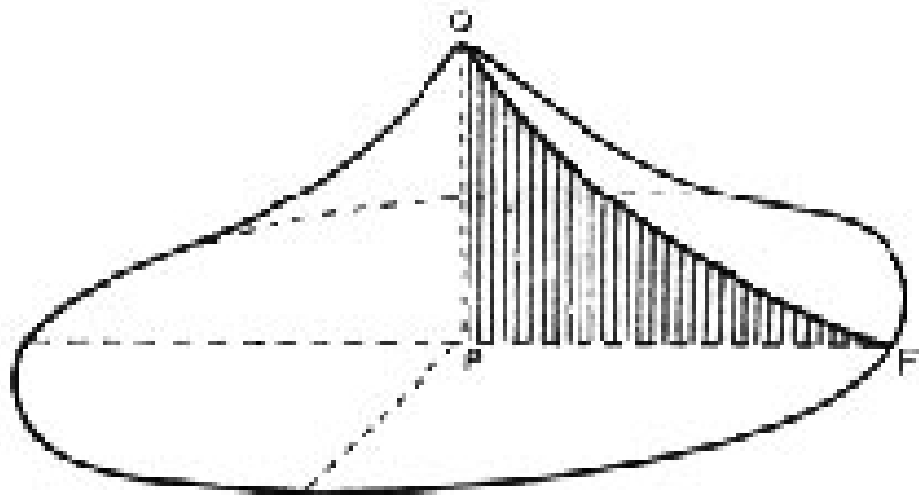
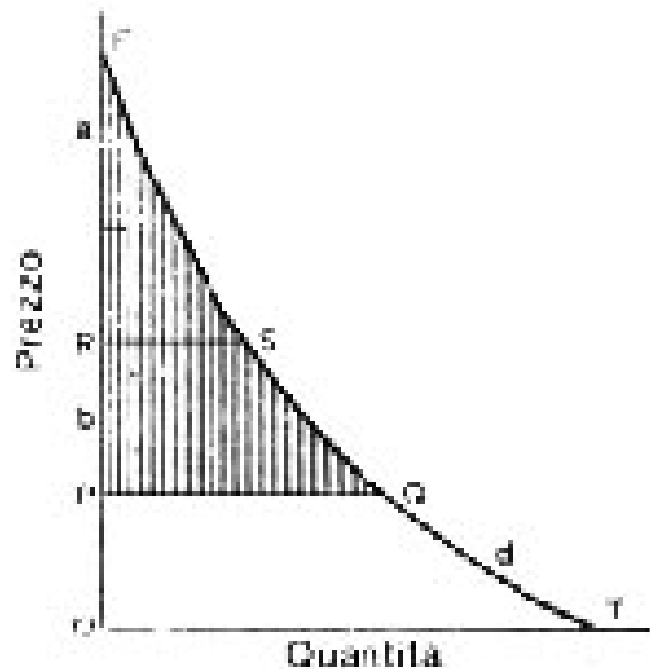




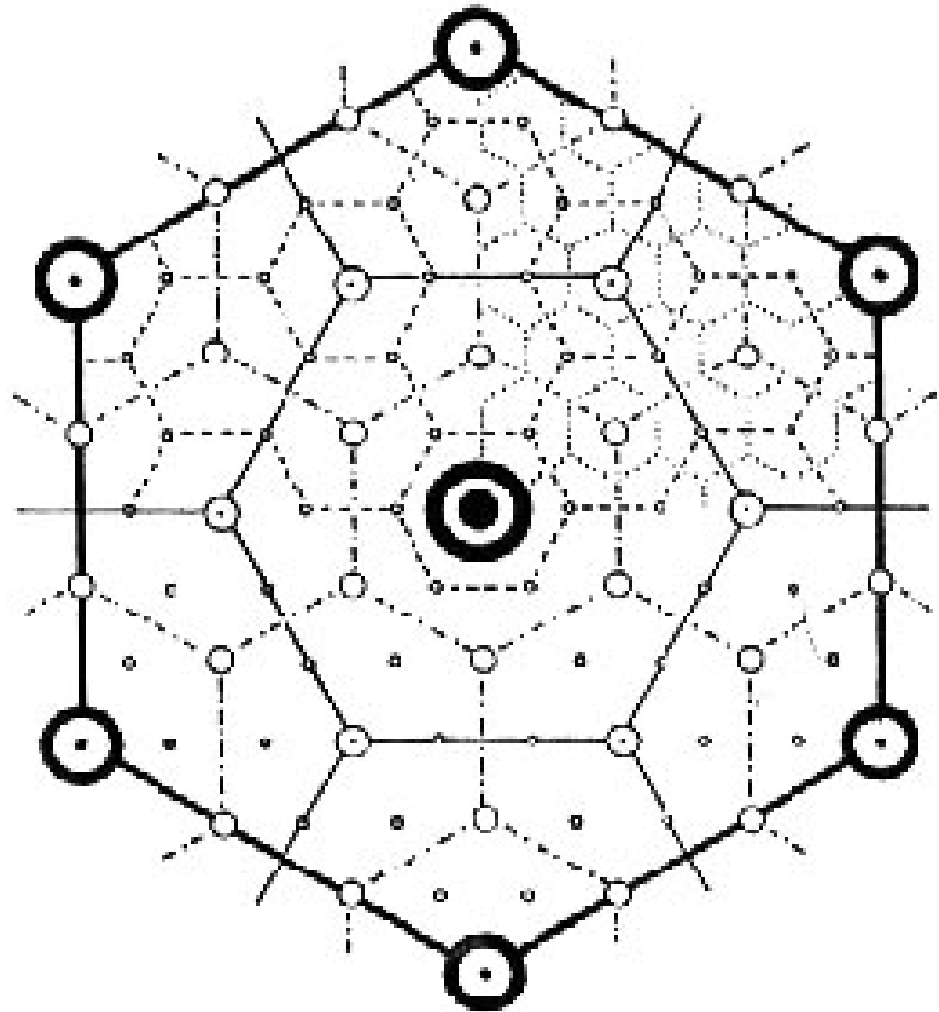
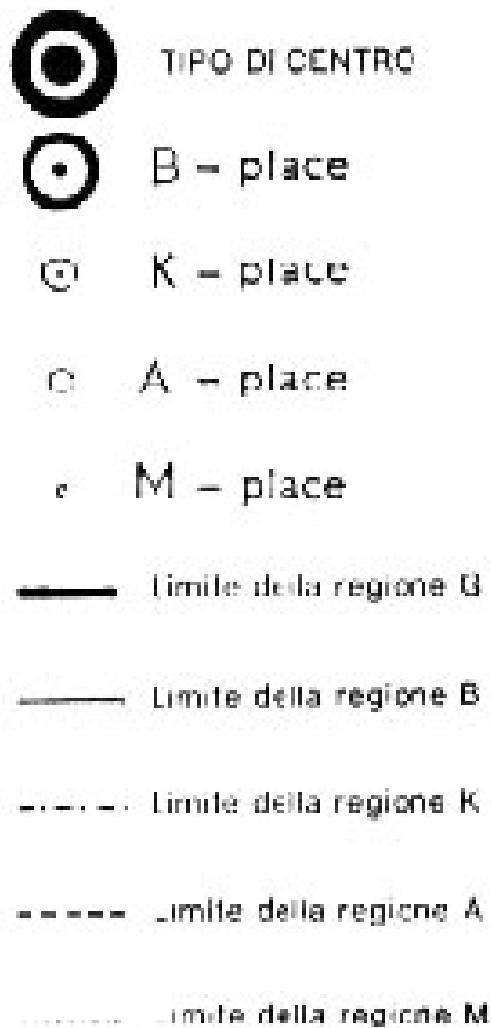


# Il modello a cerchi concentrici di Johannes von Thunen





Il procedimento di Lösch per ricavare l'area di mercato e il cono della domanda dalla curva di domanda di un prodotto in funzione della distanza (tratta da Carter H. (1980), *La geografia urbana. Teoria e metodi*, Zanichelli, Bologna).



Il sistema dei luoghi centrali secondo Christaller (tratta da Carter H. (1980), *La geografia urbana. Teoria e metodi*, Zanichelli, Bologna).



Zentrenhierarchie

-  L
-  P
-  G
-  B
-  K
-  A
-  M

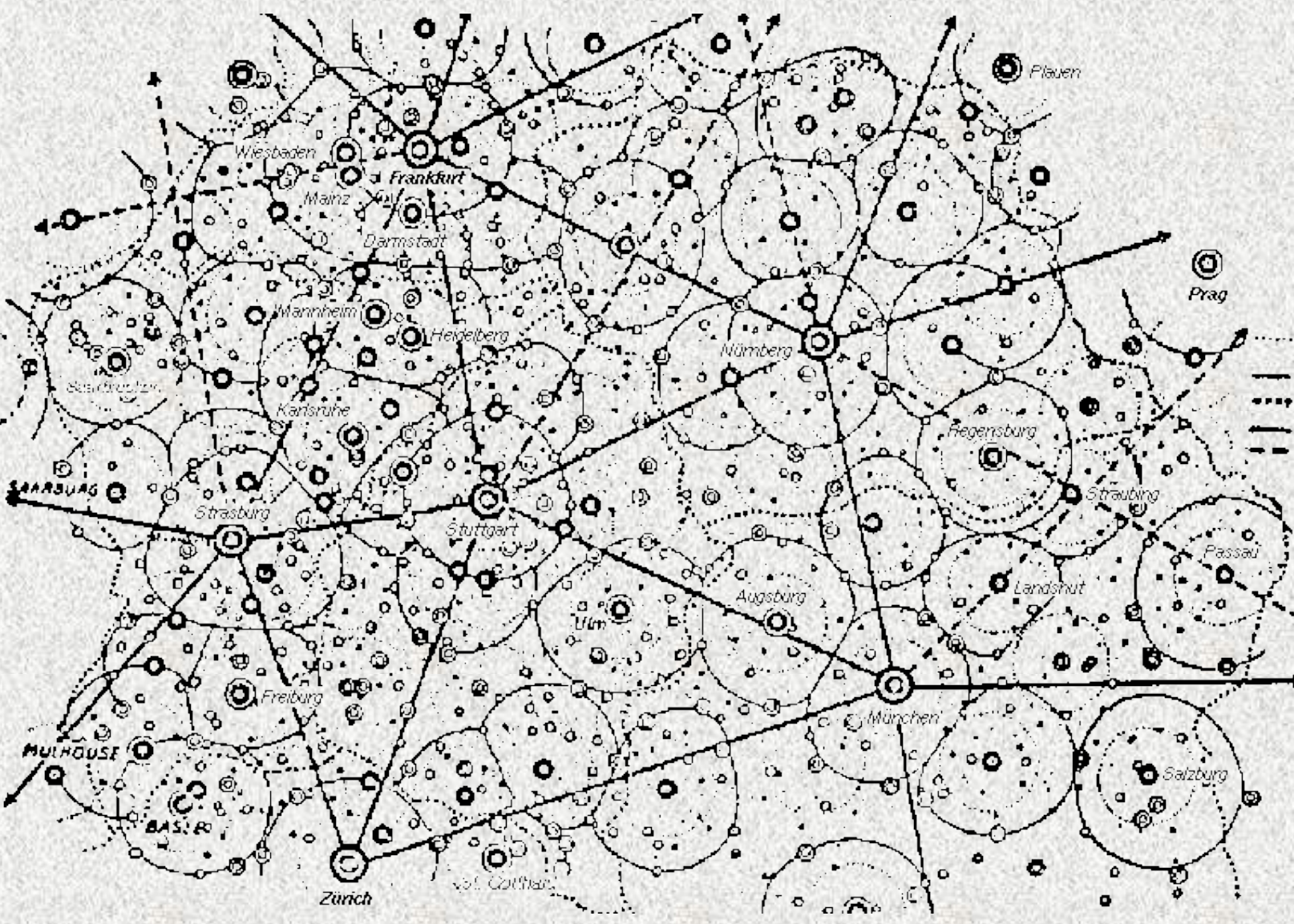
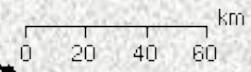
..... K: 21-km-Ring

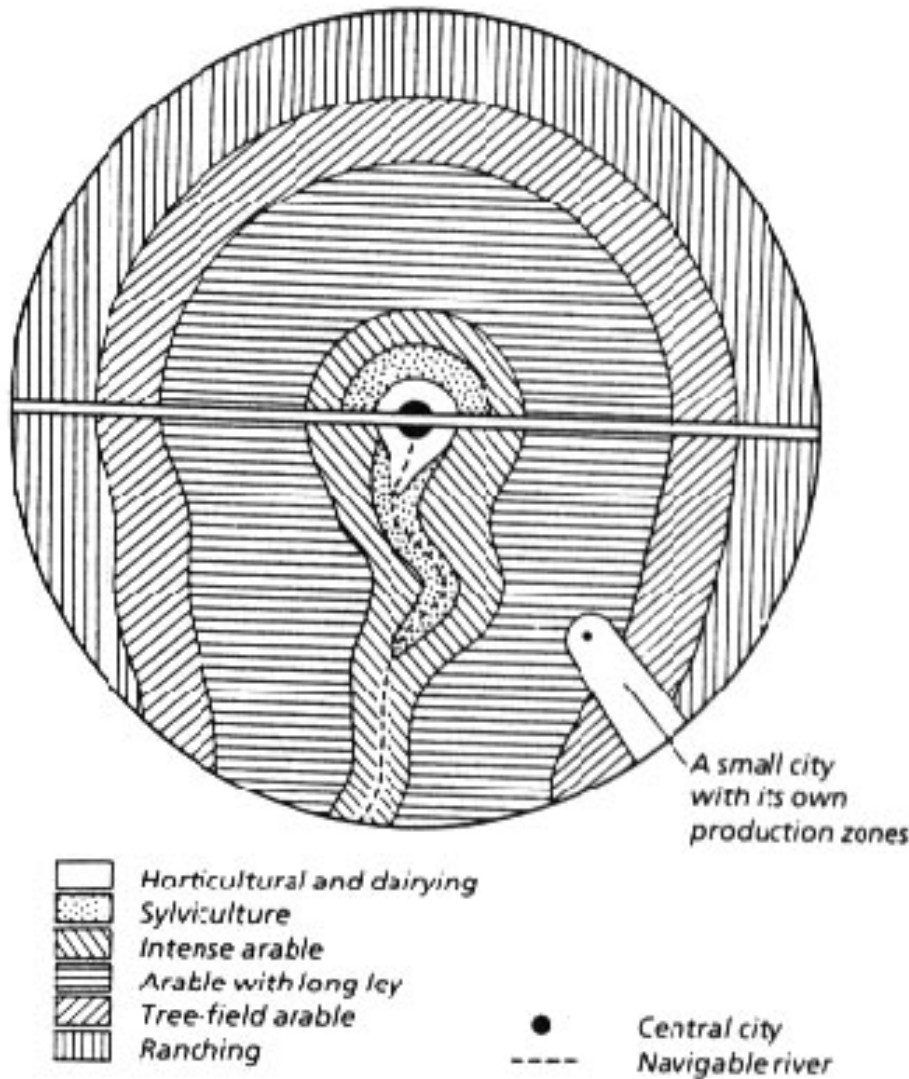
—— B-Ring

..... L-Systeme

—— Primär- Verbindung zw.

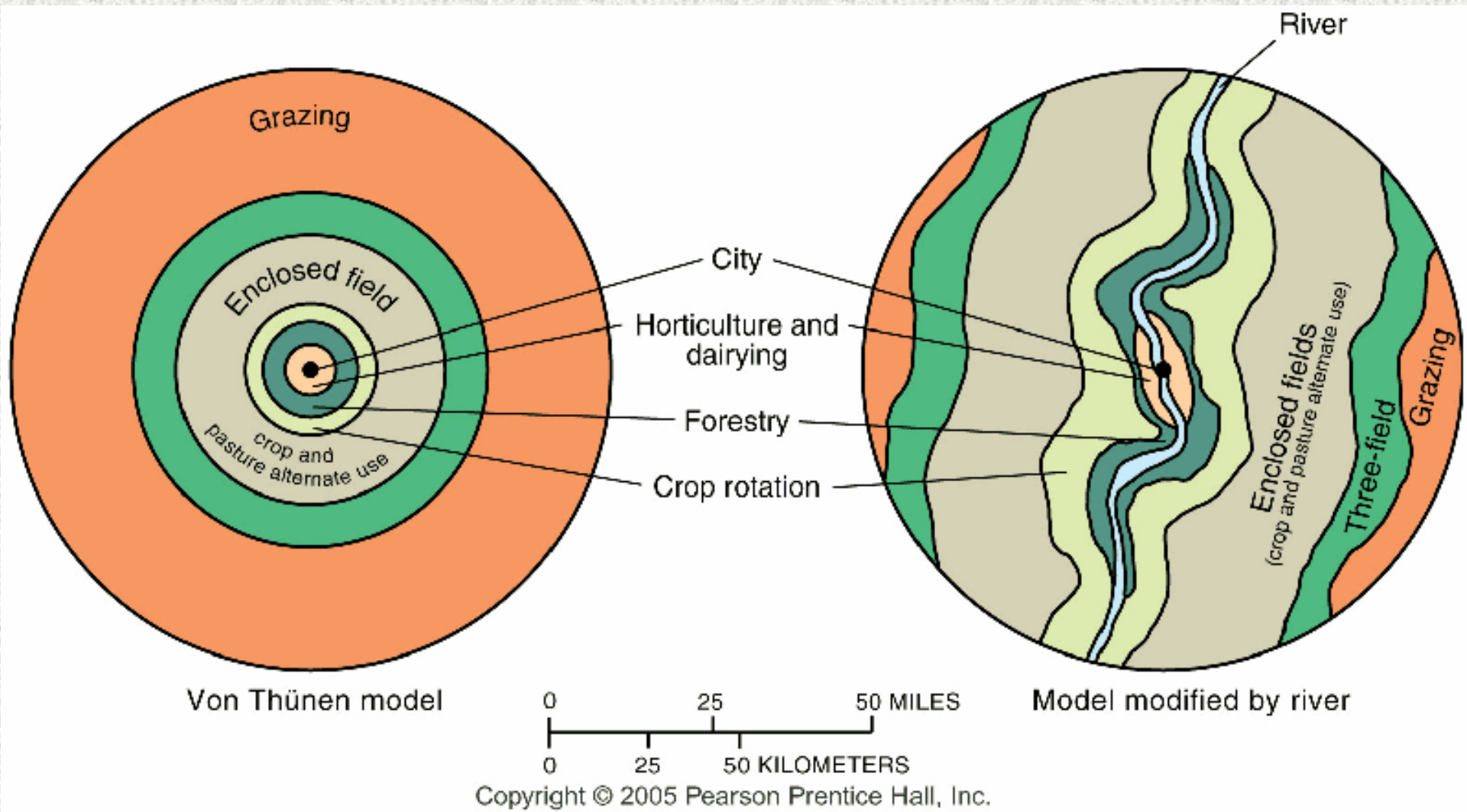
..... Sekundär- L-Zentren

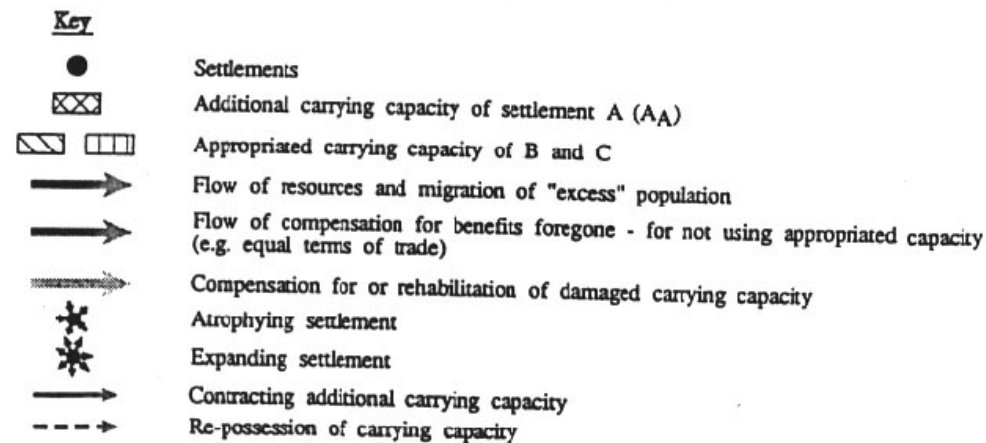
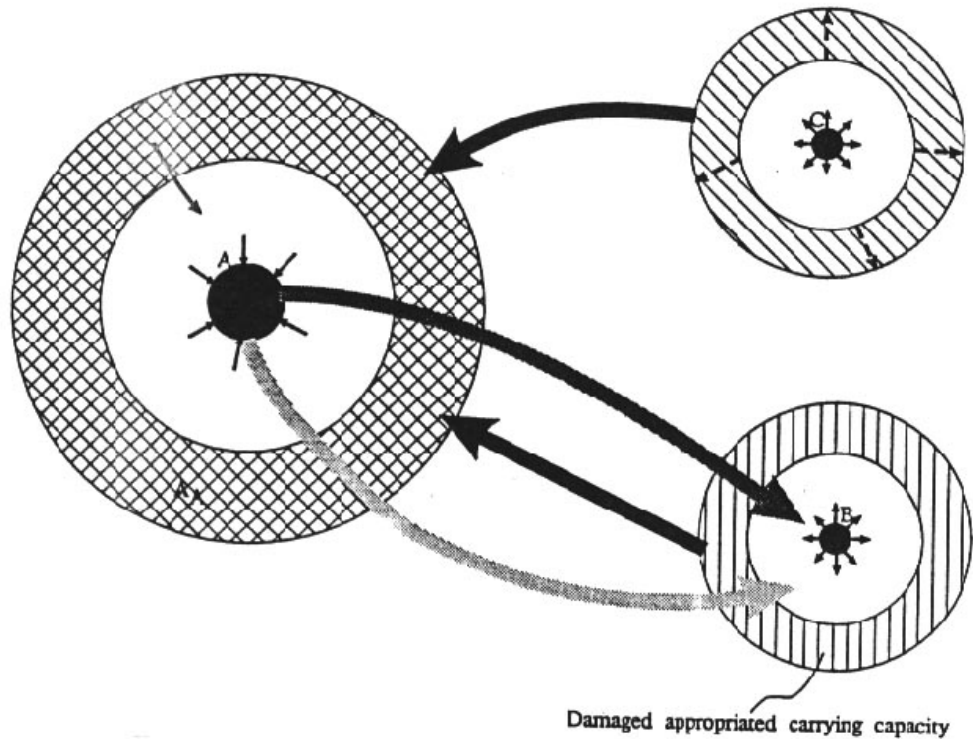




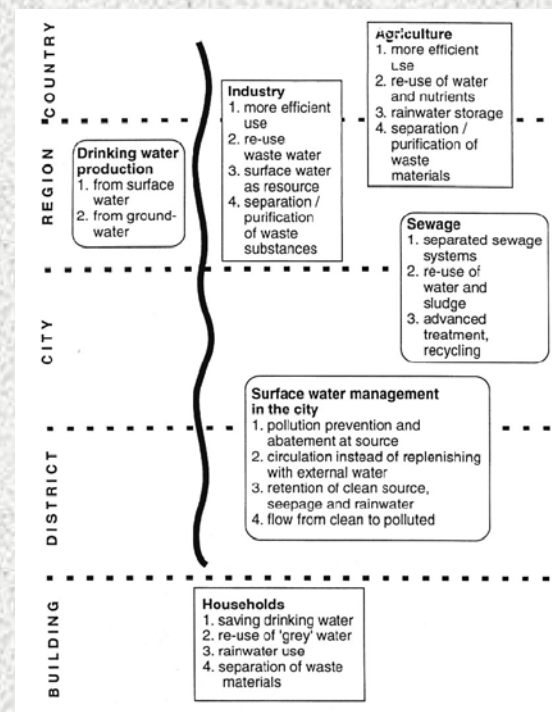
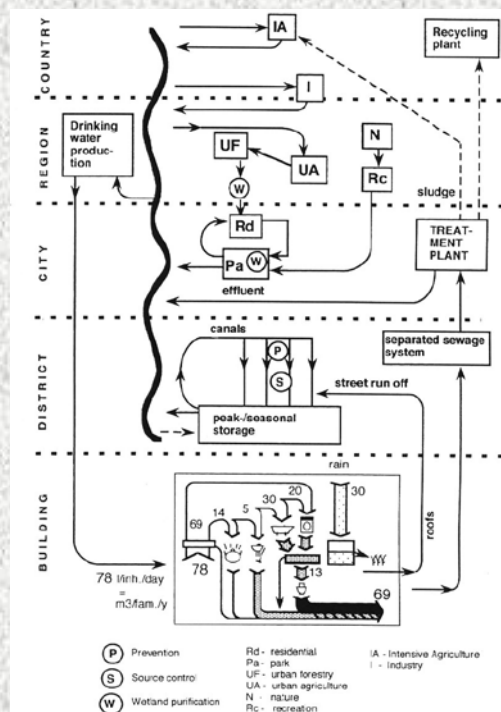
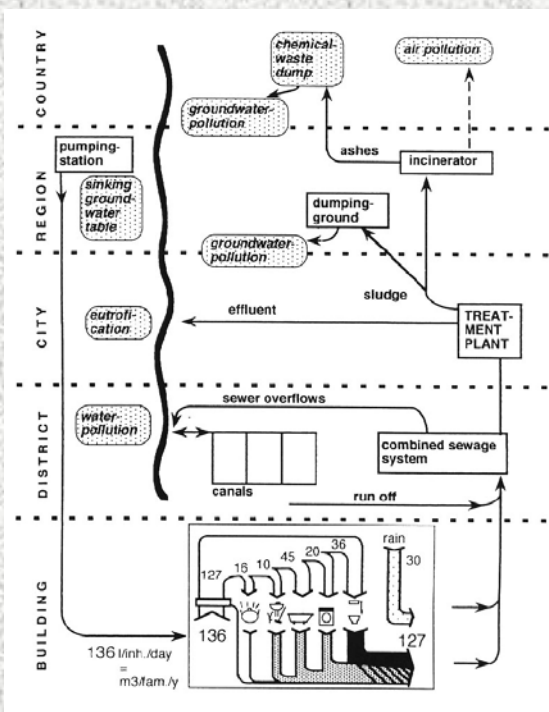
Progettare gli hinterlands delle città. In questo schema viene identificato l'ambiente di riferimento di un piccolo insediamento umano. Secondo l'autore le città hanno bisogno di assicurare la continuità degli ecosistemi locali preesistenti: luoghi di grande diversità naturale come montagne boscate, colline, prati, insenature e laghi. La salute e l'integrità di questi ecosistemi infatti assicura la continuità della vita locale, con inclusione della popolazione umana. Lo schema è tratto da quello proposto agli inizi del XIX secolo da Von Thünen. Vicino all'insediamento si trova un anello di orti. All'esterno del quale si hanno dei frutteti e dei pascoli che producono frutta e pollame. Al di fuori troviamo le foreste per il legname da ardere e da costruzione, mentre più lontano troviamo i campi per coltivare grano e verdure. (tratta da Girardet H. (1992), *The Gaia Atlas of Cities. New directions for sustainable urban living*, Gaia Books Ltd., London).





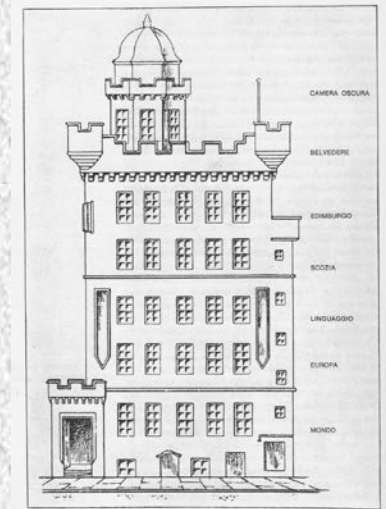
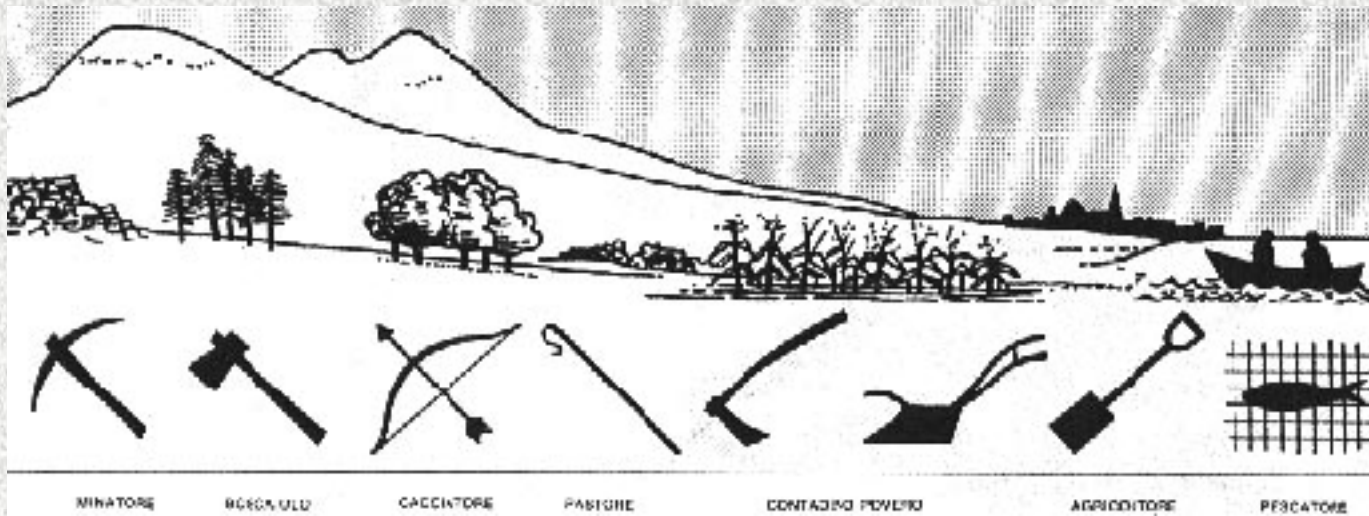


Modello concettuale di un sistema mondo di insediamenti sostenibili. Con questo schema si vuole sostanziare l'idea che per raggiungere la sostenibilità, le città debbono ripensare al proprio sistema di entrata delle risorse e di uscita dei rifiuti. Solo in un organizzazione territoriale di tal genere è possibile raggiungere la sostenibilità locale e la sostenibilità globale. Ciò, ovviamente, non implica l'autarchia territoriale, al contrario, in un sistema di centri in equilibrio con il proprio ambiente, si possono instaurare una serie complessa di scambi di materia-energia-informazione (tratta da Stren R., White R., Whitney J. (1992), *Sustainable Cities. Urbanization and the Environment in International Perspective*, Wetsview Press, Boulder-San Francisco-Oxford).

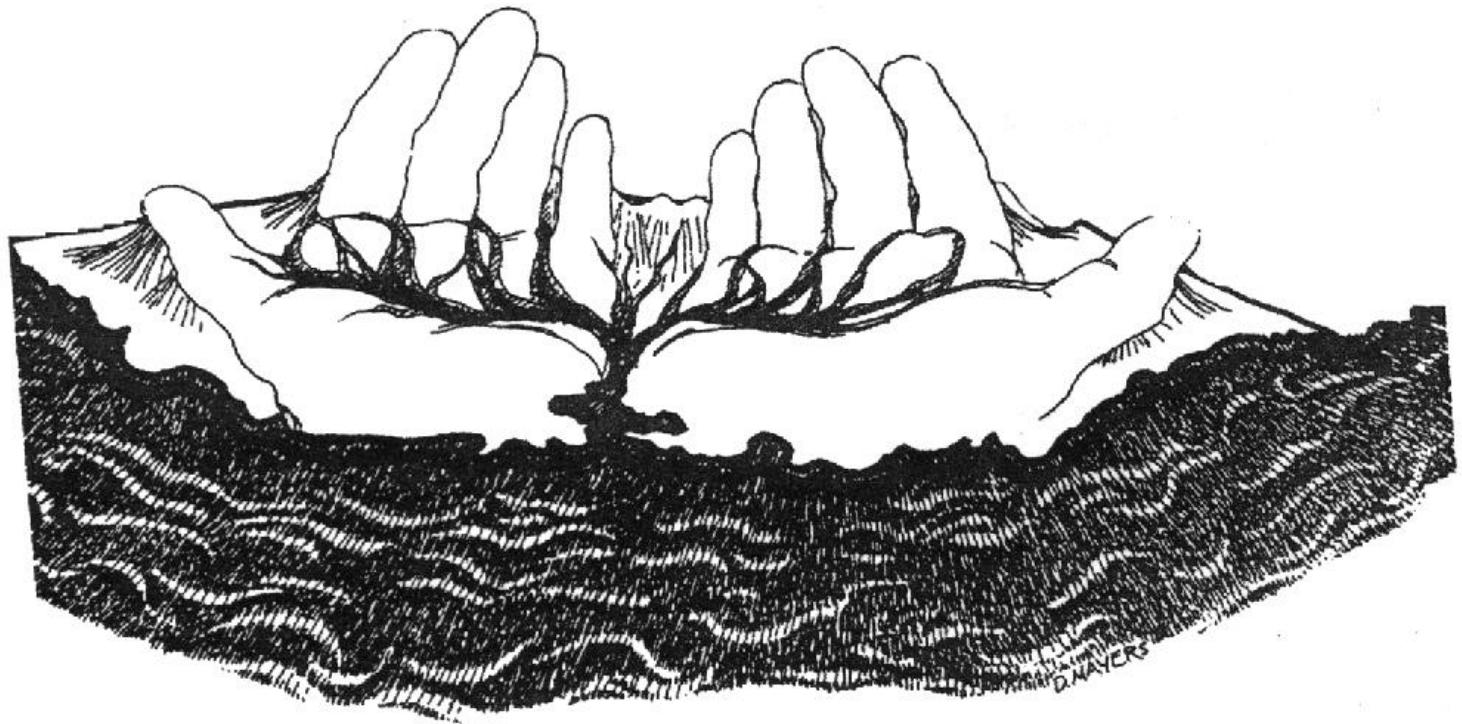


Come reimpostare un ciclo dell'acqua di un insediamento umano, in un'esperienza olandese. L'analisi svolta, parte dalla individuazione delle problematiche ambientali esistenti (Fig. A.); si individua una strategia generale di interventi (Fig. B.); si definisce un modello guida per il lungo periodo al fine di riequilibrare il sistema insediativo rispetto al sistema ambientale (Fig. C.). E' interessante vedere come si studi le modalità di riequilibrio dell'insediamento partendo dall'edificio per giungere al livello regionale e nazionale. Molta attenzione è spesa per richiudere localmente il sistema dei flussi di materia-energia. Lo stesso tipo di approccio è stato sviluppato per i rifiuti ed i trasporti (tratta da Tjallingii S.P. (1995), *Ecopolis. Strategies for Ecologically Sound Urban Development*, Backhuys Publishers, Leiden).



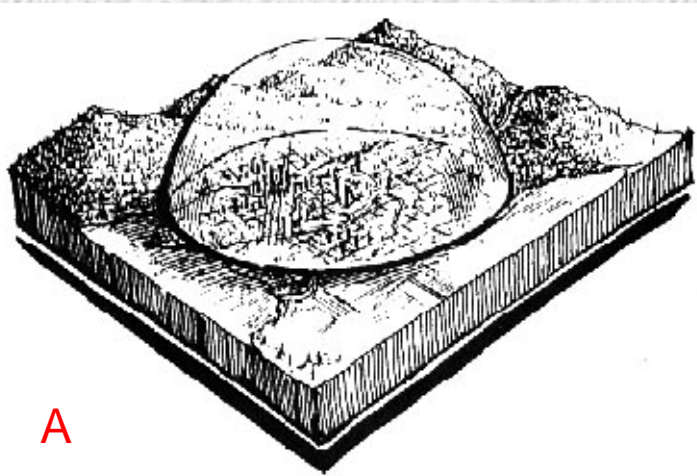


La sezione di valle e l' outlook tower di Patrick Geddes (tratta da Geddes P. (1970), *Città in evoluzione*, Il Saggiatore, Milano).

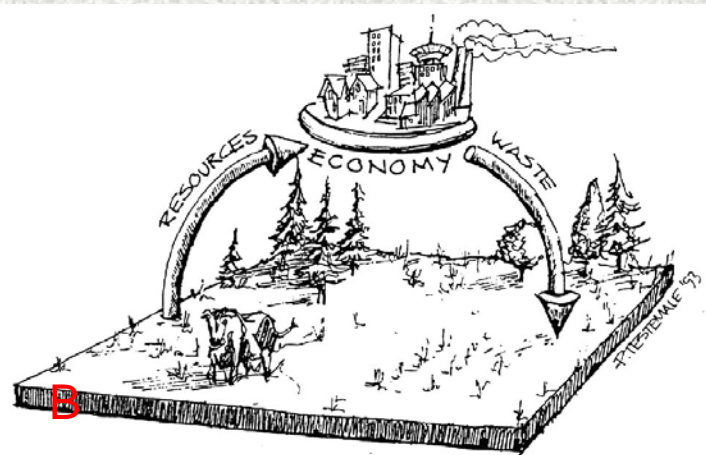


Una rappresentazione bioregionalista: la nazione Shasta (San Francisco).  
(tratta da: Rete Bioregionale Italiana (1997), *La terra racconta. Il Bioregionalismo e l'arte di disegnare le mappe locali*, Edizioni AAM TerraNuova, Borgo San Lorenzo (FI)).

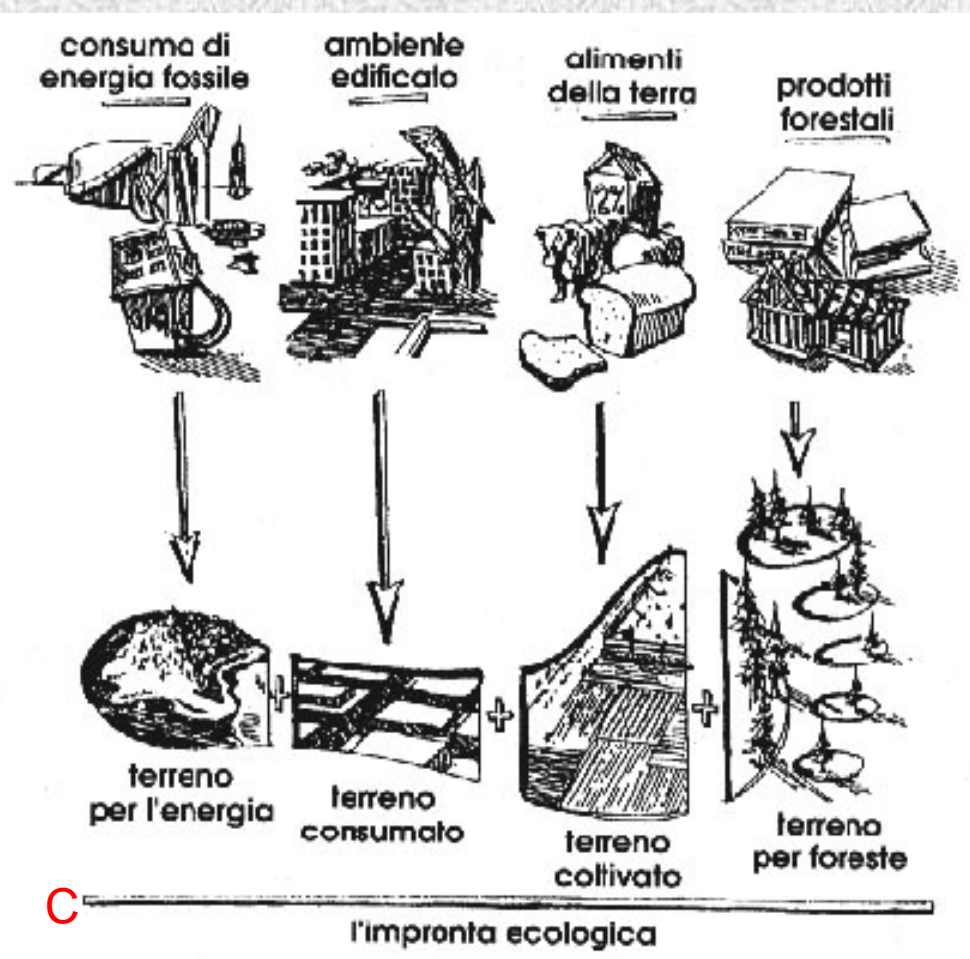




A



B



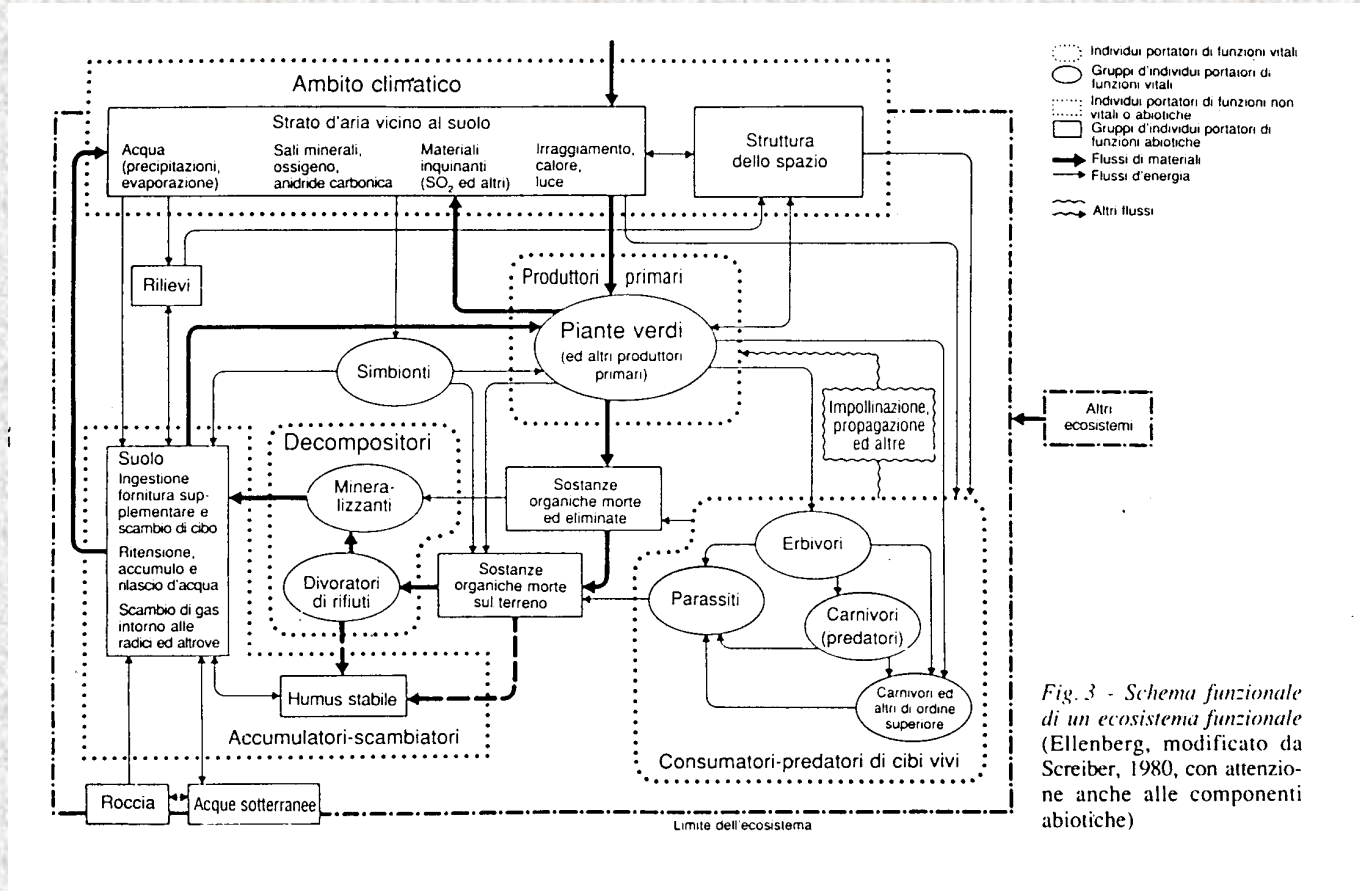
C

**A.** La cupola di vetro ideale che rappresenta il territorio perché una città possa sopravvivere basandosi solo sugli ecosistemi presenti nella cupola stessa (tratta da Wackernagel M., Rees W.E. (1996), *L'impronta ecologica. Come ridurre l'impatto dell'uomo sulla terra*, Edizioni Ambiente, Milano). **B.** Schema della terra richiesta per il metabolismo della città (tratta da Wackernagel M., Rees W.E. (1996), *L'impronta ecologica. Come ridurre l'impatto dell'uomo sulla terra*, Edizioni Ambiente, Milano). **C.** Esprimere i consumi in superficie di terra produttiva. La produzione e l'uso di ogni bene e servizio dipendono da vari tipi di produttività ecologica. Queste produttività ecologiche possono essere espresse in una equivalente superficie di terreno. Sommando il terreno richiesto per tutte le categorie significative di consumo e di rifiuti si ottiene come risultato l'Impronta Ecologica totale della popolazione di riferimento (tratta da Wackernagel M., Rees W.E. (1996), *L'impronta ecologica. Come ridurre l'impatto dell'uomo sulla terra*, Edizioni Ambiente, Milano).



# Le relazioni fra insediamento umano e sistema ambientale

## La base ambientale dell'ecosistema territoriale



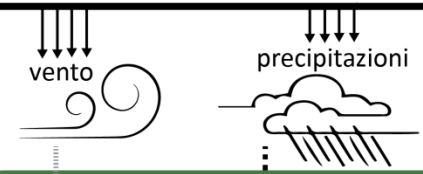
Schema funzionale di un ecosistema funzionale (tratta da Finke L. (1993), *Introduzione all'ecologia del paesaggio*, Angeli, Milano).

# FLUSSI DI ENERGIA NEGHENTROPICI

# FLUSSI ENTROPICI

perdita di energia termica

AMBIENTE DI ENTRATA



## ecosistema territoriale

### FLUSSI DI ENERGIA FOSSILE

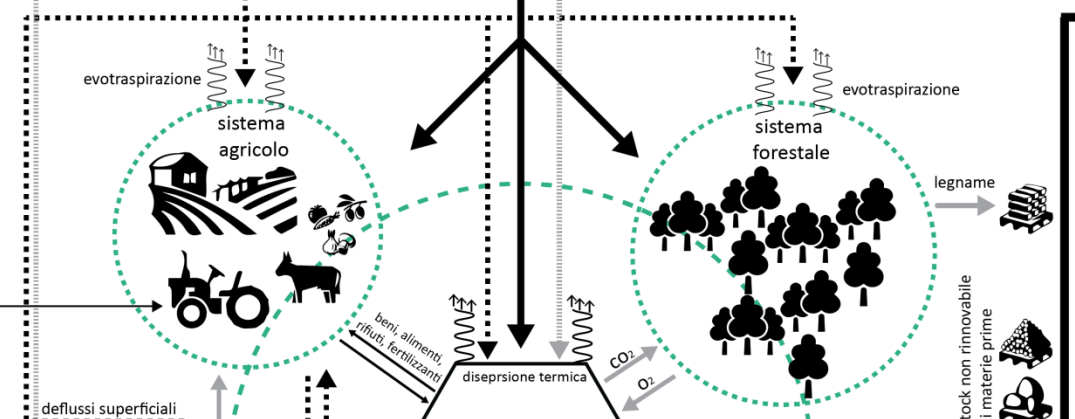
- energia elettrica
- combustibili liquidi
- combustibili gassosi

### FLUSSI DI MATERIA

- beni alimentari
- beni di consumo
- materie prime  
legname, inerti, minerali

### FLUSSI DI INFORMAZIONE

- ricerca
- investimenti e turismo
- lavoro
- idee
- nuove nascite
- immigrazione



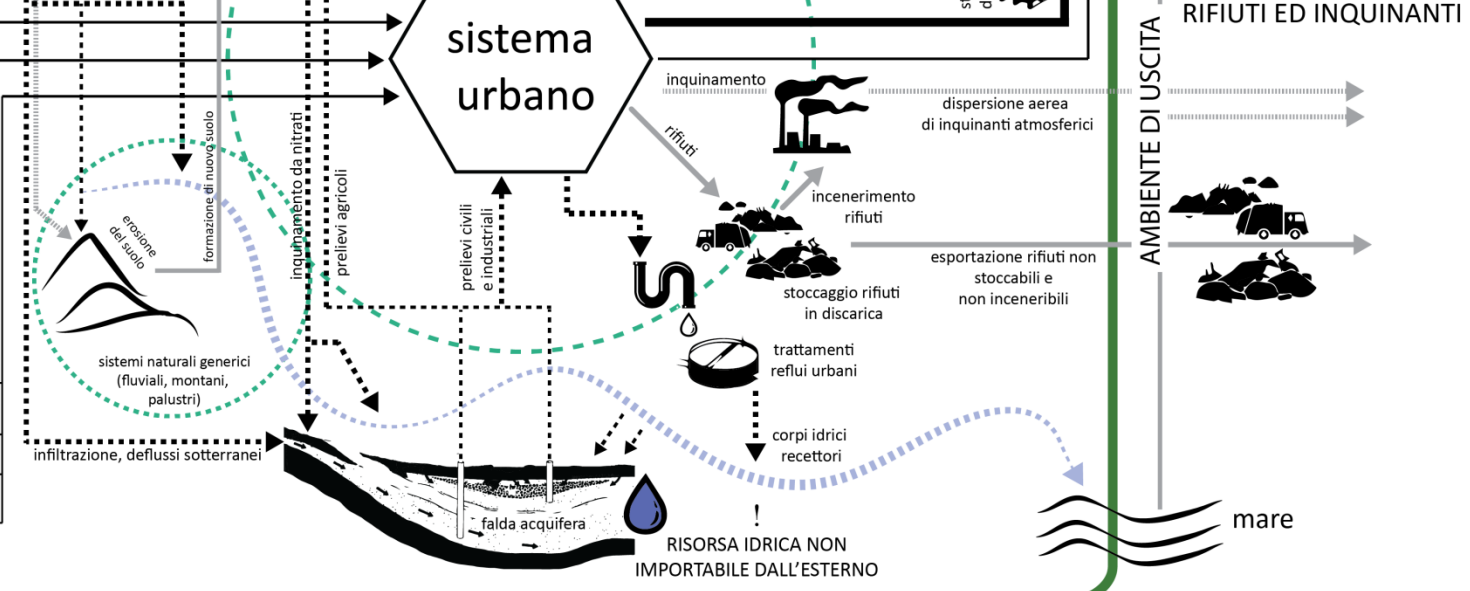
## ESPORTAZIONI

- beni alimentari
- beni di consumo
- materie prime e prodotti lavorati

## FLUSSI MIGRATORI E PENDOLARI

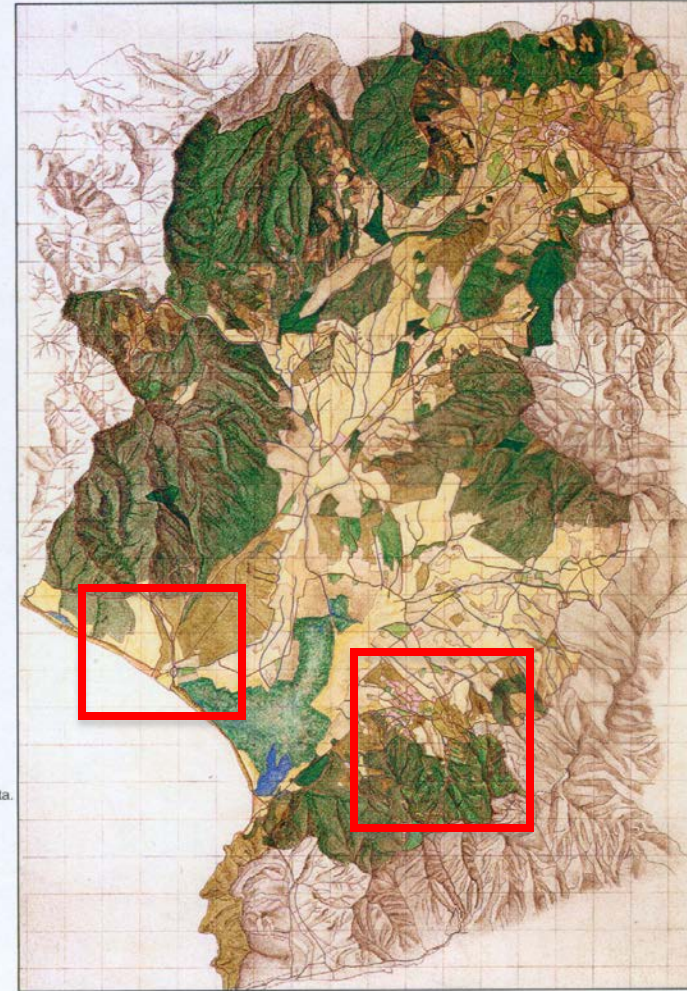
- RIFIUTI ED INQUINANTI

AMBIENTE DI USCITA



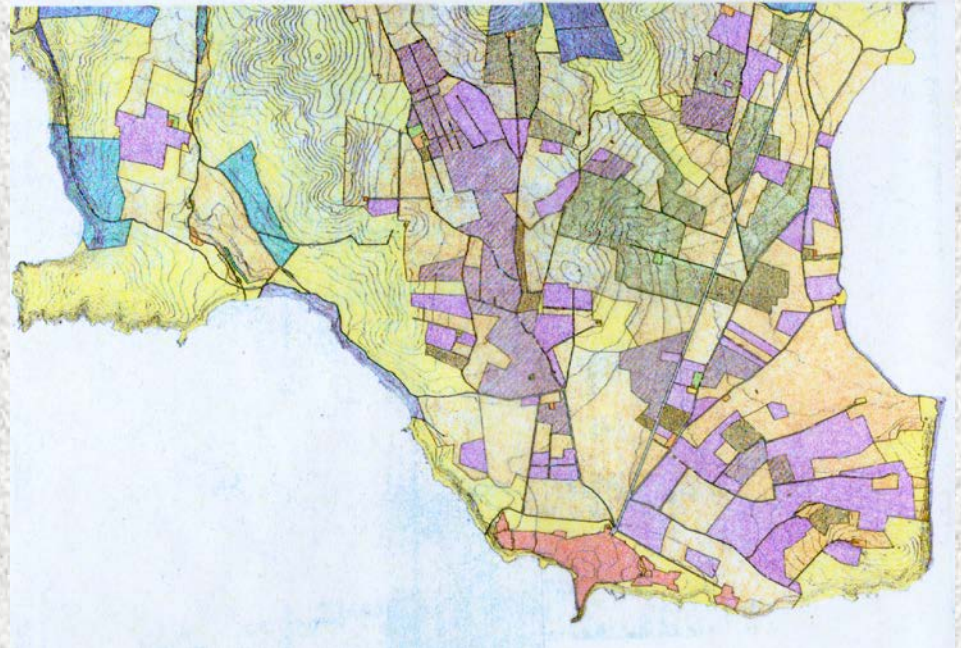


# Esempi dalla storia.



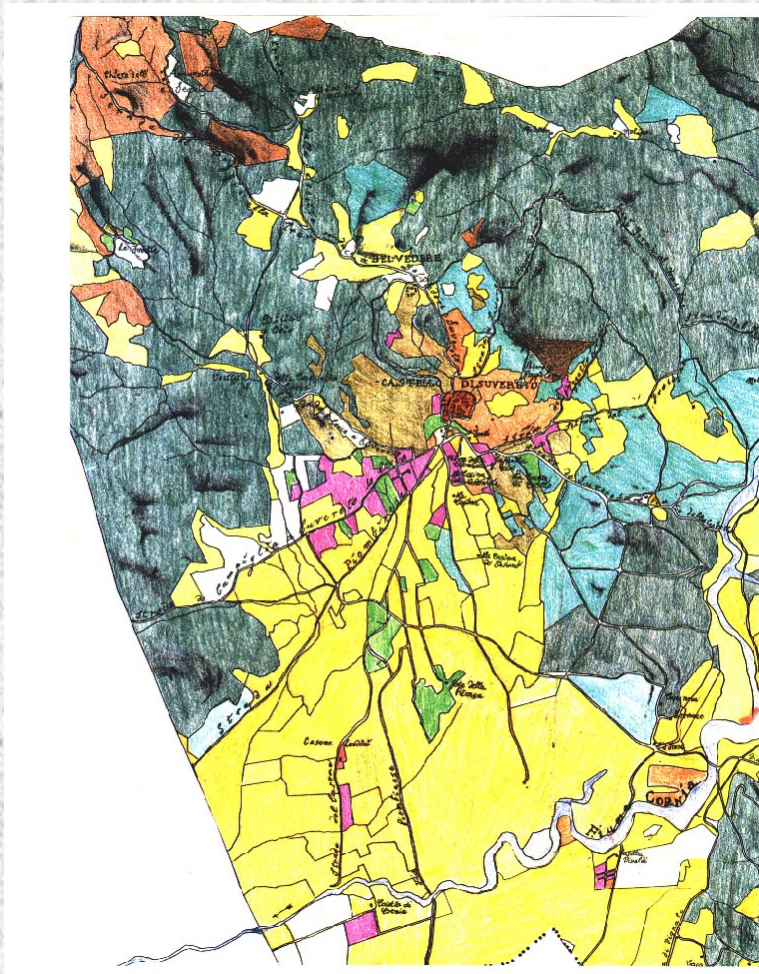


# Esempi dalla storia.





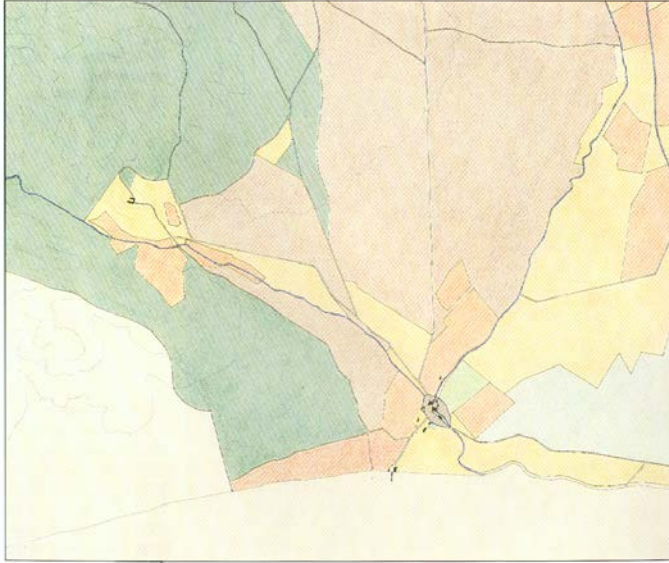
# Esempi dalla storia.



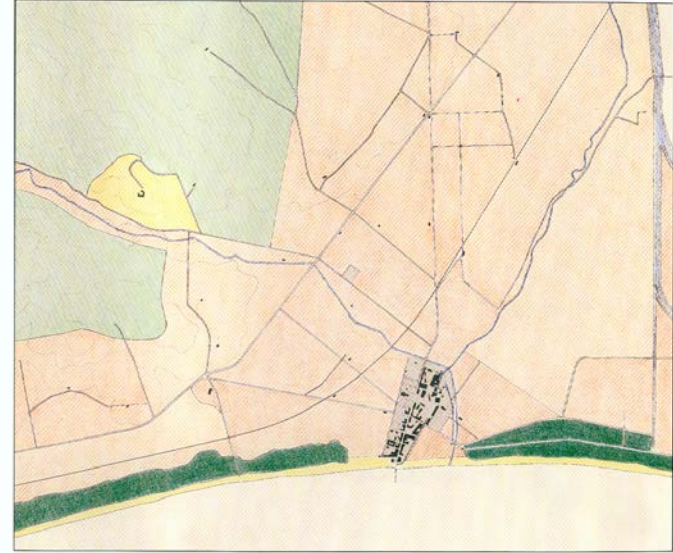


# Esempi dalla storia.

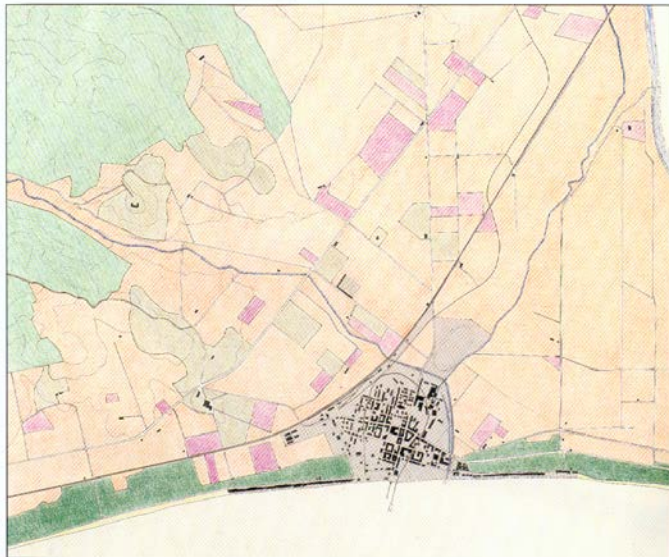
Tav. IV - Follonica: Carta dell'uso del suolo (1822).



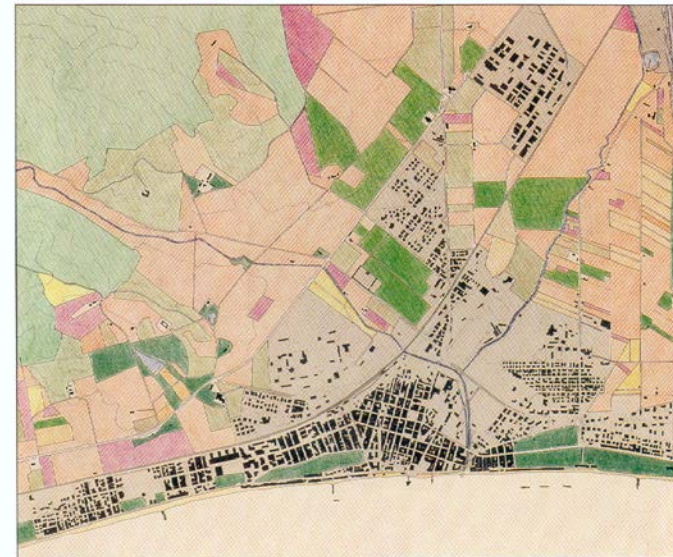
Tav.V - Follonica: Carta dell'uso del suolo (1880).



Tav.VI - Follonica: Carta dell'uso del suolo (1940).

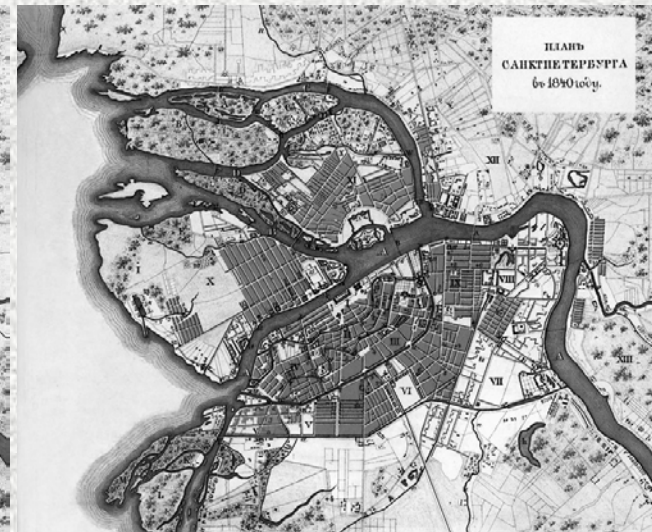
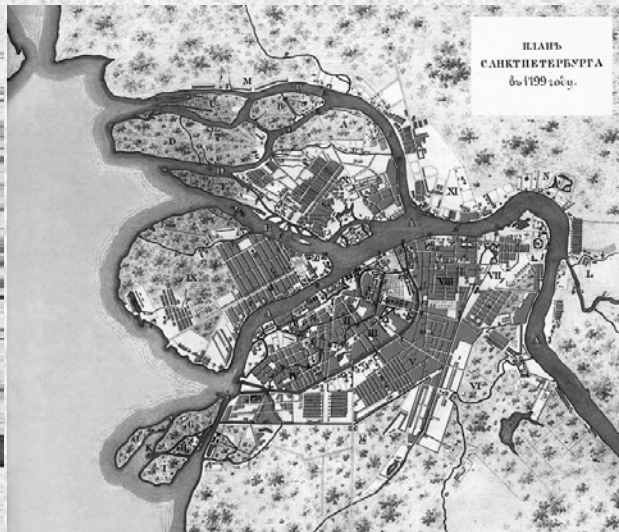
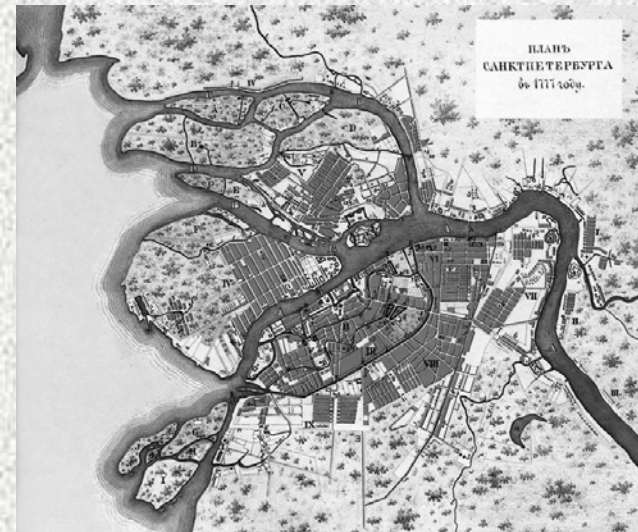
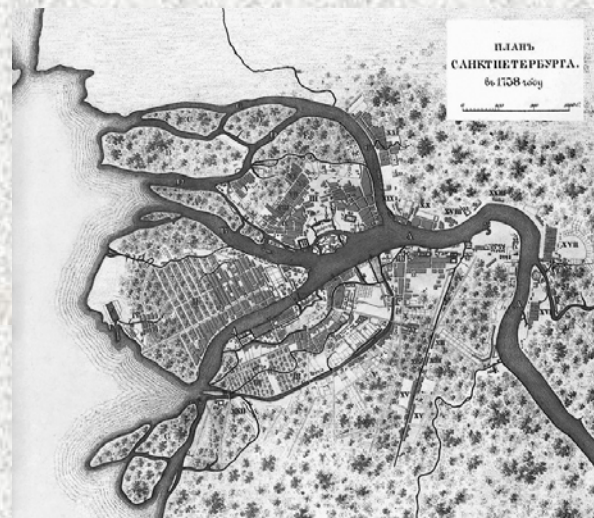
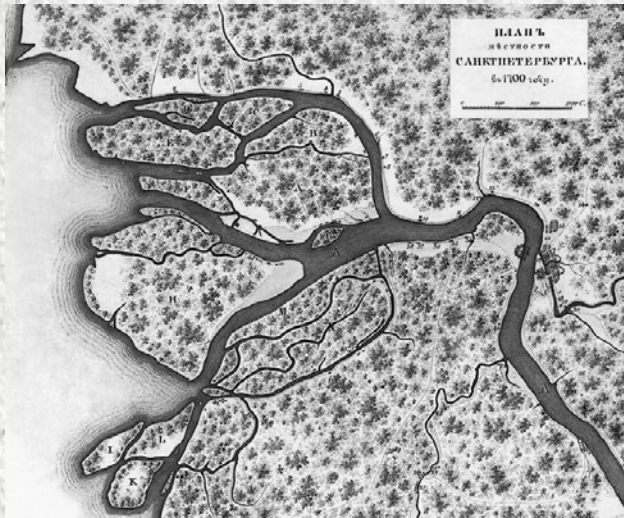


Tav.VII - Follonica: Carta dell'uso del suolo (1980).



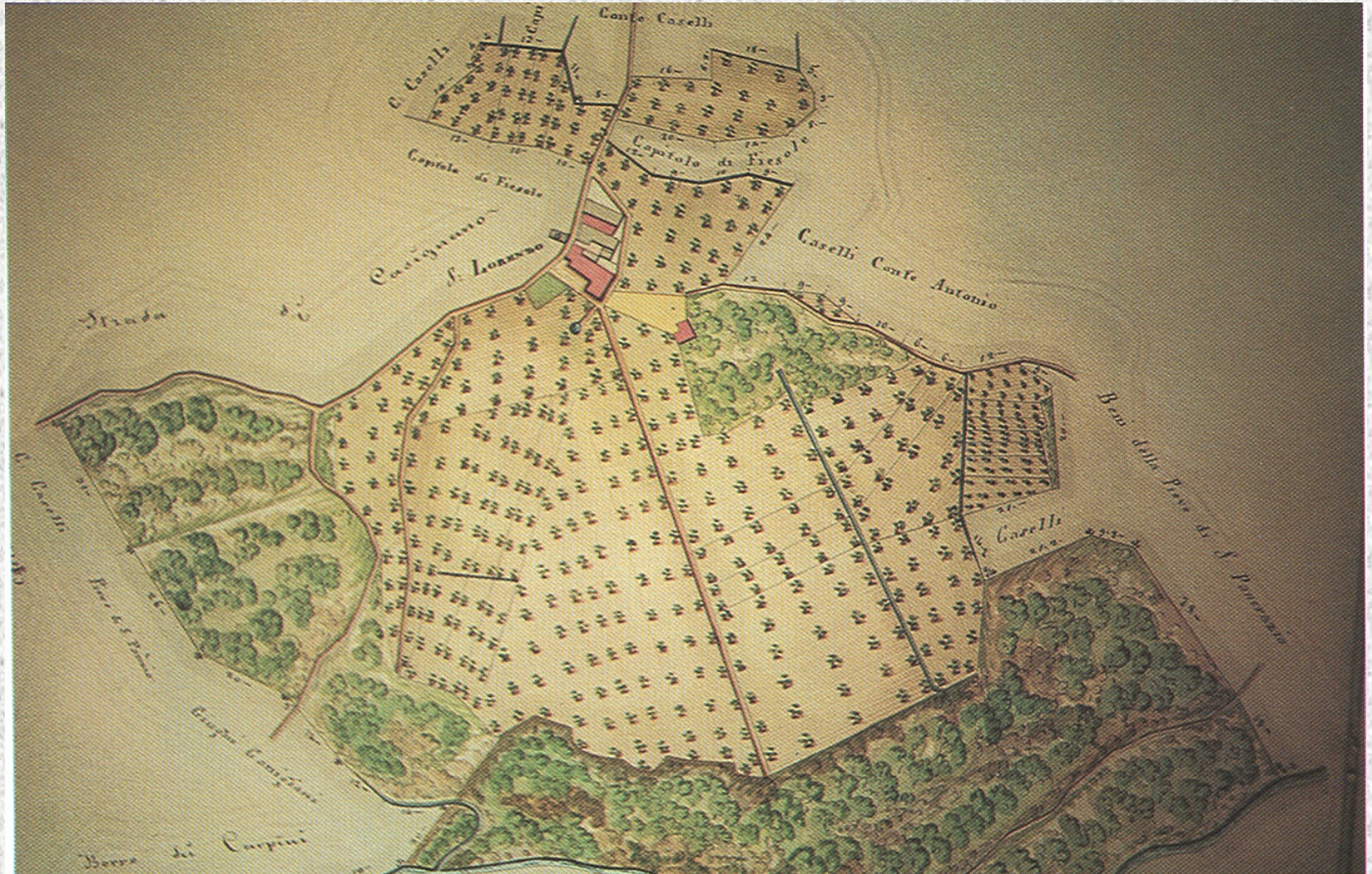


# Esempi dalla storia.



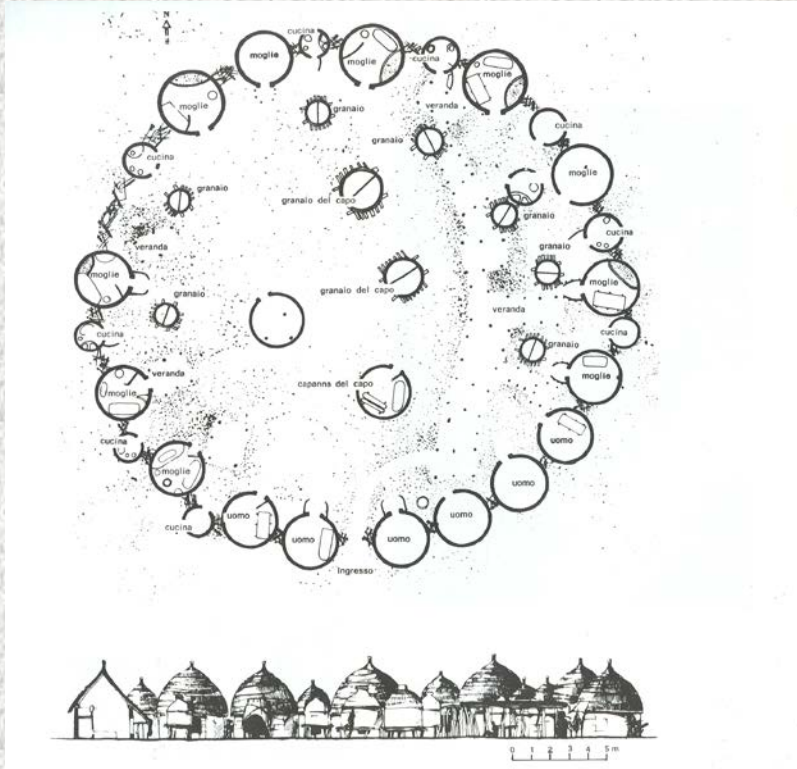


# Multiscalarità dell' insediamento umano e relazioni con l' intorno ambientale

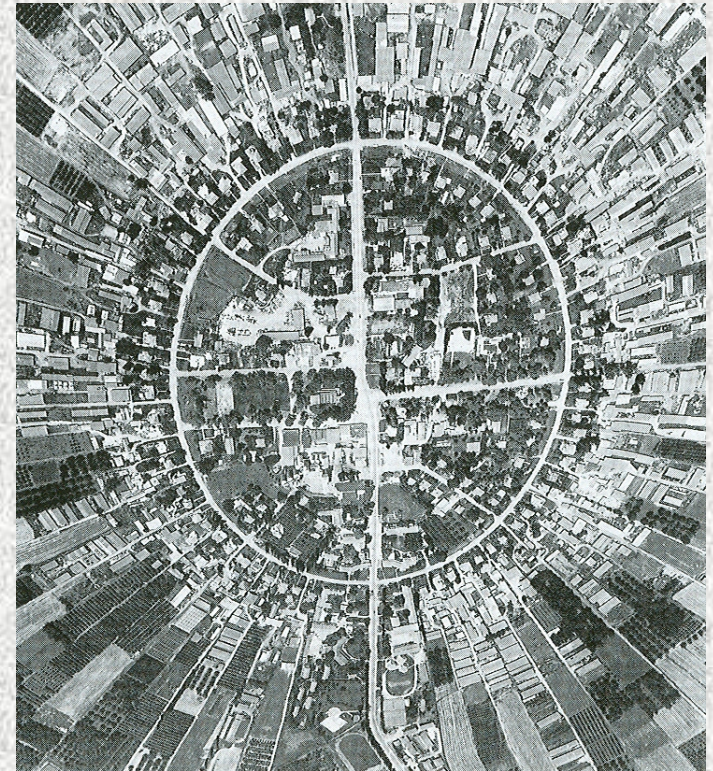




# Multiscalarità dell' insediamento umano e relazioni con l' intorno ambientale



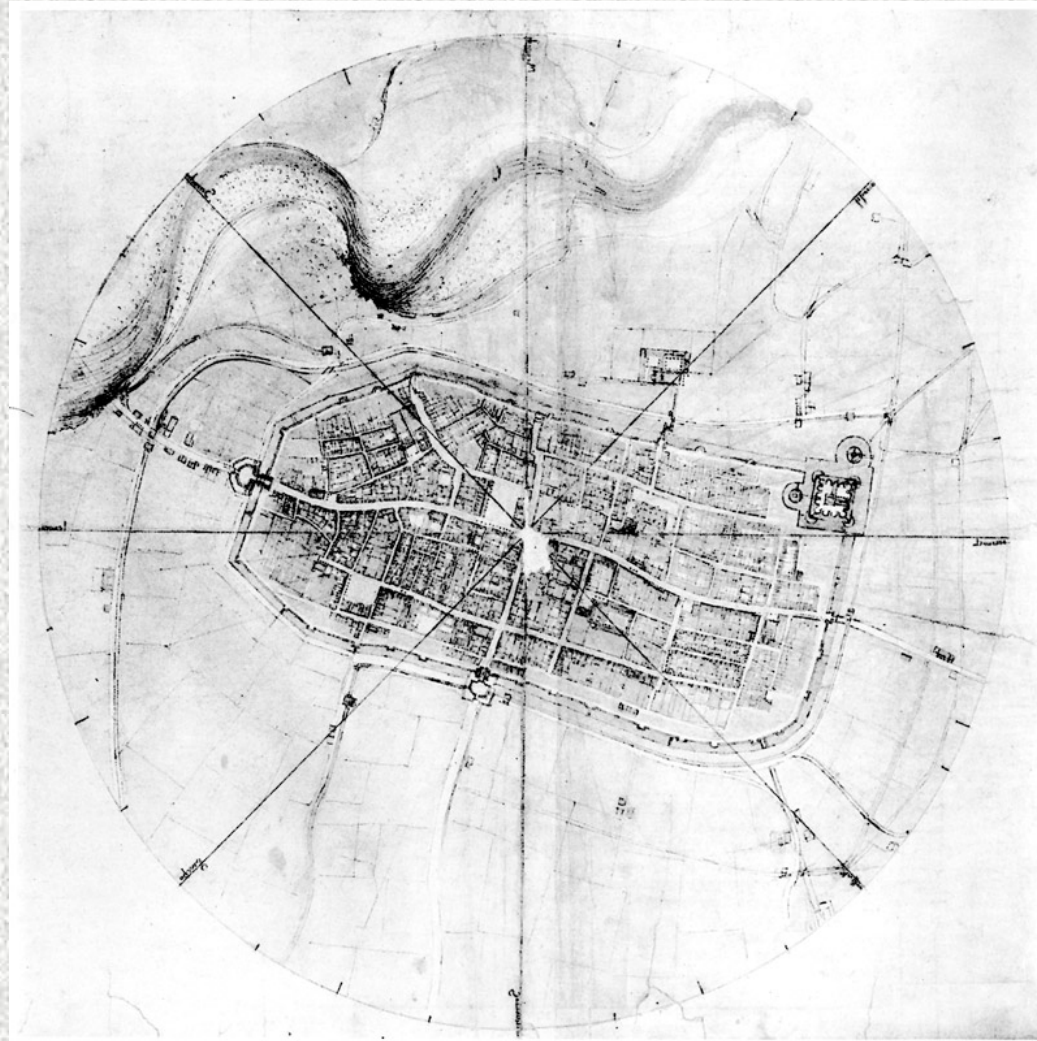
Un villaggio contemporaneo nel Cameroun (Africa)



Namallai



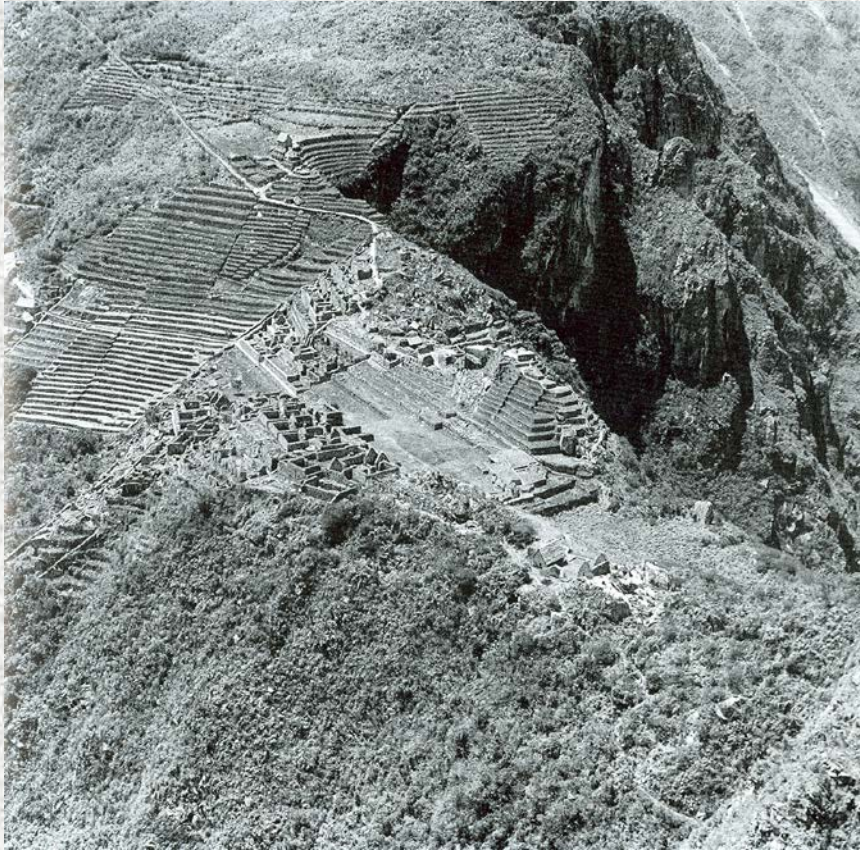
## Multiscalarità dell' insediamento umano e relazioni con l' intorno ambientale



Imola, piano leonardesco, 1502



## Multiscalarità dell' insediamento umano e relazioni con l' intorno ambientale



**Machu Picchu**



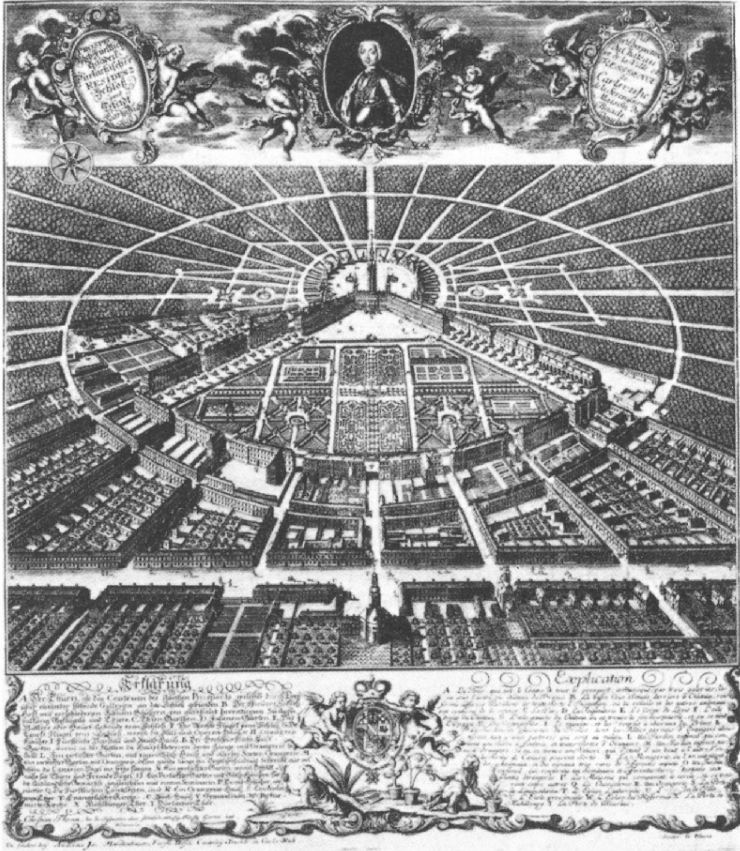
**Orvieto**



# Multiscalarità dell' insediamento umano e relazioni con l' intorno ambientale



Bitonto



Karlsruhe



# Multiscalarità dell' insediamento umano e relazioni con l' intorno ambientale



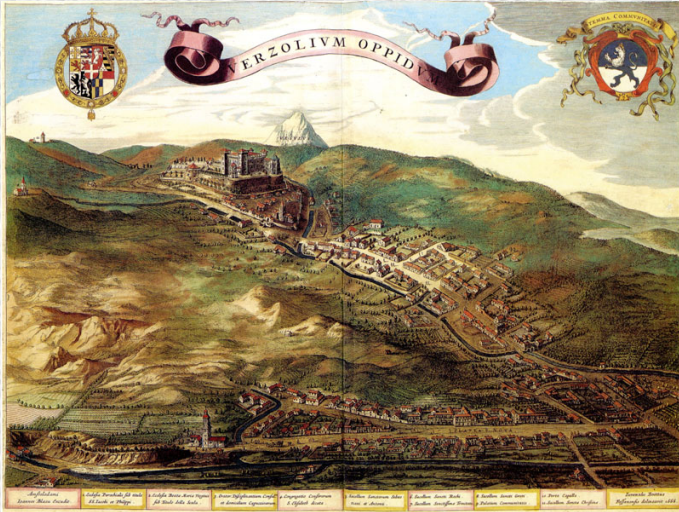
Lucca



Livorno

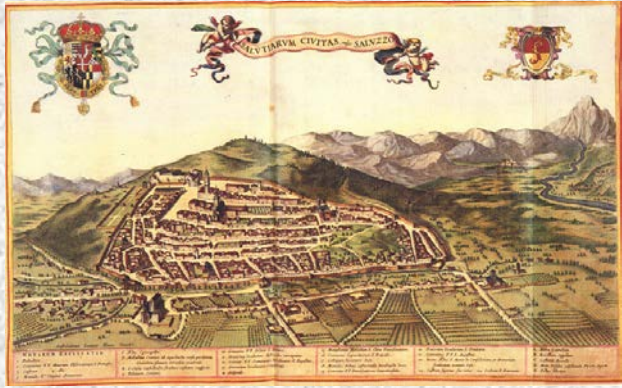
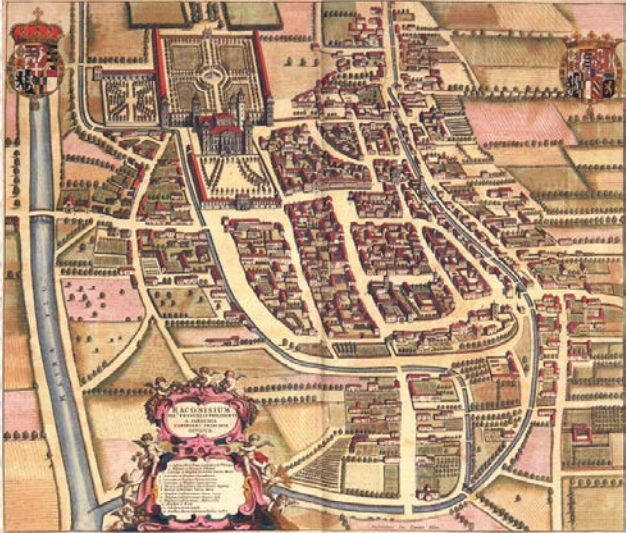


# Multiscalarità dell' insediamento umano e relazioni con l' intorno ambientale



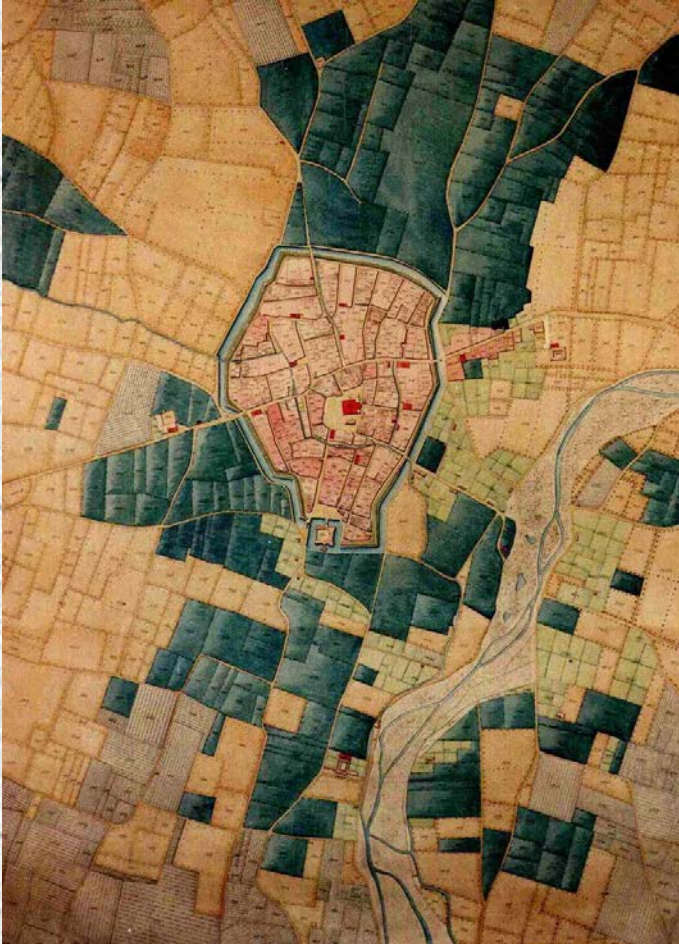


# Multiscalarità dell' insediamento umano e relazioni con l' intorno ambientale

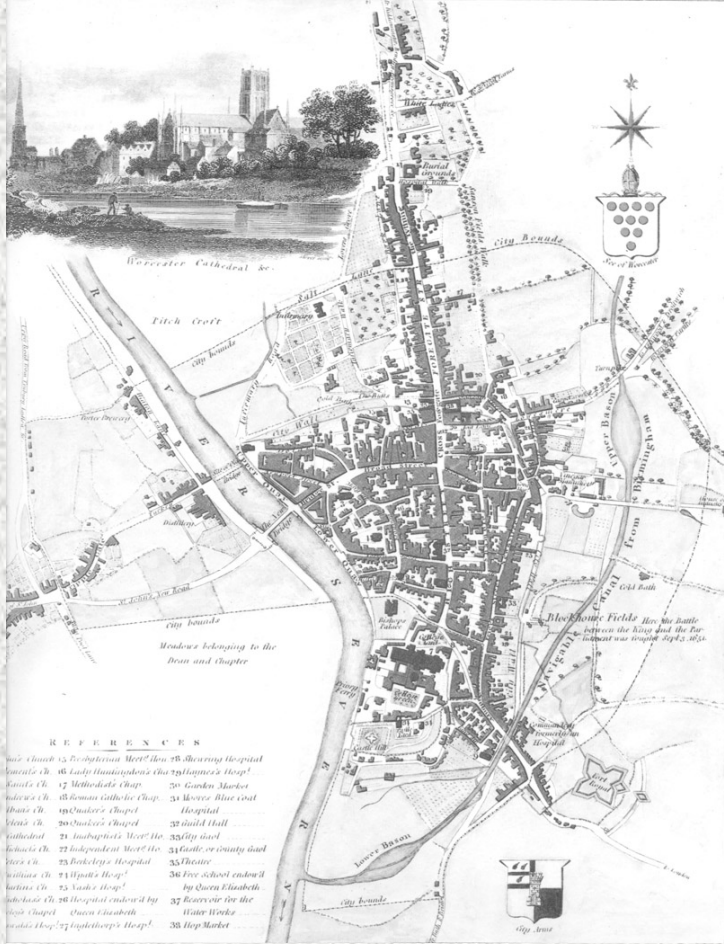




# Multiscalarità dell' insediamento umano e relazioni con l' intorno ambientale



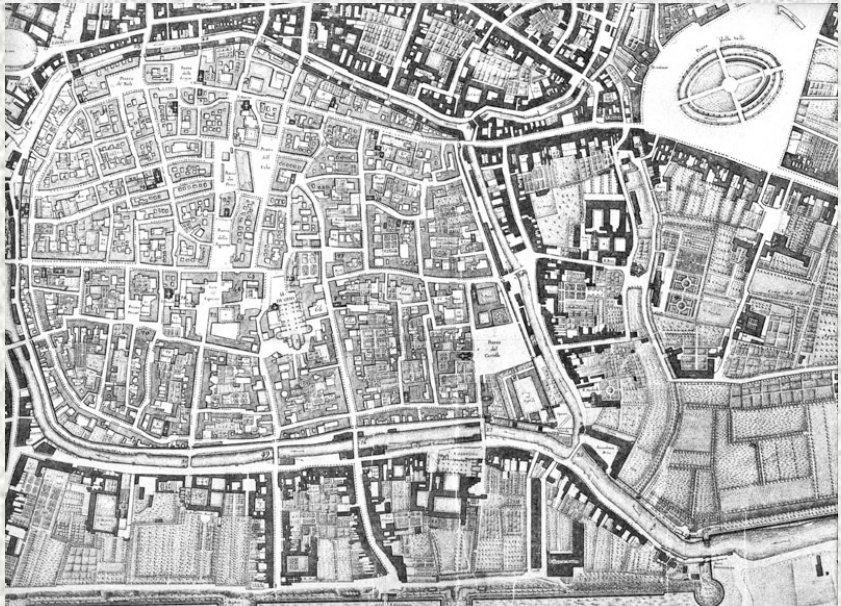
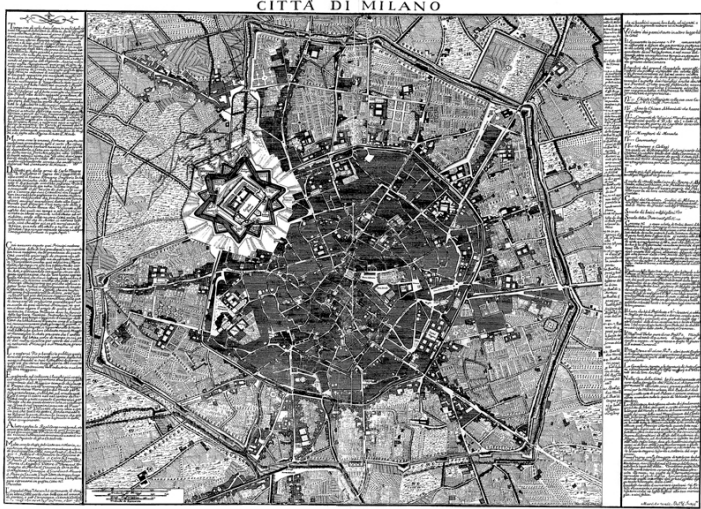
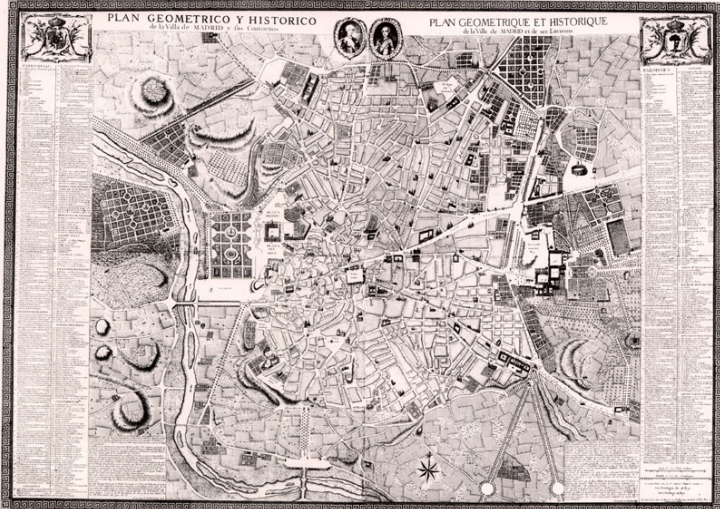
Voghera, pianta catastale, 1723



Worcester, pianta



# Multiscalarità dell' insediamento umano e relazioni con l' intorno ambientale





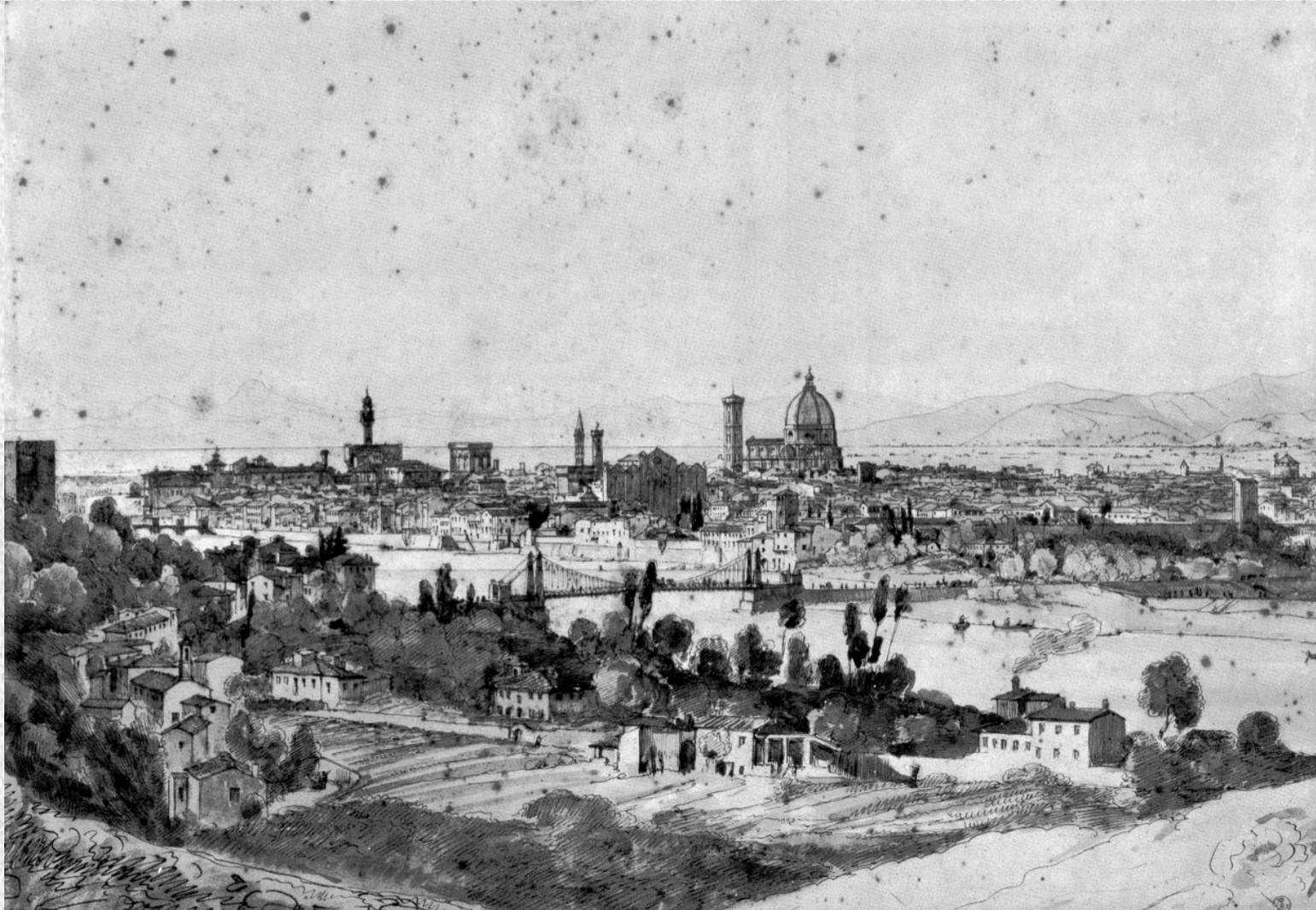
# Multiscalarità dell' insediamento umano e relazioni con l' intorno ambientale



Firenze, pianta, 1837

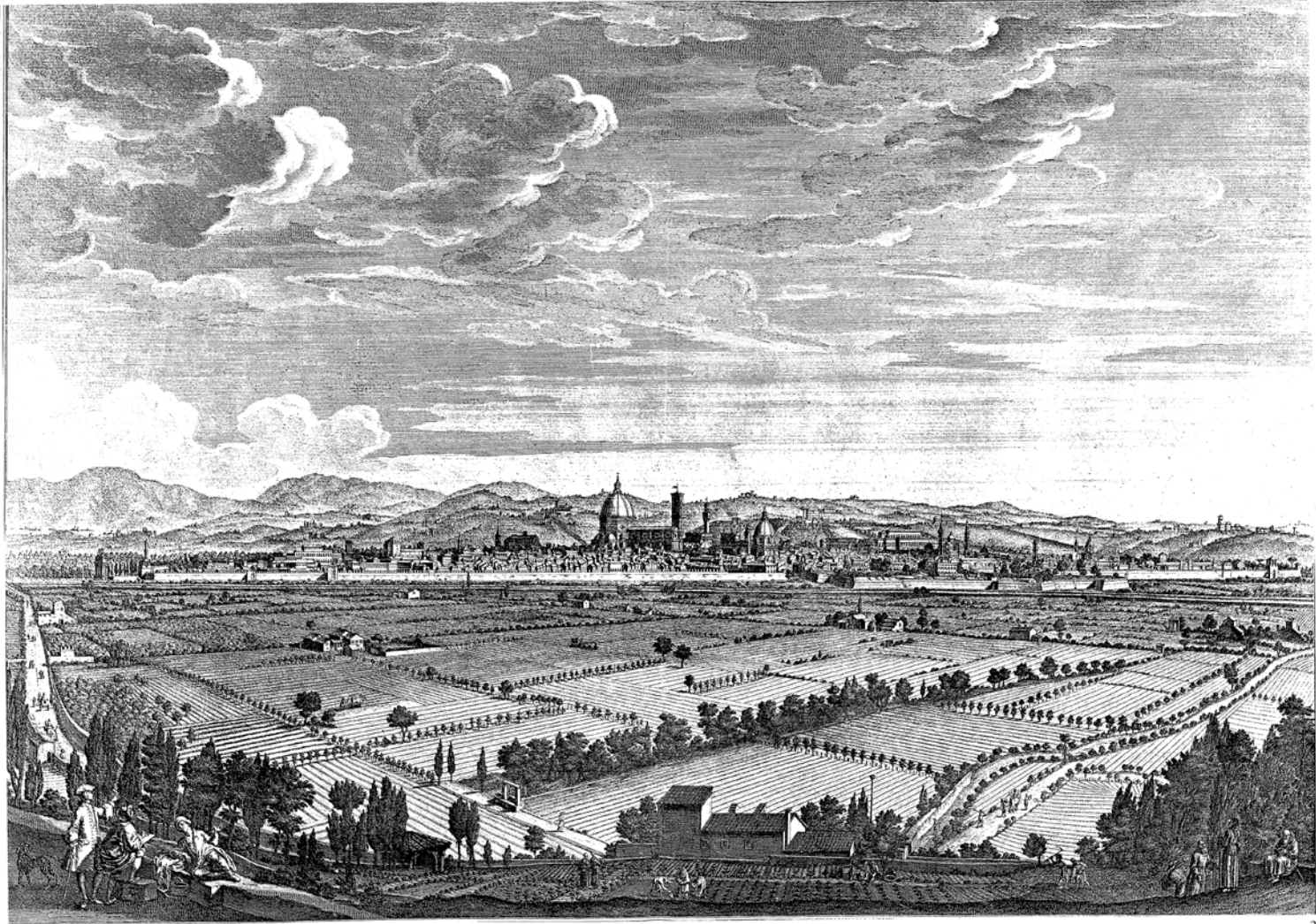


## Multiscalarità dell' insediamento umano e relazioni con l' intorno ambientale





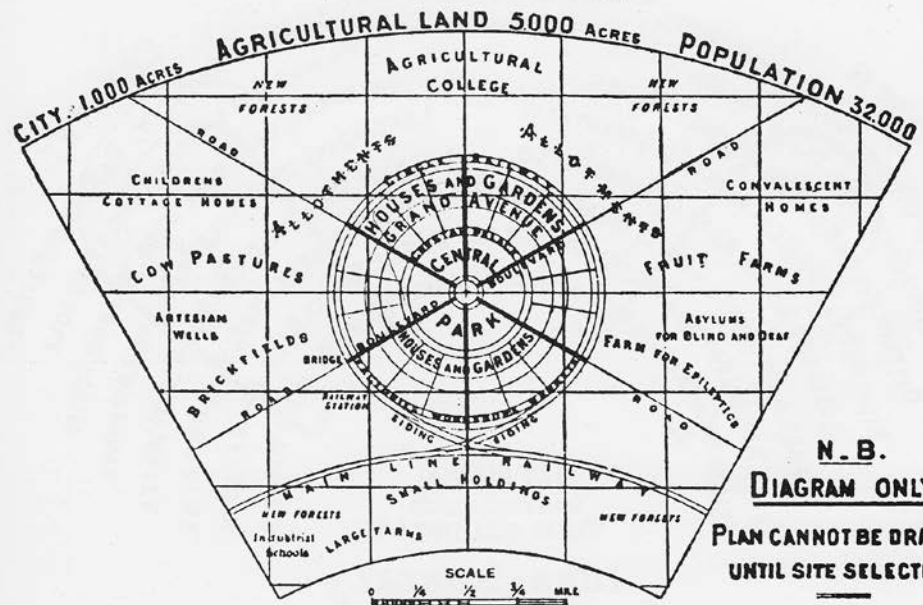
## Multiscalarità dell' insediamento umano e relazioni con l' intorno ambientale





- N°2 -

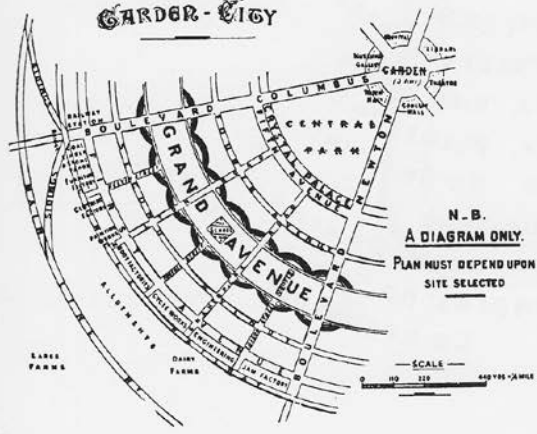
# GARDEN-CITY



**N. B.**  
**DIAGRAM ONLY.**  
 PLAN CANNOT BE DRAWN  
 UNTIL SITE SELECTED

WARD AND CENTRE  
**GARDEN-CITY**

N°3

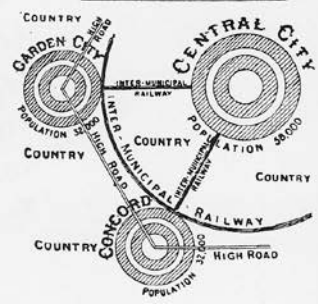


**N. B.**  
**A DIAGRAM ONLY.**  
 PLAN MUST DEPEND UPON  
 SITE SELECTED

N°5.

## DIAGRAM

ILLUSTRATING CORRECT PRINCIPLE  
 OF A CITY'S GROWTH - OPEN COUNTRY  
 EVER NEAR AT HAND, AND RAPID  
 COMMUNICATION BETWEEN OFF-SHOOTS



**Ebenezer Howard, i diagrammi della Città Giardino**



# Riferimenti bibliografici:

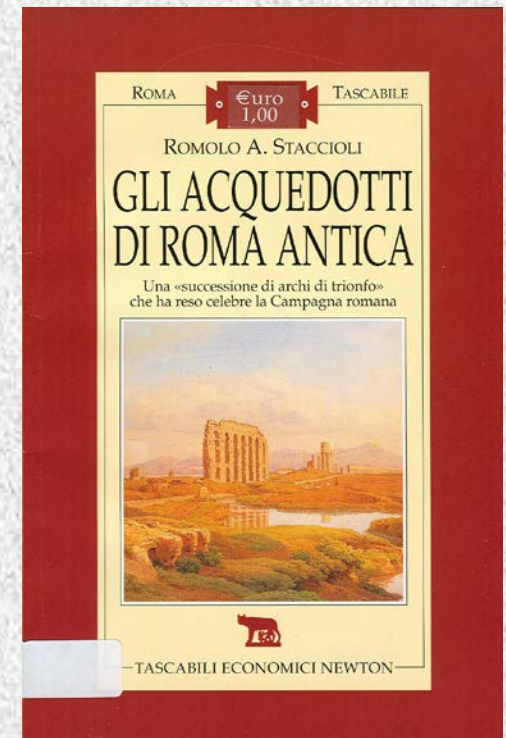
- (- Saragosa C., “L’ Ecosistema Territoriale e la sua base ambientale”, in Magnaghi A. (a cura di), *Rappresentare i luoghi. Metodi e tecniche*, Alinea Editrice, Firenze, 2001, pag. 59-79.
- Saragosa C., *L’insediamento umano. Ecologia e sostenibilità*, Donzelli Editore, Roma, 2005, pag. 13-50, 89-138, 183-221).

# **Infrastrutture ed elementi di connessioni fra città e territorio**

*Gli acquedotti*



# L'acqua di Roma

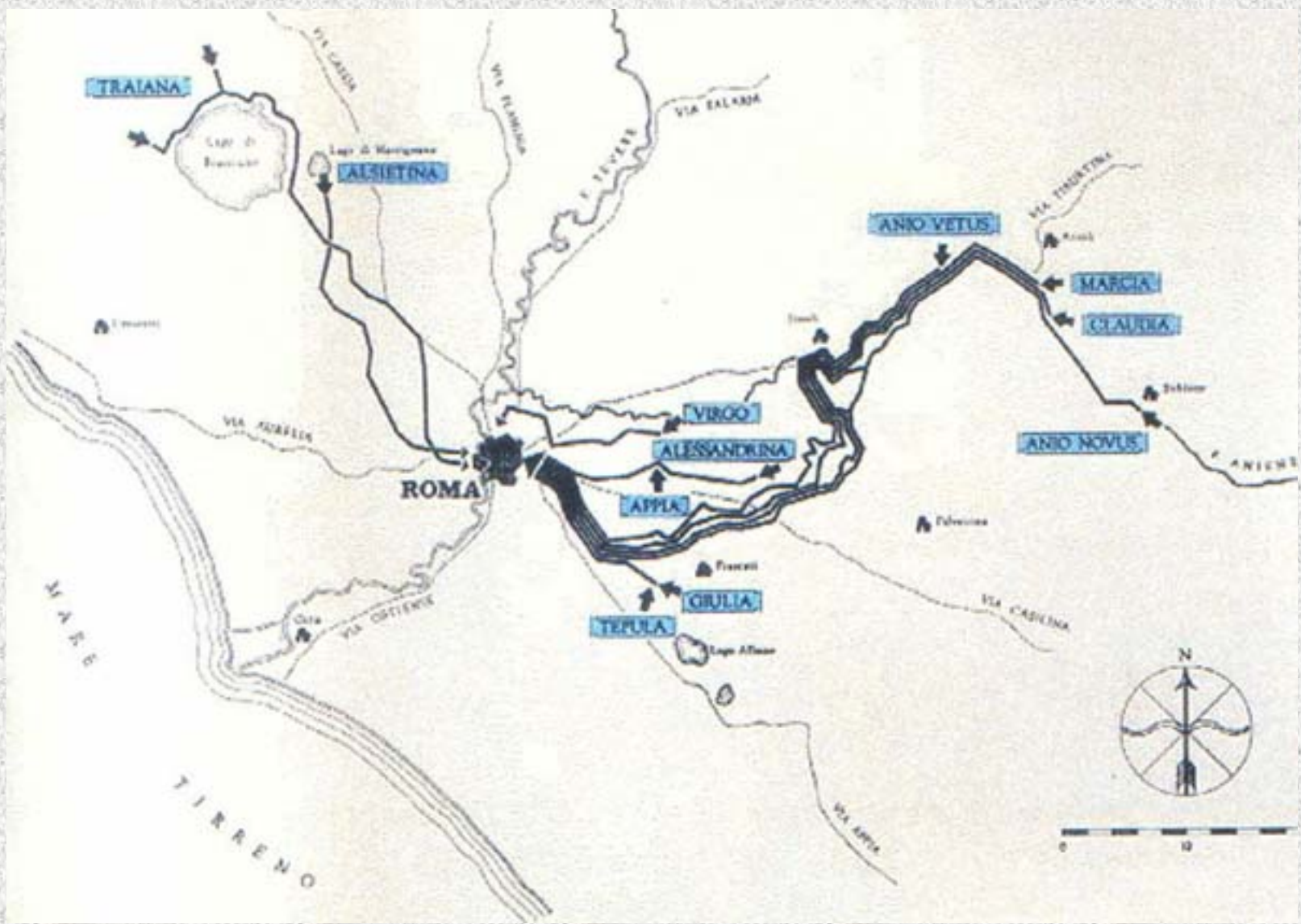




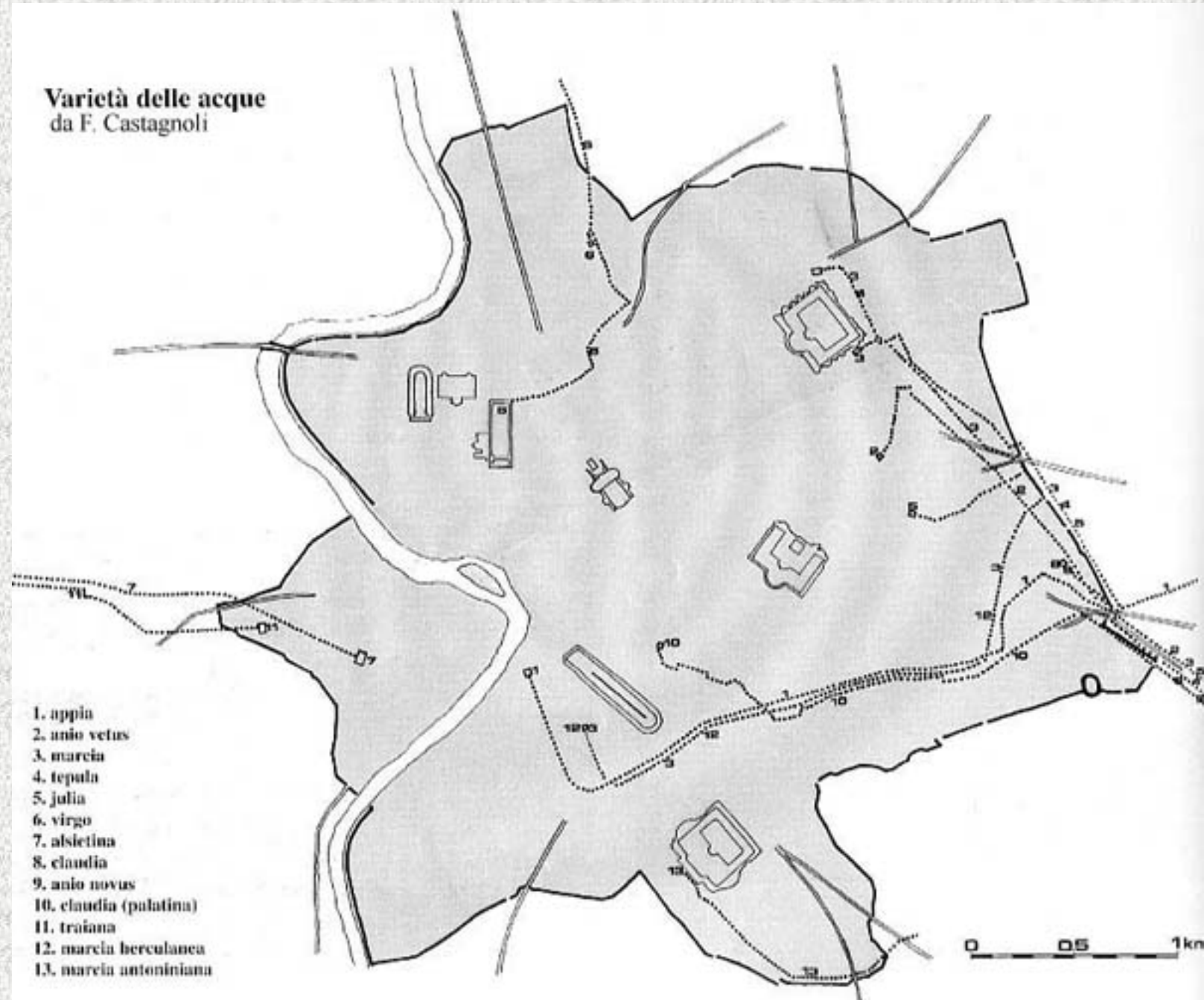
## Tabella riassuntiva degli acquedotti antichi a Roma

Nome dell'acquedotto	Anno di costruzione	Portata giornaliera alla sorgente	Lunghezza
Aqua Appia	312 a.C.	841 quinarie - 34.000 mc 1.825 quinarie - 75.000 mc	11.190 passi
Anio Vetus	272 - 270 a.C.	2.362 quinarie	43.000 passi
Aqua Marcia	145 a.C.	4600 187.000 mc	61.710 passi
Aqua Tepula	125 a.C.	16.000 - 18.000 mc	
Aqua Julia	33 a.C.	48.000 - 50.000 mc	15.426 passi
Aqua Virgo	19 a.C.	100.000 - 103.000 mc	14.105 passi
Aqua Alsietina	2 a.C.	16.000 mc	22.172 passi
Anio Novus	38 - 52 d.C.	190.000 mc	58.700 passi
Aqua Claudia	38 - 52 d.C.	184.000 - 196.000 mc	46.606 passi
Aqua Traiana	109 d.C.	118.000 mc	32 km
Aqua Alexandrina	226 d.C.	22.000 mc	20 km





**Varietà delle acque**  
da F. Castagnoli











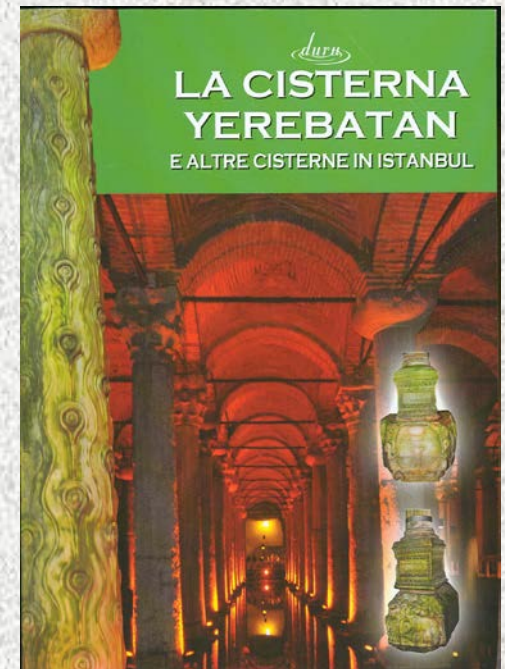








# L'acqua di Istanbul











N

Image © 2010 DigitalGlobe

© 2009 Google

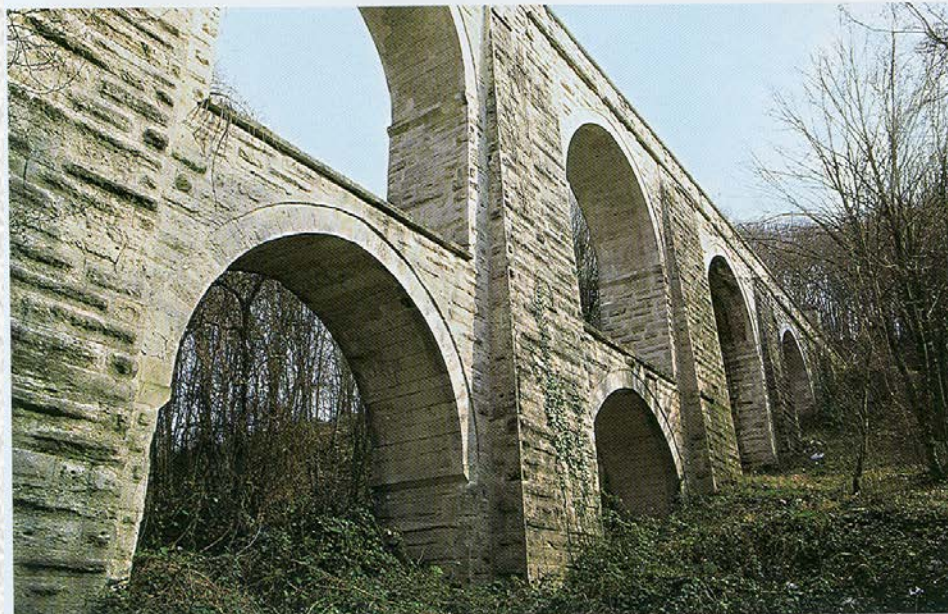
Data di acquisizione delle immagini: 10 Gen 2007 41°00'55.31" N 28°57'23.07" E 0 m elev

793 m Alt





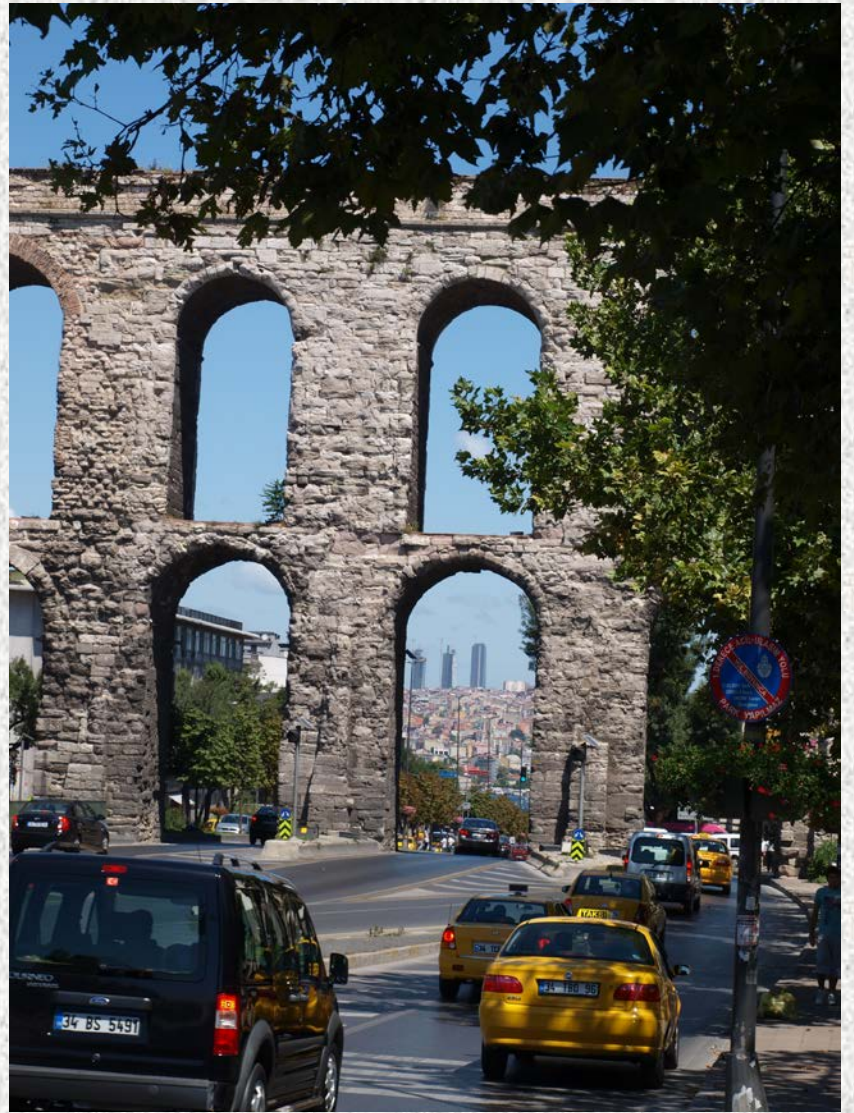
*L'Acquedotto di Uzunkeher*



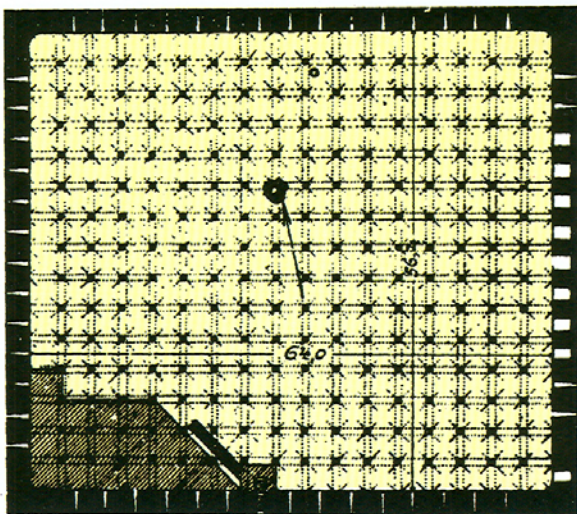
*L'Acquedotto di Kovukkeher*



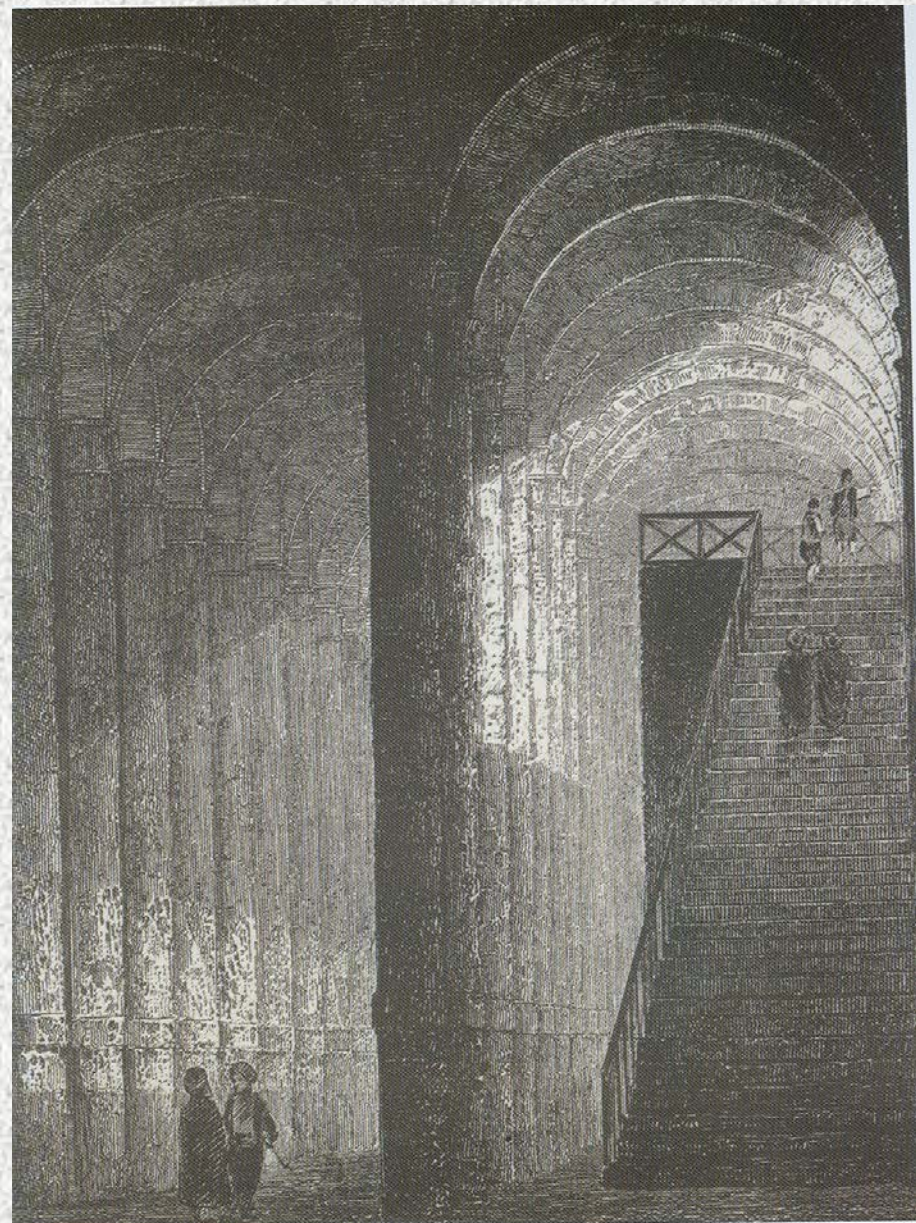
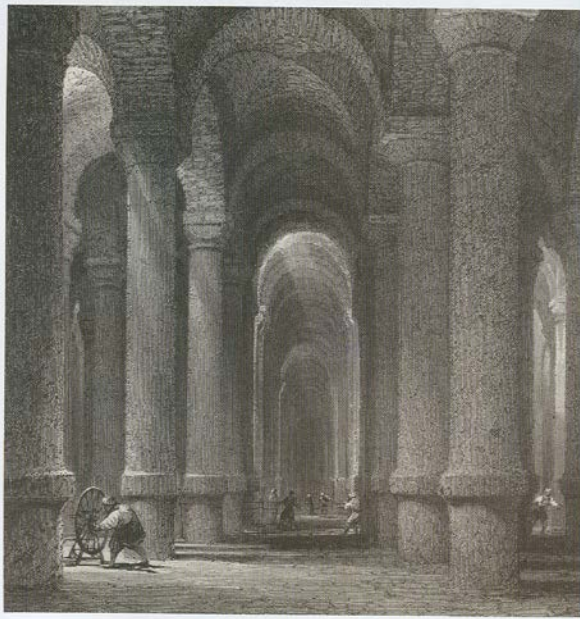








*Il piano della cisterna Binbirdirek*



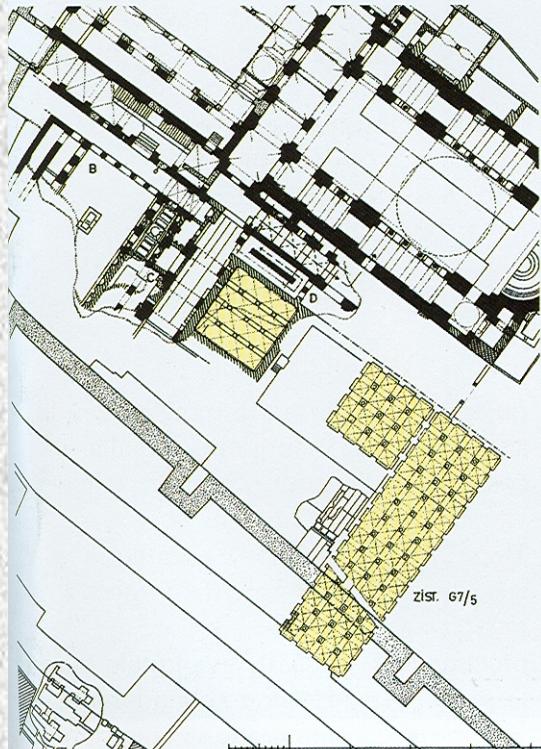
*La cisterna Binbirdirek su due antica incisione*



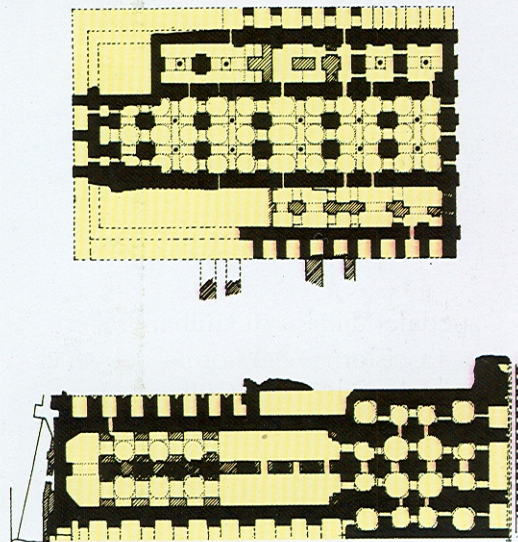


*Una veduta dall'interno della Binbirdirek Cisterna*





*le cisterne di Hagia Eirene*



*La Cisterna del Palazzo di Mangalar*



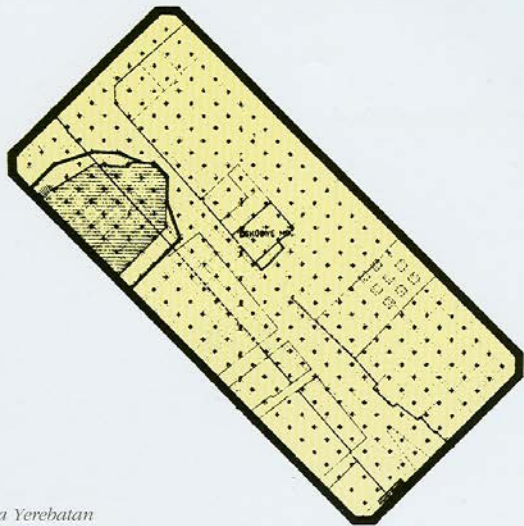


Image © 2010 DigitalGlobe

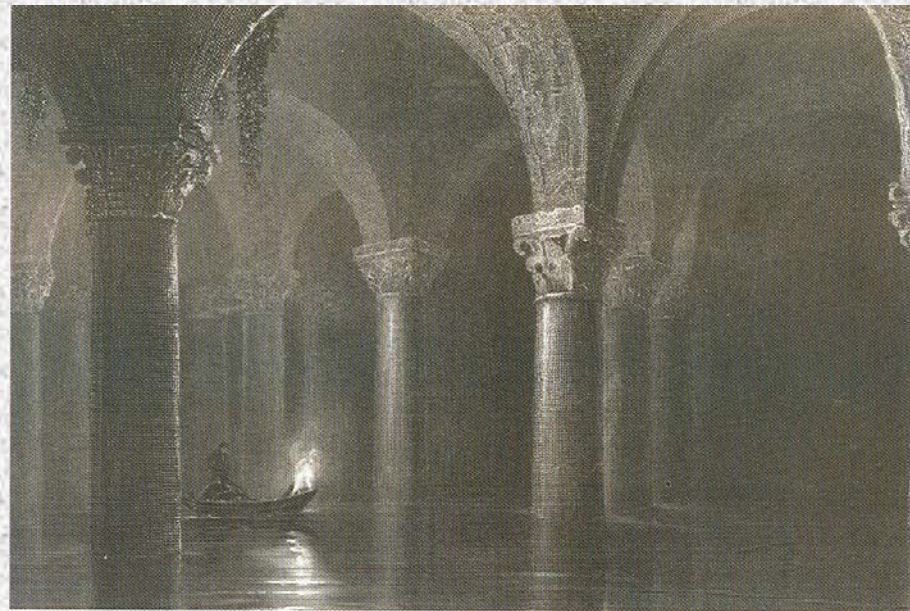
2009 Google

Data di acquisizione delle immagini: 10 Gen 2007 41°00'26.81" N 28°58'38.47" E 0 m elev 811 m Alt





*Il plano della cisterna Yerebatan*

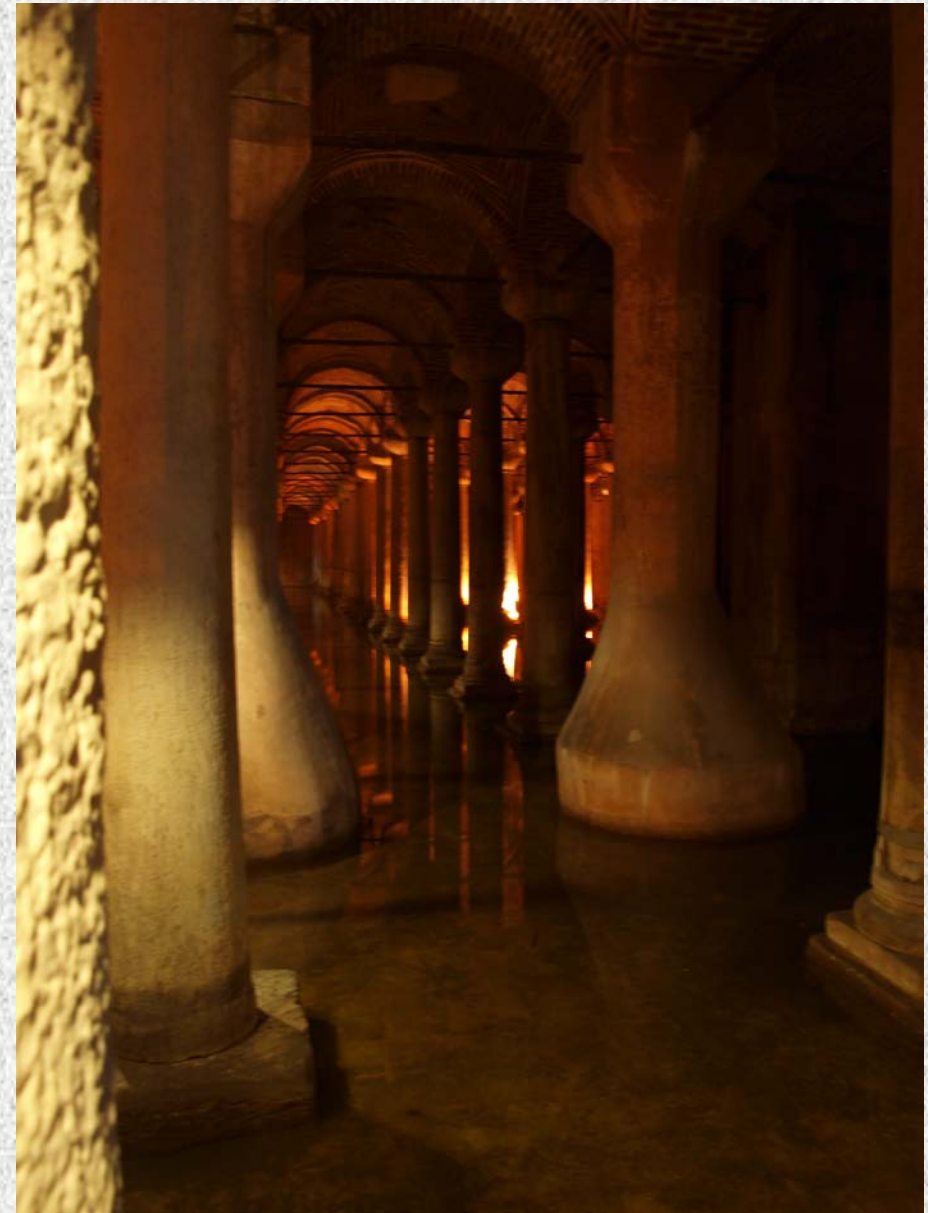


*La cisterna Yerebatan su una antica incisione*







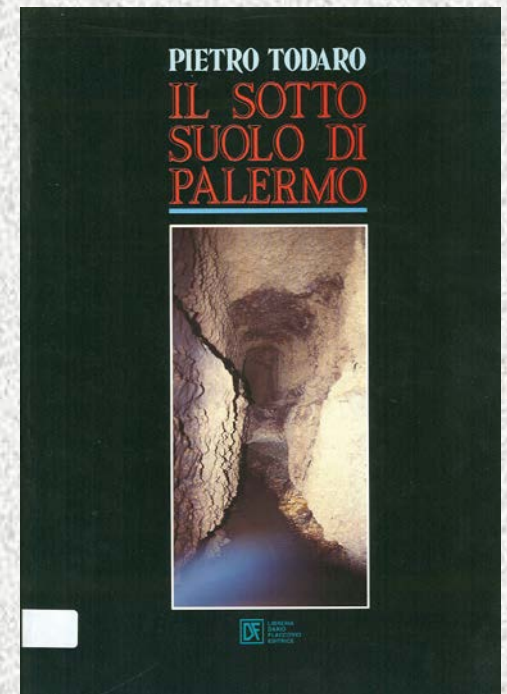








# L'acqua di Palermo











N

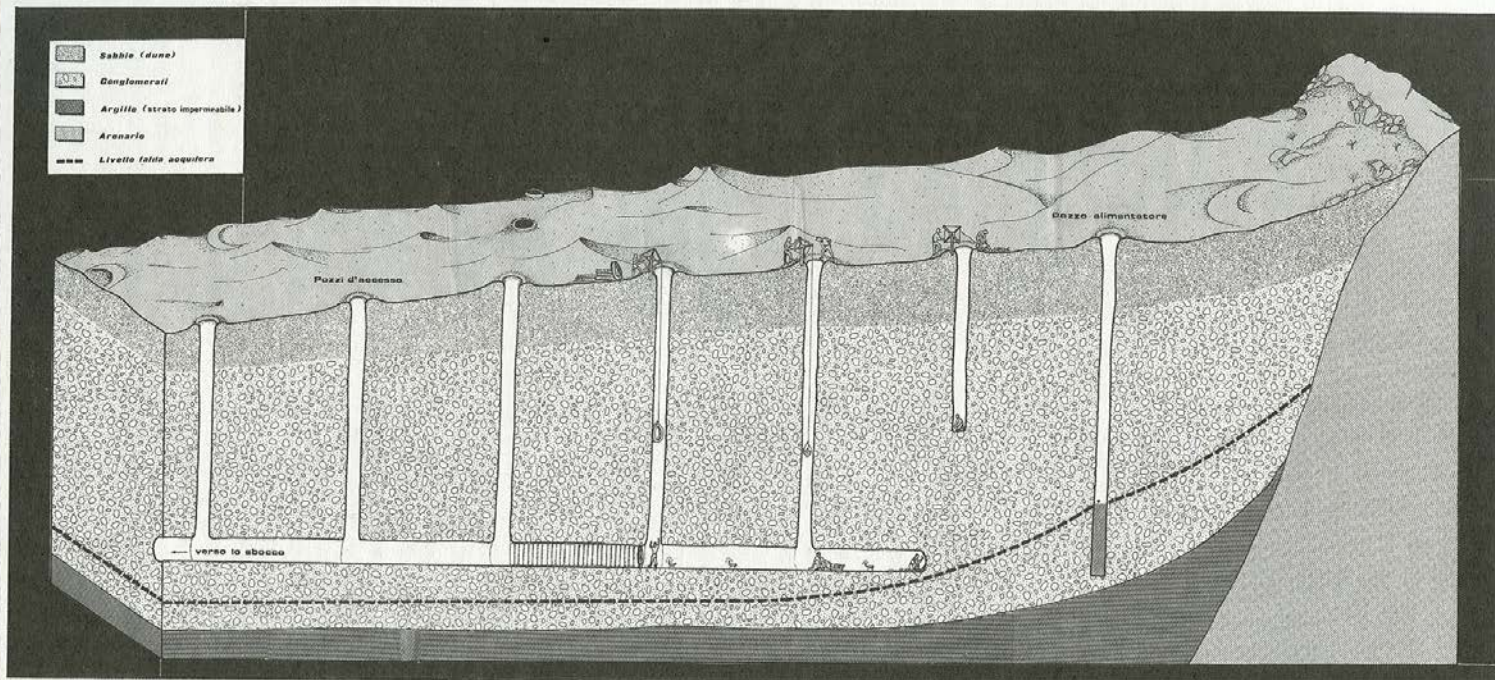
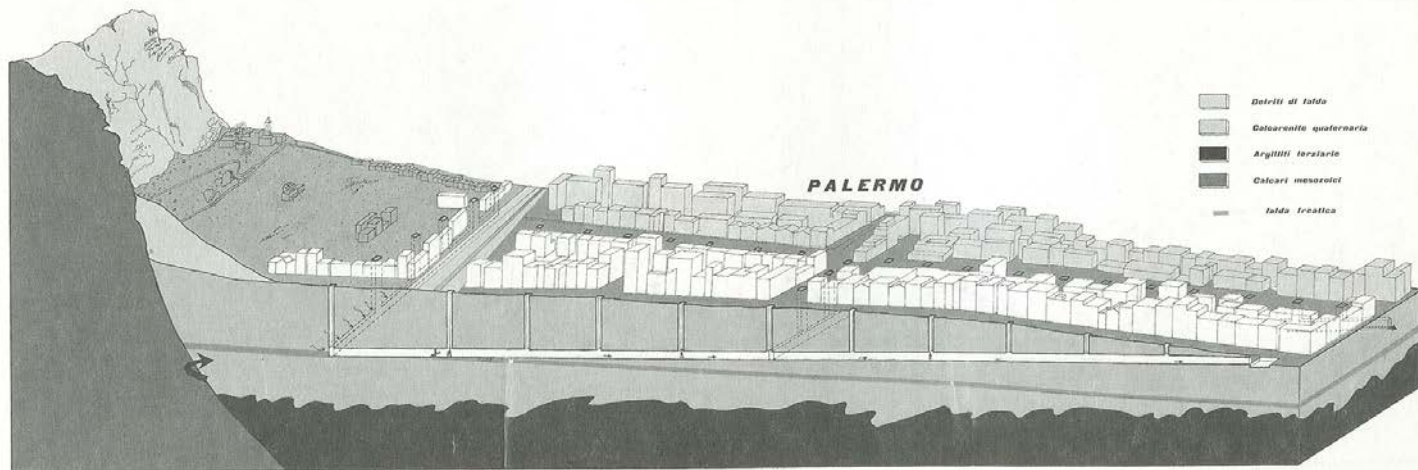
Google

Data di acquisizione delle immagini: 3 Ott 2007 38°06'56.23" N 13°21'40.95" E 0 m elev

2.29 km Alt

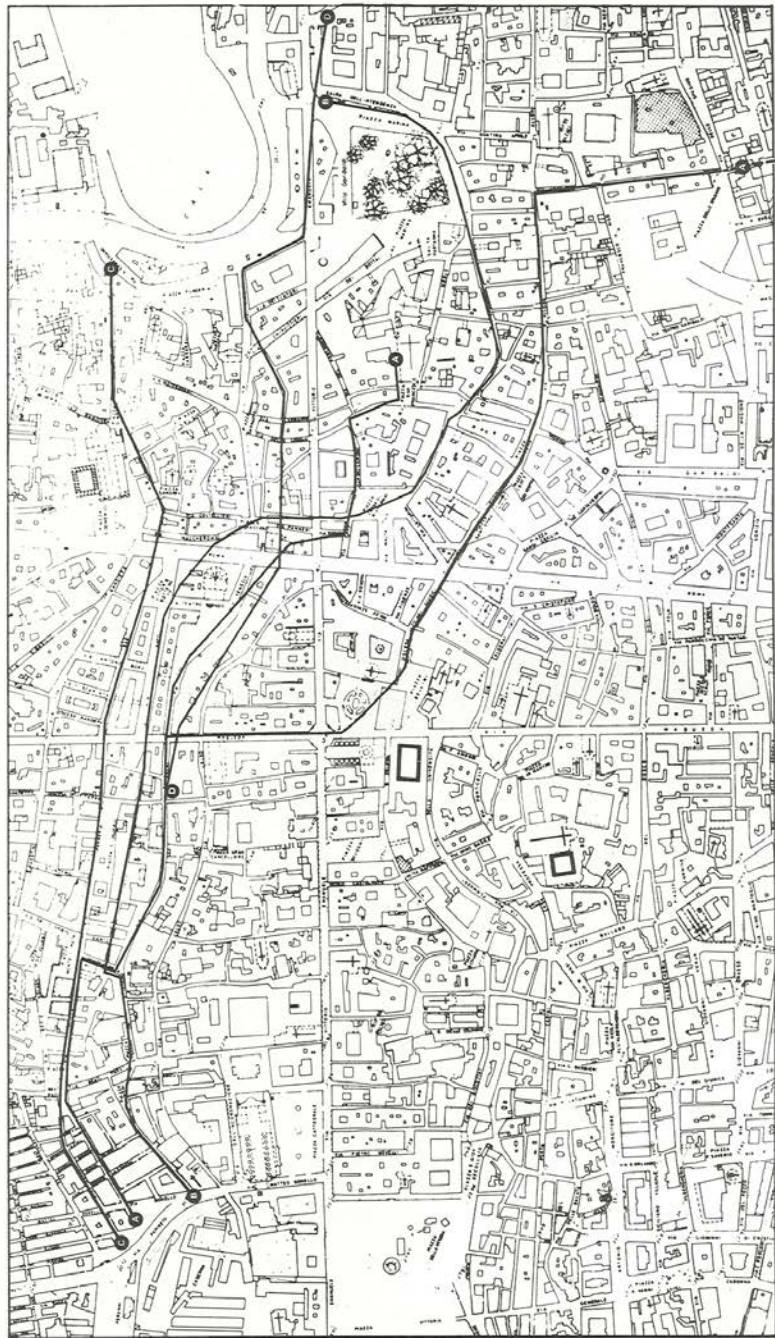






**Fig. 11** - Stereogramma di un qanat delle zone aride iraniane durante lo scavo della parte terminale. Le pareti franose del tunnel vengono sostenute da grandi anelli di terracotta. Le tre lampade ad olio permettono al *muqanni* di mantenere l'allineamento dell'asse del *qanat* sino all'ultimazione della condotta che coincide con il raggiungimento del pozzo principale che alimenterà l'acquedotto. (Da Wulff, modificato).





MACELLO

**Fig. 18/b** - I percorsi degli antichi acquedotti-qanat di Palermo.

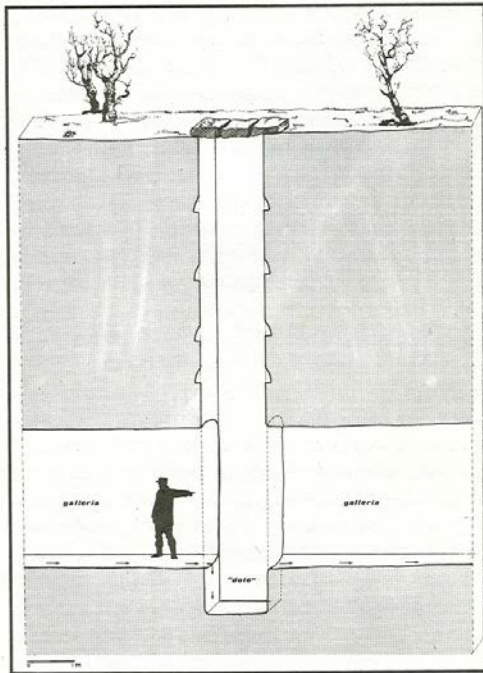
**A** Largo S. Rosalia, via Gioiamia, piazza S. Cosimo, piazza Monte Pietà, via Calderai, dove si biforca in due rami: uno segue via Tornieri, via dei Cartari, chiesa di S. Francesco, l'altro percorre via Maqueda, piazza Pretoria, discesa dei Giudici, piazza S. Anna, via Vetreria, Spasimo, taglia via Lincon per sboccare al vecchio macello.

**B** Largo S. Rosalia, via Gioeni, via Balsamo, via S. Giannuzzo, piazza S. Isidoro, via Judica, piazza Monte Pietà, via Cannello, via delle Api, piazza Nuova, via Formai, via Mezzani, via Visita Poveri, via Calascibetta, via Lungarini, Dogana.

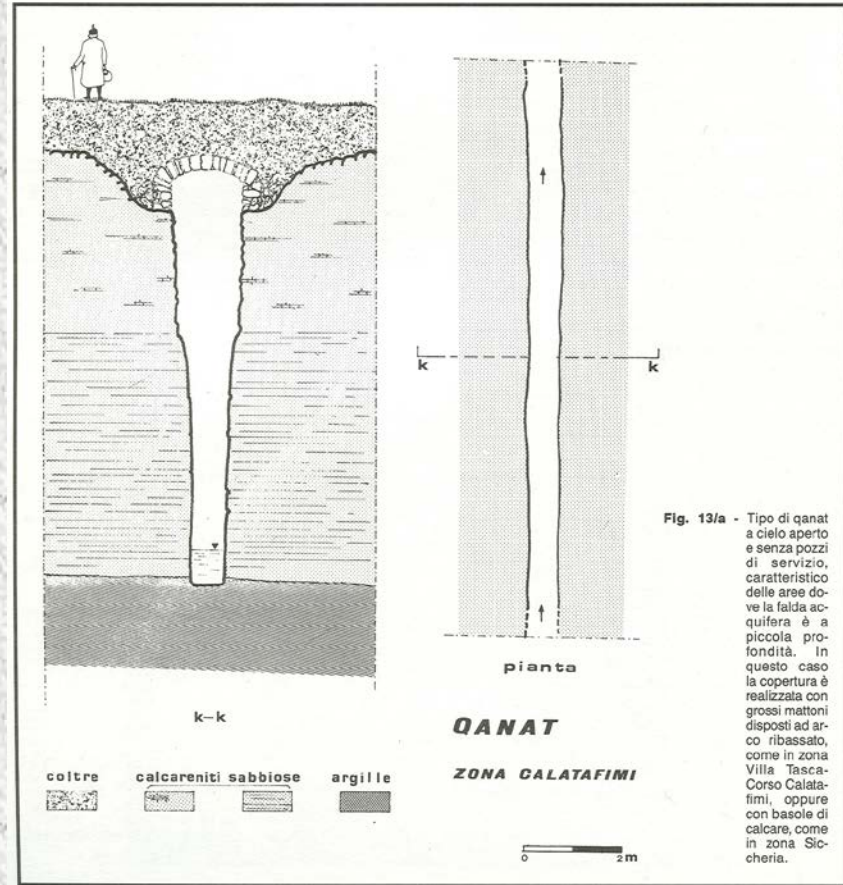
**C** Largo S. Rosalia, via Gianferrara, piazza S. Cosimo, via Judica, piazza Monte Pietà, via Panneria, piazza S. Onofrio, discesa dei Giovenchi, attraversa via Maqueda, entra in via Bandiera, via Allegra, vicolo Mango, vicolo Guardiola, vicolo della Tavola Rotonda, vicolo Madonna della Provvidenza, finisce in piazza Castello.

**D** via Calderai, piazza S. Antonio, via Terra delle Mosche, vicolo Zecca, Porta Felice.





**Fig. 9** - Spaccato di un pozzo qanat «tombato» di Palermo, cioè di uno dei numerosi pozzi seriali che a intervalli di 20 m danno accesso a una lunga galleria che porta l'acqua. Sul fondo è ricavata una riserva idrica («dote») che tracimando garantisce la continuità del deflusso, permettendo nel contempo di attingere l'acqua come da un normale pozzo. I piccoli incavi che si notano lungo la canna sono le 'pedarole' che consentono di raggiungere agevolmente la galleria senza l'uso della scala.



**Fig. 13/a** - Tipo di qanat a cielo aperto e senza pozzi di servizio, caratteristico delle aree dove la falda acquifera è a piccola profondità. In questo caso la copertura è realizzata con grossi mattoni disposti ad arco ribassato, come in zona Villa Tasca-Corso Calatafimi, oppure con basole di calcare, come in zona Siccheria.



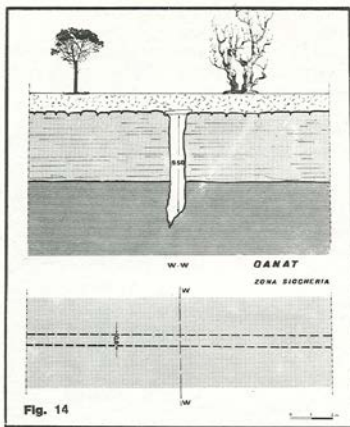


Fig. 14

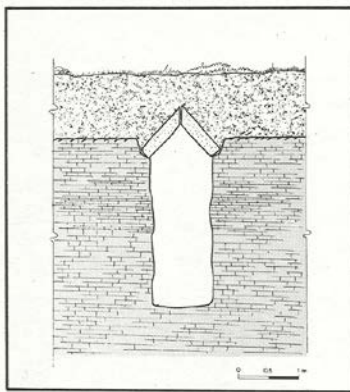


Fig. 15 - Caratteristica sezione trasversale del qanat di Castelforte (Partanna Mondello) che con i suoi 1400 m di lunghezza attraversa la piana dei Colli. La copertura è realizzata «a bocca di forno» con due conci di tufo inclinati a doppio spicciante.

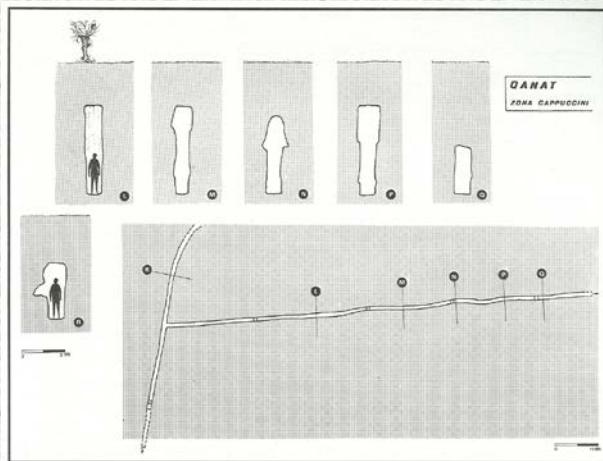


Fig. 16 - Andamento planimetrico del qanat di via Pindemonte-via Cappuccini. In alto a sinistra alcune caratteristiche sezioni trasversali rilevate lungo il tracciato.

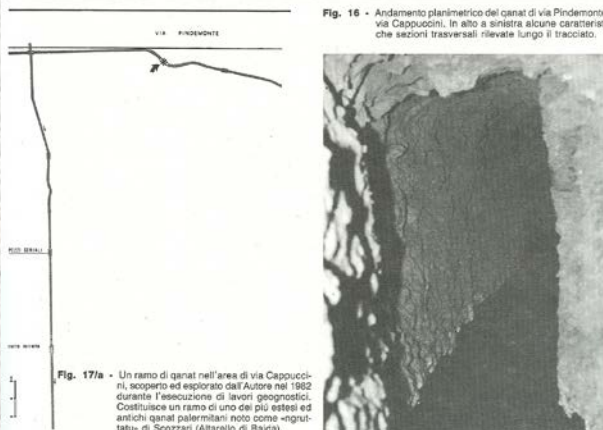


Fig. 17/a - Un ramo di qanat nell'area di via Cappuccini, scoperto ed esplorato dall'Autore nel 1982 durante l'esecuzione di lavori geognostici. Costituisce un ramo di uno dei più estesi ed antichi qanat palermitani noto come «ngruttatu» di Scozzari (Altarelli di Badca).

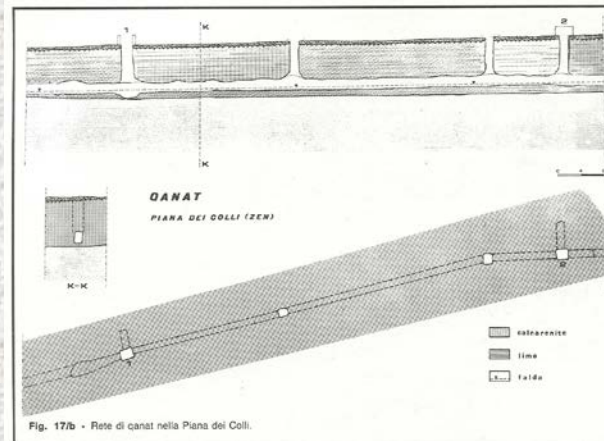


Fig. 17/b - Rete di qanat nella Piana dei Colli.

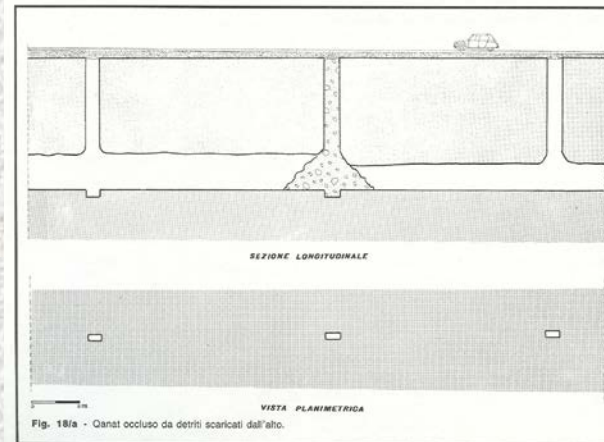


Fig. 18/a - Qanat occluso da detriti scaricati dall'alto.





Fig. 24 - Uno stretto passaggio del qanat di via Pindemonte.



Foto 25 - Vistosi sgrottamenti lungo i fianchi del qanat di via Pindemonte.



Foto 26 - Tratto di qanat in calcarenite particolarmente tenace.



Foto 27/a - Tratto in curva per evitare un banco di roccia dura.



Foto 27/b - Tretto di qanat all'incrocio di corso Calatafimi con la Circonvallazione alla profondità di circa 10 m. La copertura è realizzata con lastroni calcarenitici posti a «bocca di fornace».



Foto 32 - Diffusi depositi calcitici incrostanti prodotti dalle acque sorgive.

Foto 28 - Strettissimo qanat nell'area di Villa Tasca.

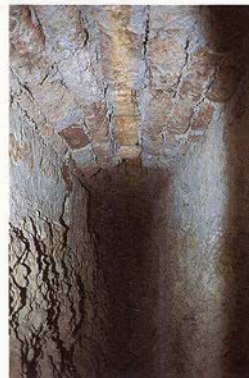


Foto 29

Foto 29 - Qanat di corso Calatafimi-Villa Tasca.



Foto 30

Foto 30 - Pozzo di accesso di qanat di via La Loggia.



Foto 31

Foto 31 - Qanat inaridito di Altarelli di Baida-via Pitrè. Si notano i muretti a secco sistemati lungo le pareti sabbiose meno stabili.



Foto 33 - Alcuni ingressi alle muchate della Castellana in via Ammiraglio Rizzo, seminascolti dai detriti.



# L'acqua di Matera

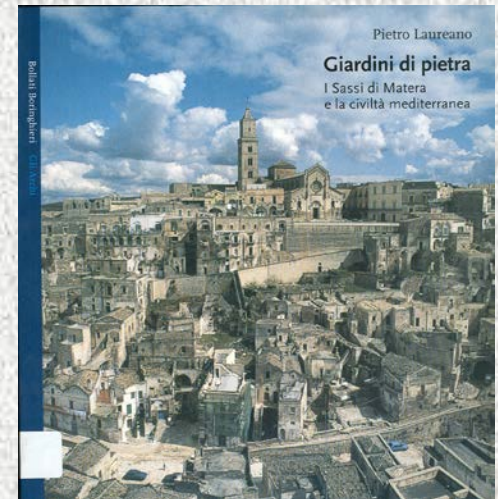






Image © 2010 European Space Imaging

2008 Google

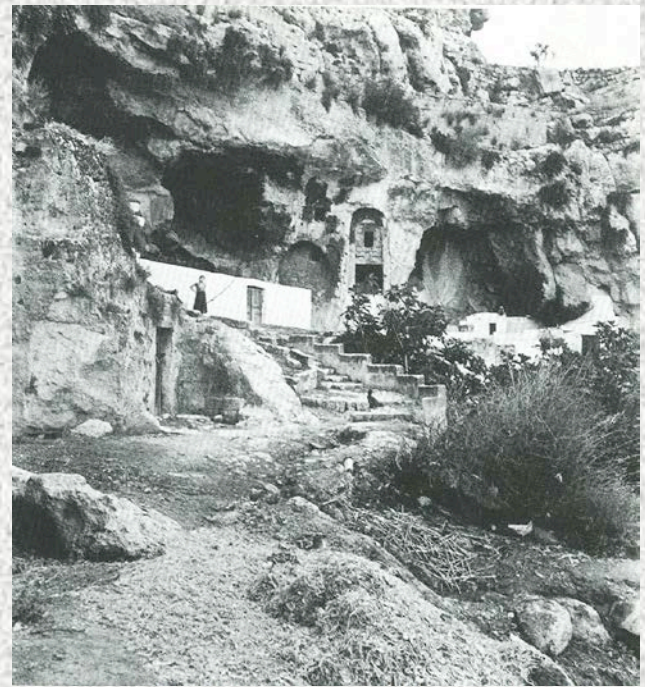
Data di acquisizione delle immagini: 8 Ago 2007 40°40'02.59" N 16°36'34.83" E 0 m elev

336 m Alt

























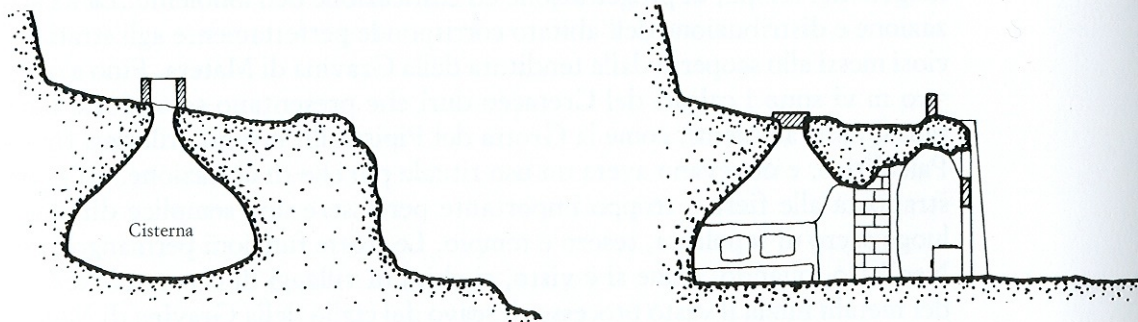












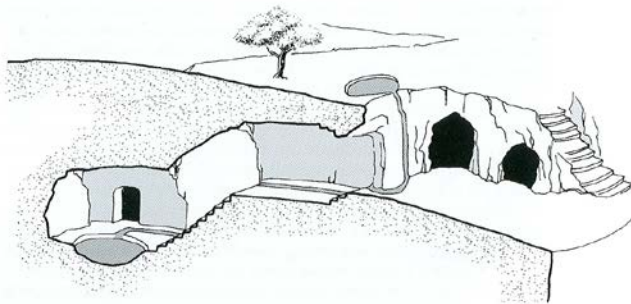
63. Trasformazione di una cisterna in abitazione



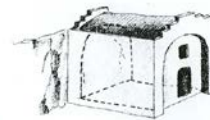
64. Grotta



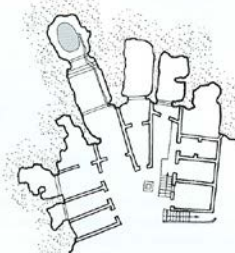
65. Jazzo. Pianta e sezione



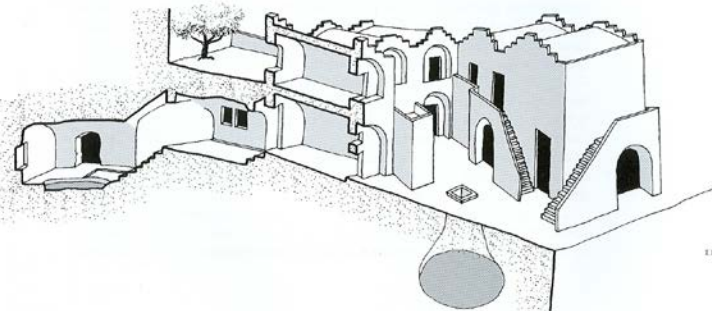
66. Grotta tamponata



67. Lamione



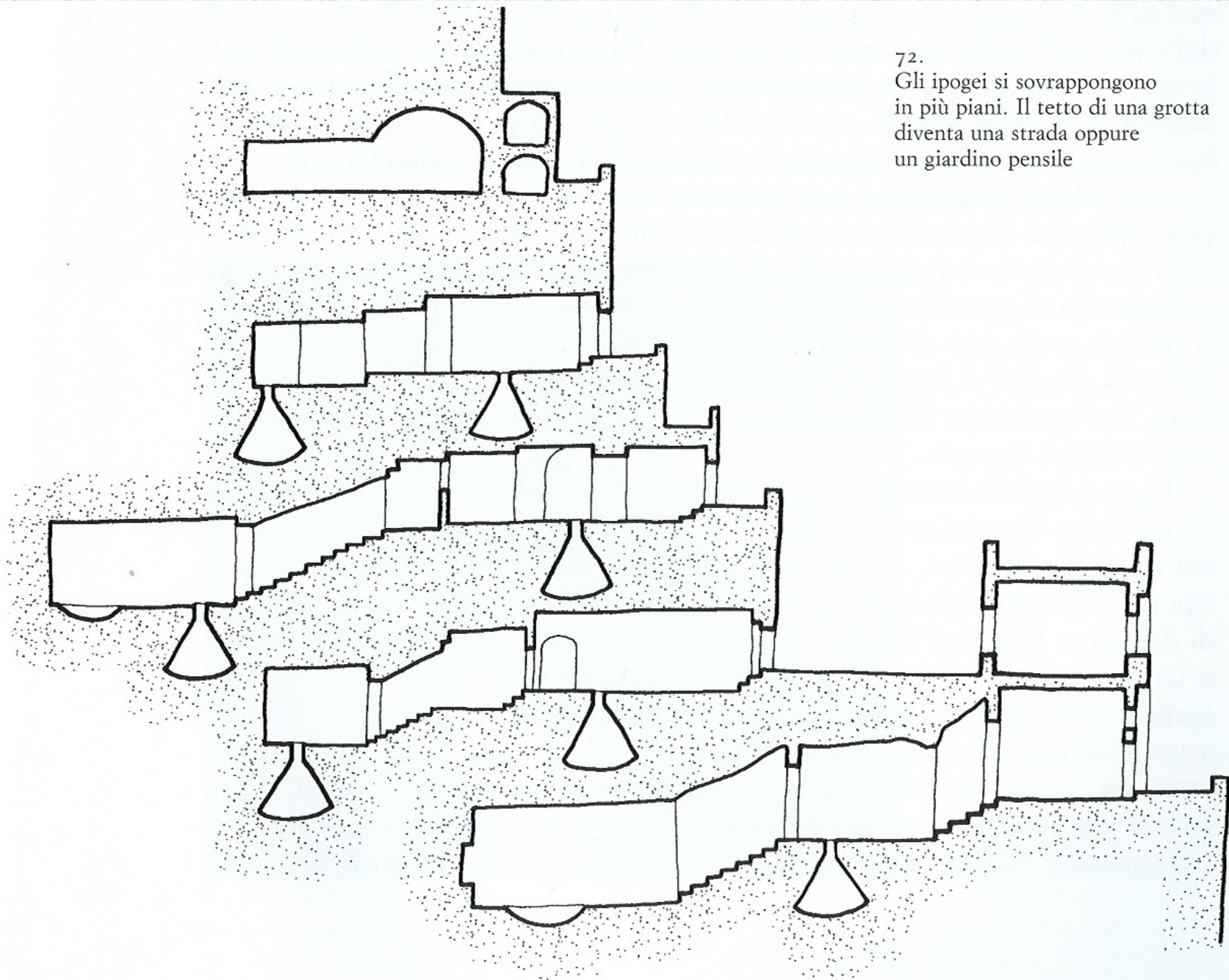
68. Vicinato. Pianta e sezione



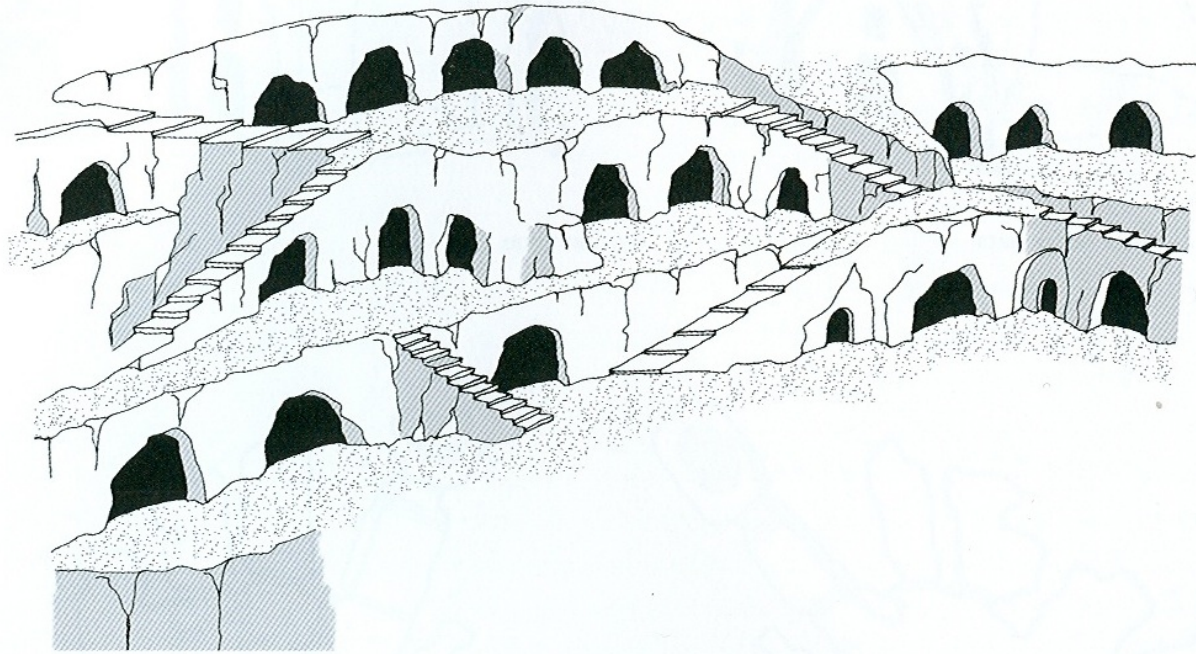


72.

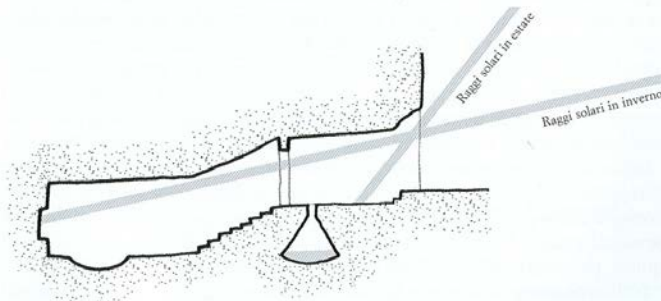
Gli ipogei si sovrappongono  
in più piani. Il tetto di una grotta  
diventa una strada oppure  
un giardino pensile







69. Gli ipogei lungo il pendio a gradoni si configurano con forme a ferro di cavallo intorno ai terrazzi coltivati



70. L'altezza del sole nelle stagioni determina l'inclinazione dello scavo









Conca  
del Sasso Barisiano

Ciglio dell'altipiano

Colline argillose

Altipiano murgico

Sperone della Civita

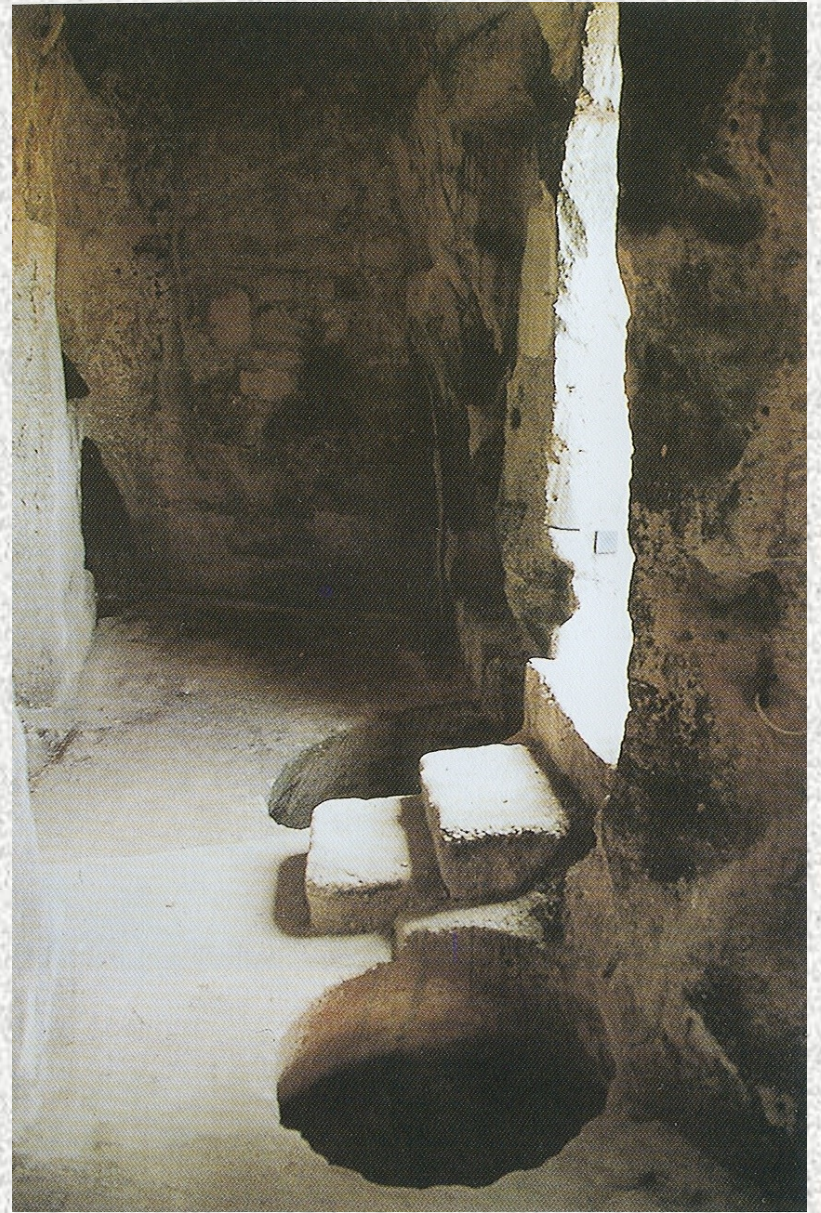
Conca  
del Sasso Caveoso

Gravina











# L'acqua di Siena







Gli acquedotti di Siena



PIANTA DEI BOTTINI  
DELLA  
CITTÀ DI SIENA

nella proporzione al verso di 1 a 10000.

I bottini dotano la città di un sistema di circolazione sotterraneo di acqua che si conclude nel centro urbano.



Gli acquedotti di Siena









# Gli acquedotti di Siena

























Image © 2010 GeoEye

Data di acquisizione delle immagini: 25 Set 2003 43°19'04.65" N 11°19'56.06" E 0 m elev

2009 Google

332 m Alt

















# L'acqua di Piombino

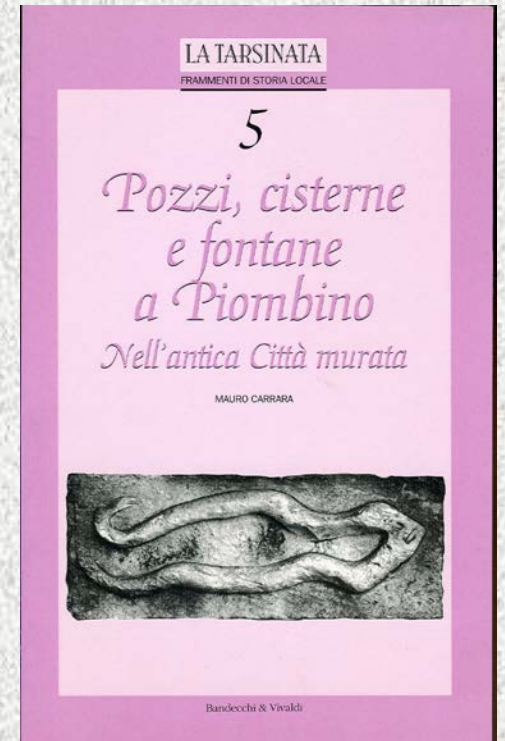






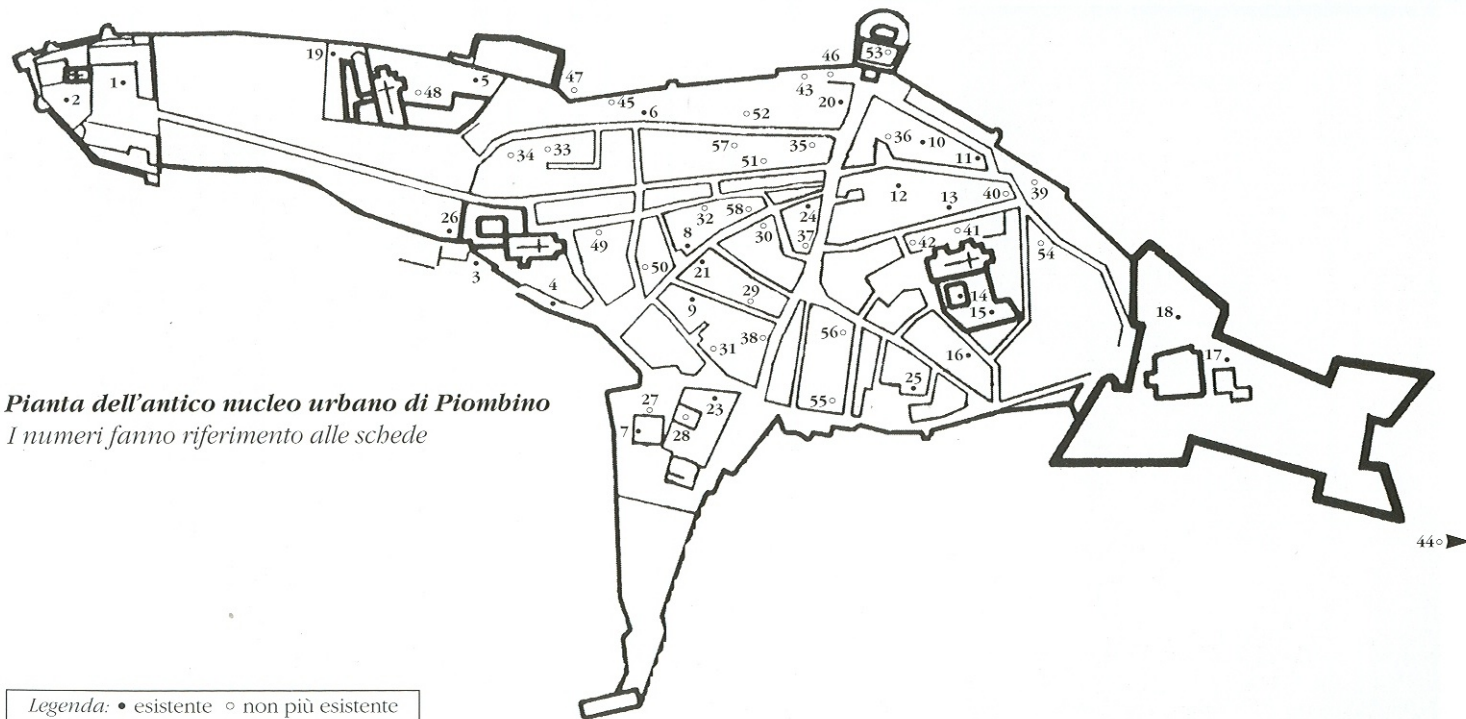
Image © 2010 DigitalGlobe  
Data SIO, NOAA, U.S. Navy, NGA, GEBCO  
Image © 2010 TerraMetrics

©2009 Google

Data di acquisizione delle immagini: 25 Lug 2007 42°57'26.04" N 10°31'29.28" E 0 m elev

10.28 km Alt 

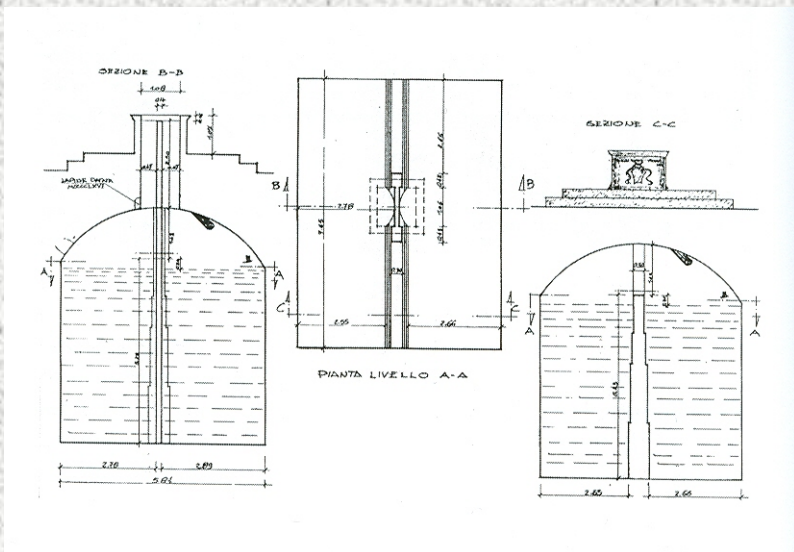
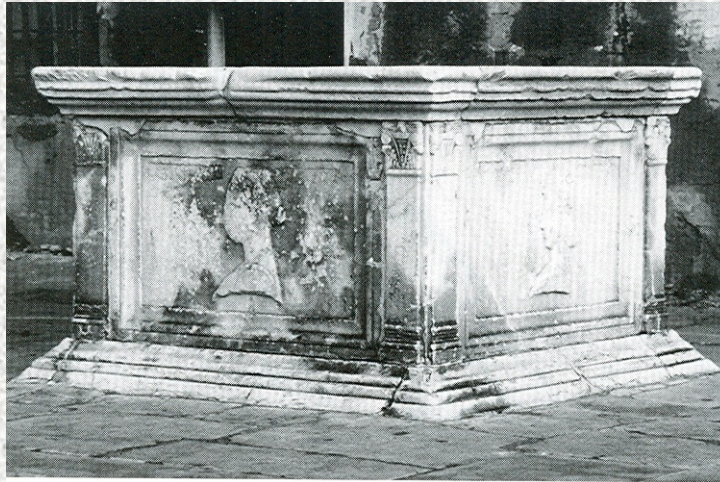




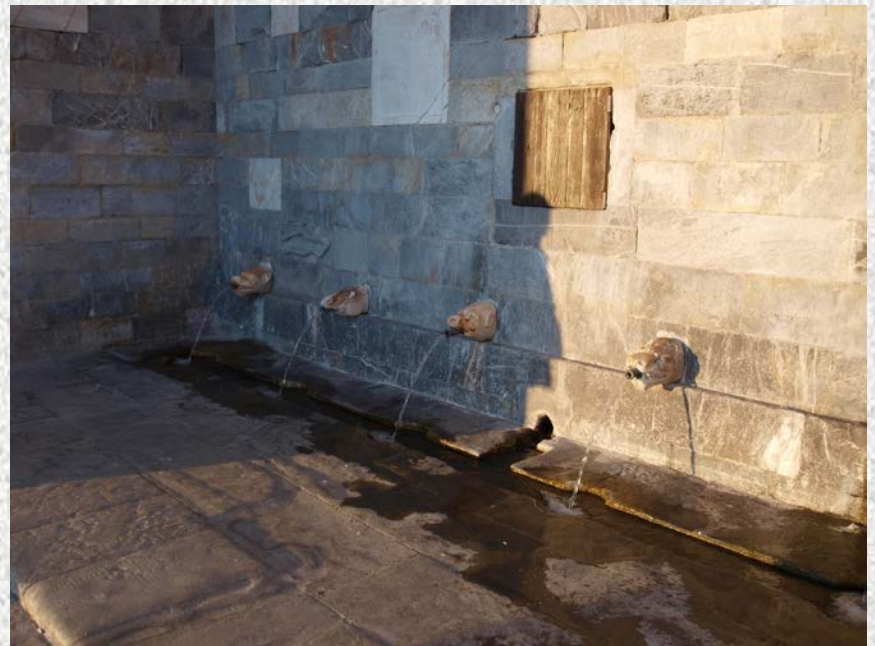
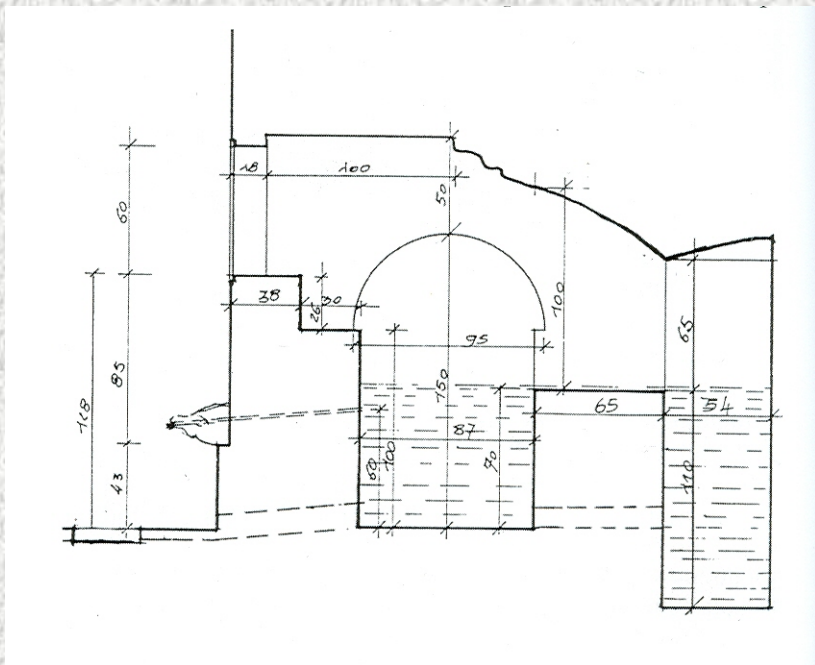
*Pianta dell'antico nucleo urbano di Piombino*  
*I numeri fanno riferimento alle schede*

Legenda: • esistente ◦ non più esistente

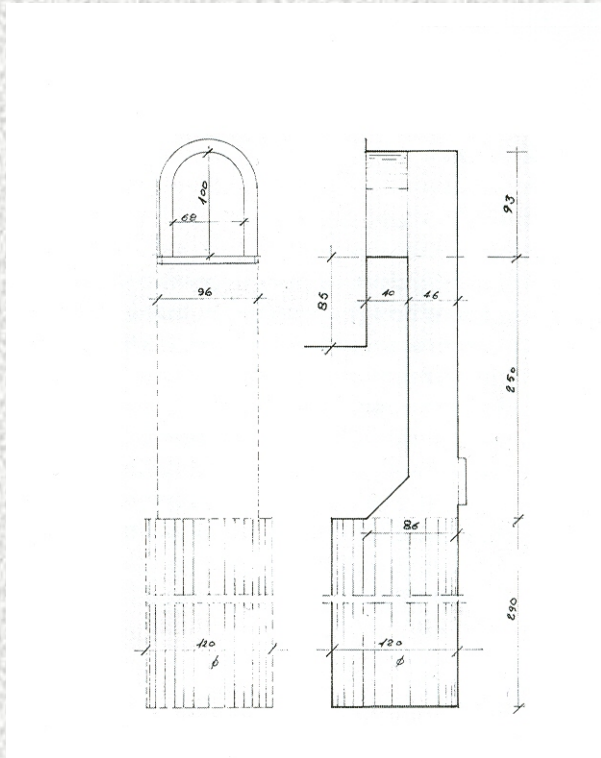














# L'acqua di Livorno

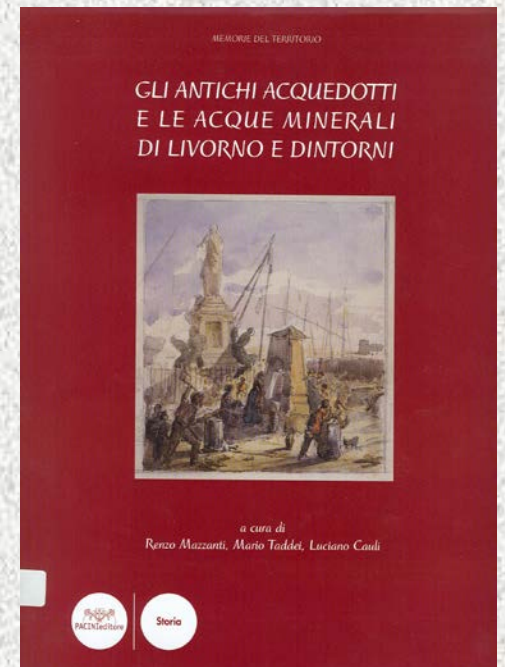
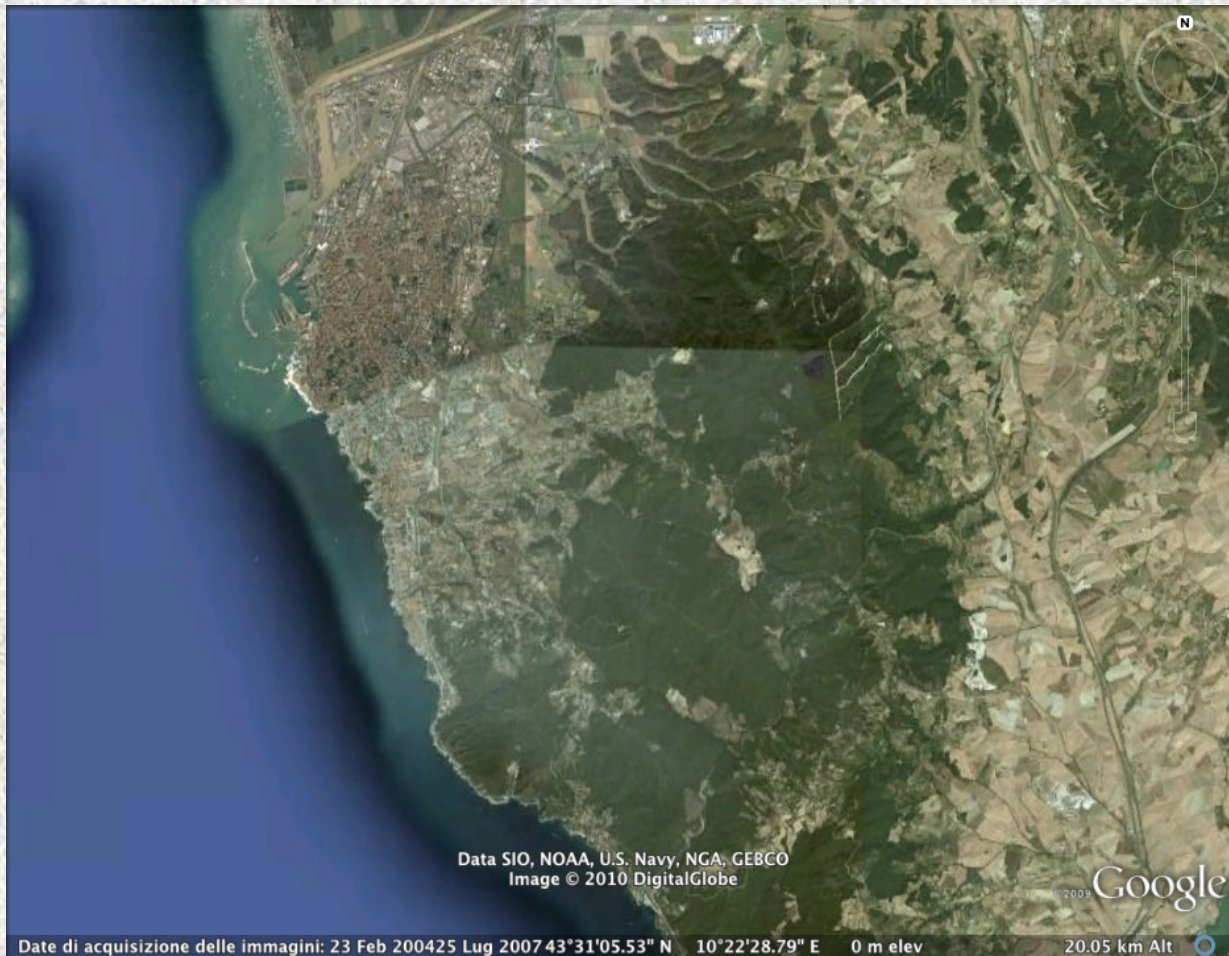








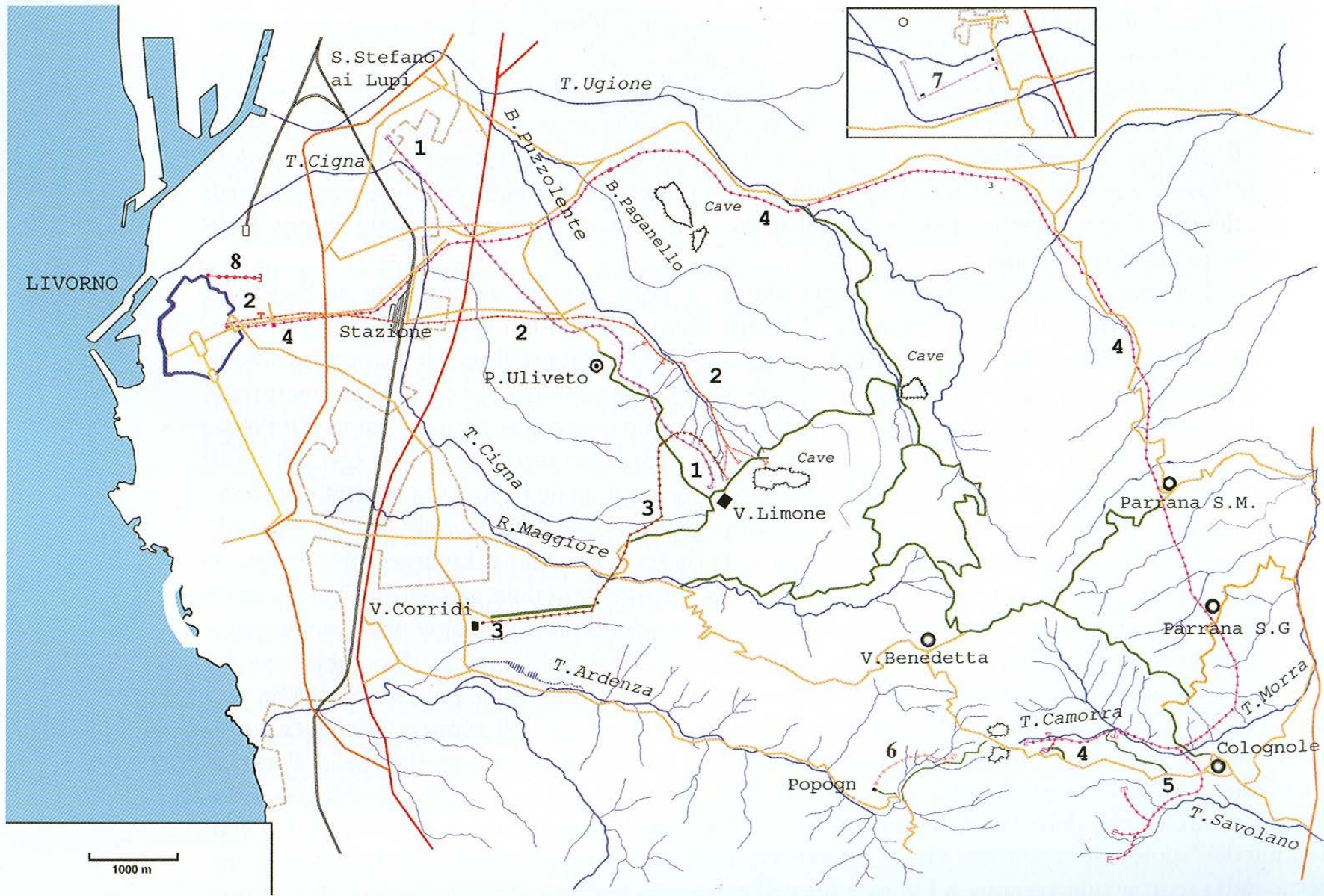


Image © 2010 DigitalGlobe

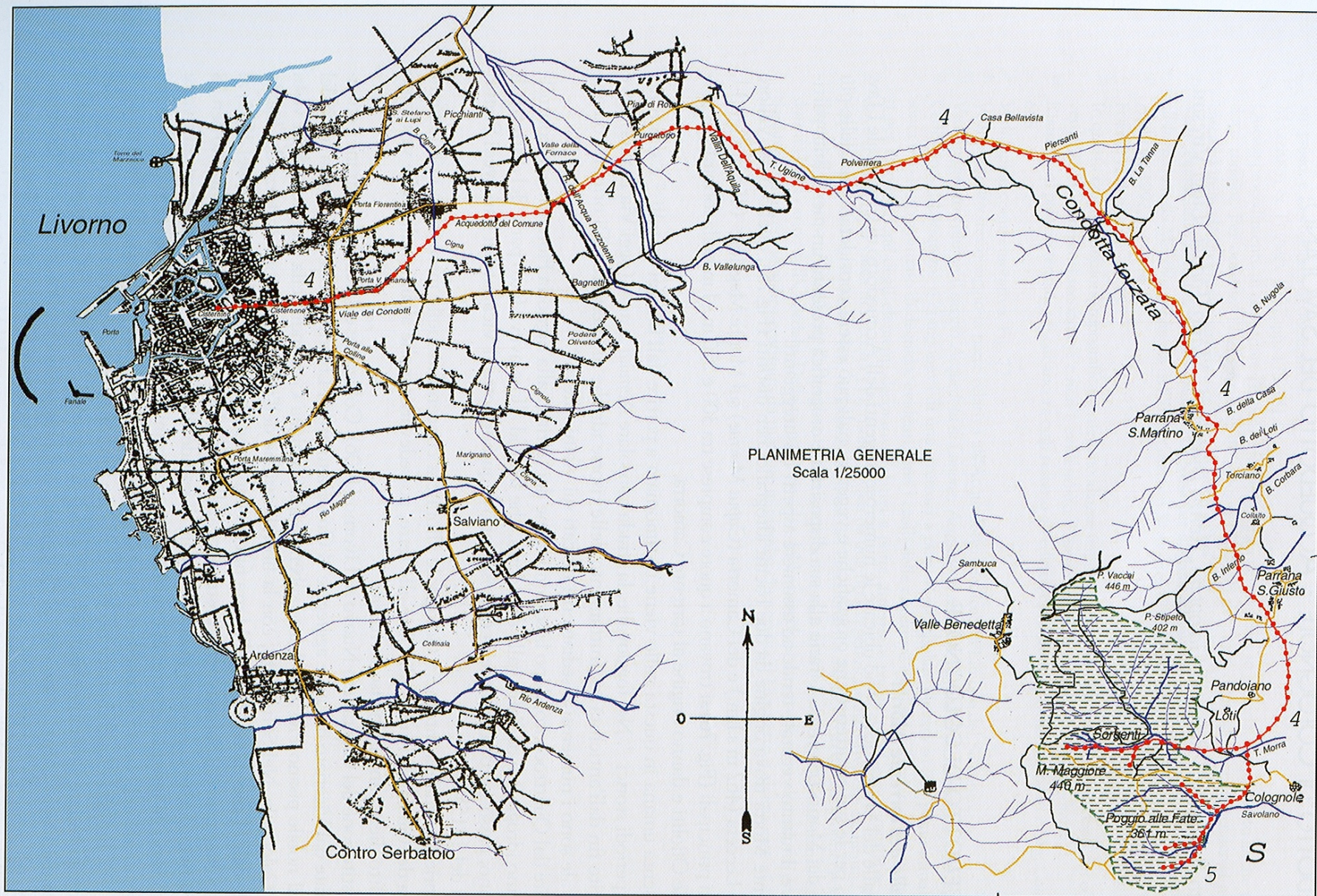
©2009 Google

Date di acquisizione delle immagini: 23 Feb 2004 16 Ago 2004 43°33'13.04" N 10°19'09.54" E 0 m elev 3.89 km Alt



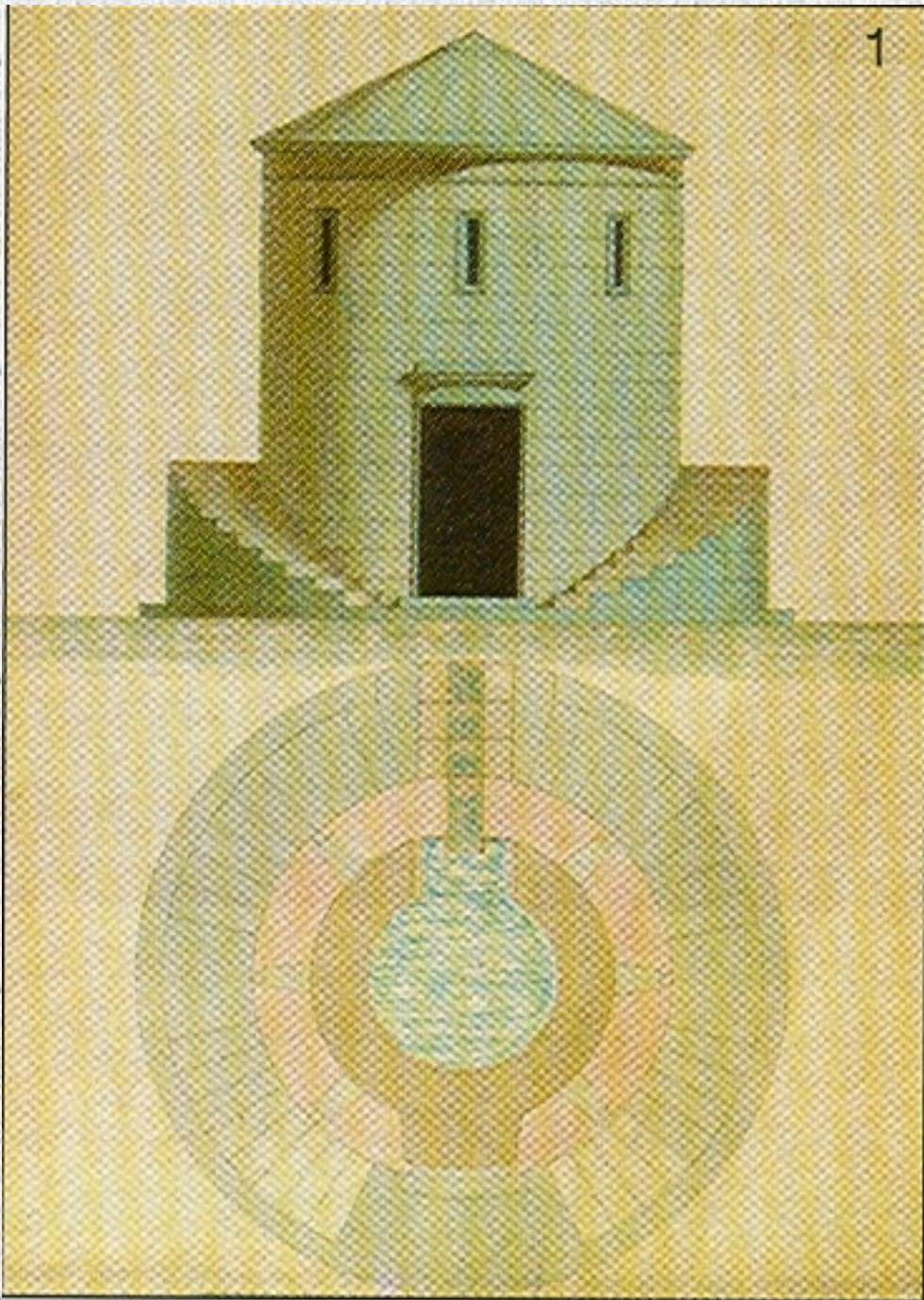




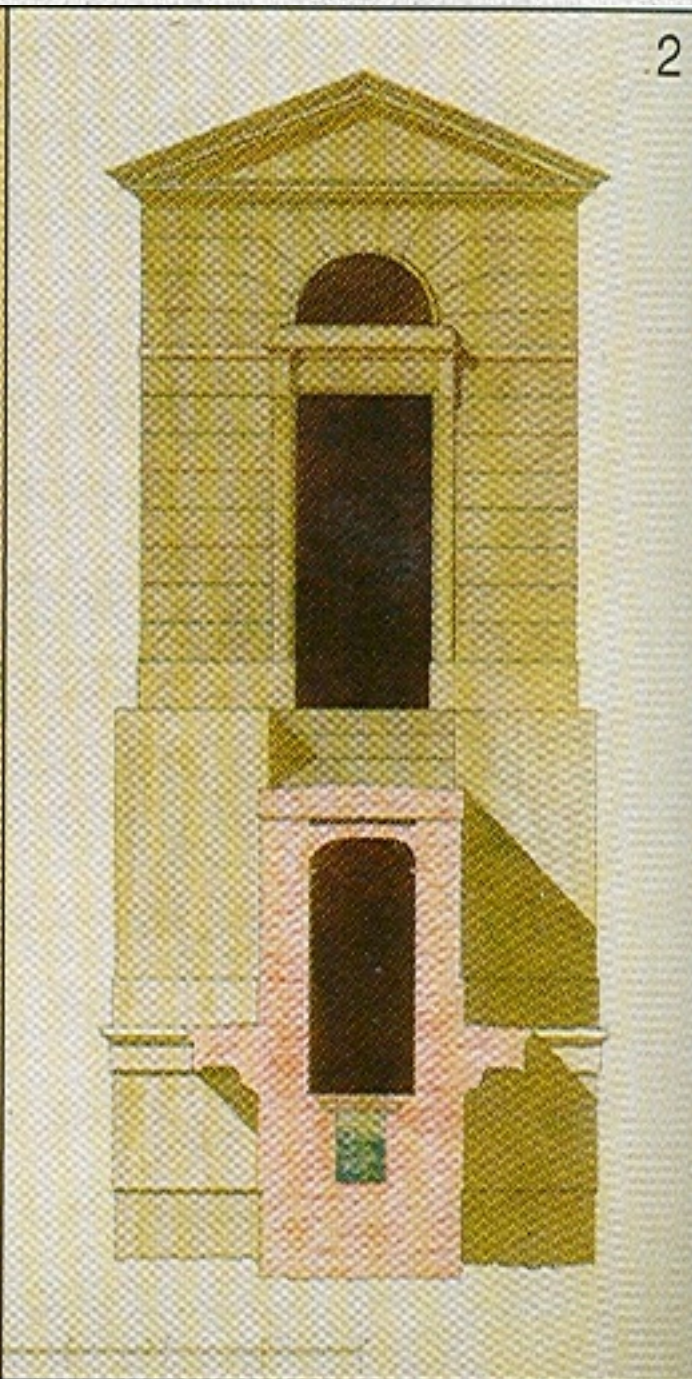




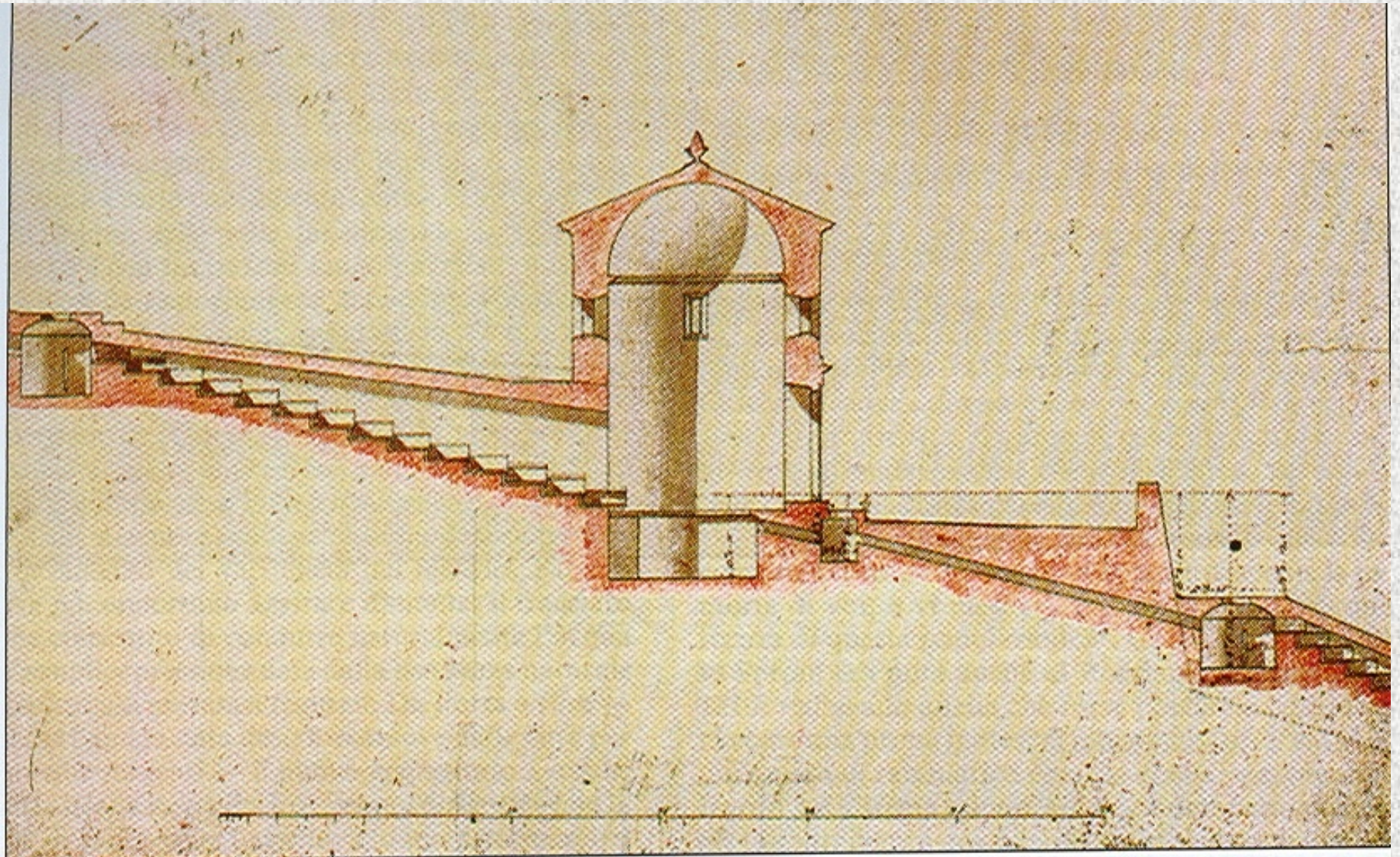
1



2



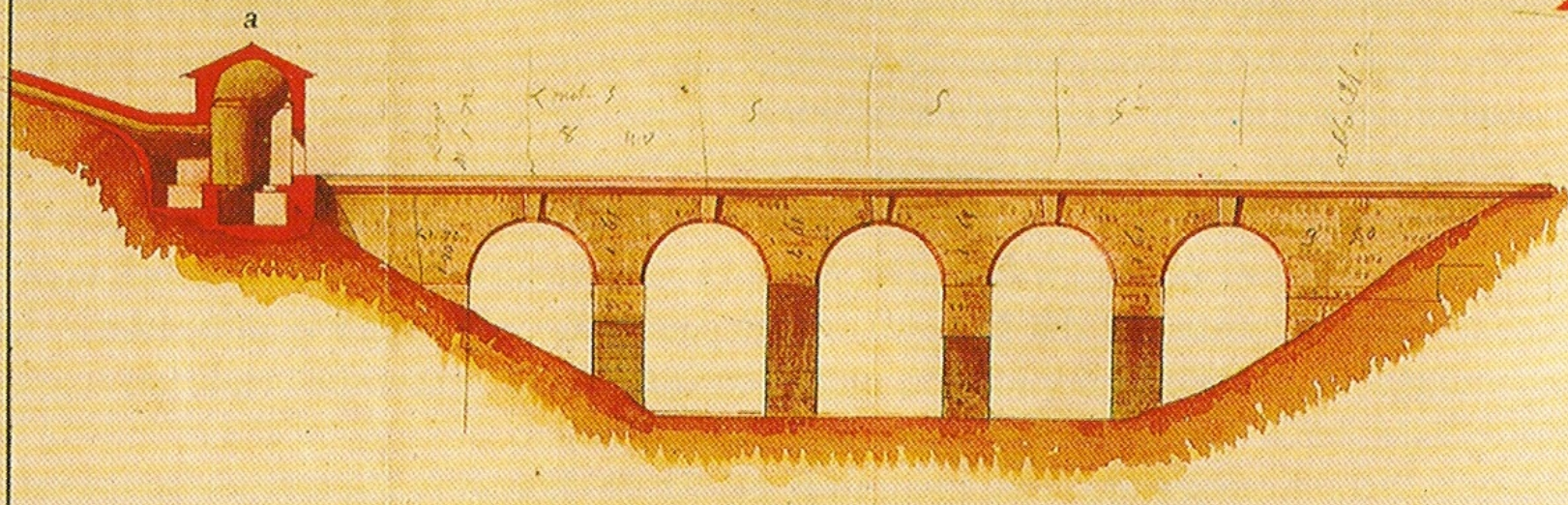






Partie N<sup>o</sup>. Arcade a construire à travers la Vallée della Castellaccia

6  
199



2. Pièce appartenante à la partie N<sup>o</sup> IV. Mires



Passini di S. Maria

7225



1

*Sezione sulla Linea A B.*



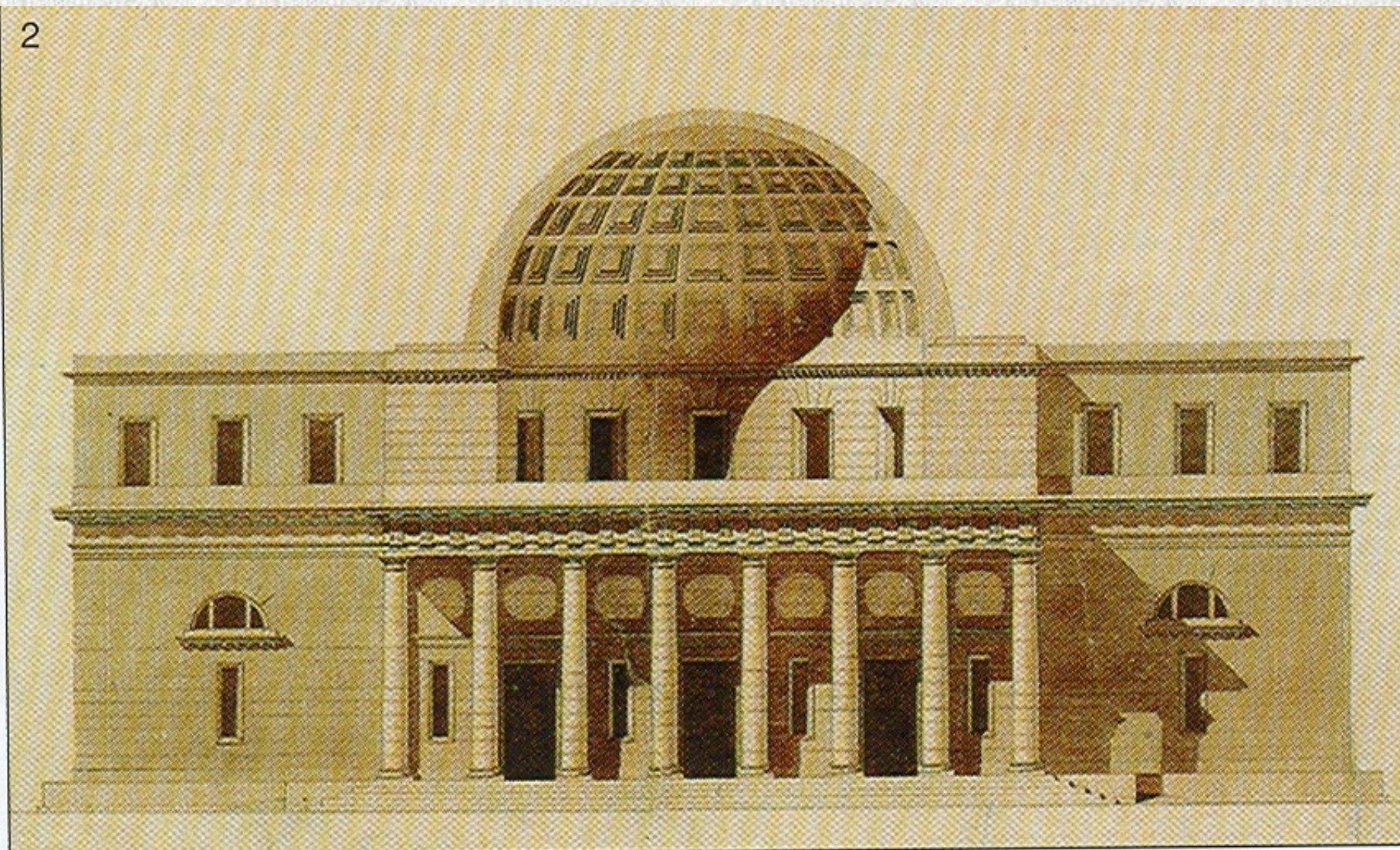
*Facciata del Purgatorio da edificarsi nel Pian-di-Rota.*



*Arch. del Purgatorio. L. 1. Tav. 1.*



2

























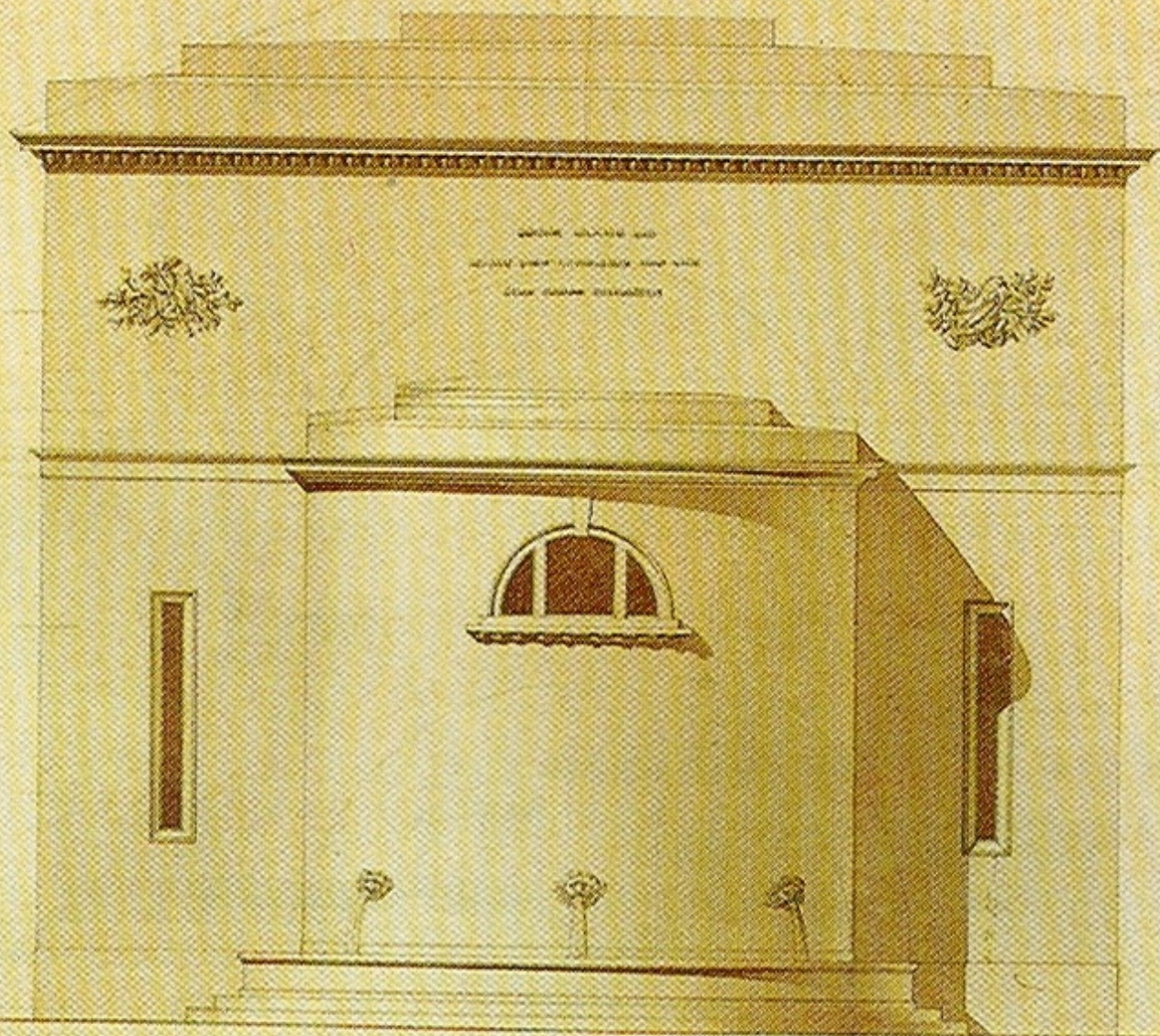








Disegno della Chiesa da edificare nella Piazza di S. Bartolomeo in Pisa



Disegno di Domenico Fontana









**CHE FARE?**  
NEL CATERING?  
PROSSIMI PARTNER VITE...  
INVIATI  
PRESENTATI ALLA CITTA'  
"EL HERRERA 2008"  
LAVORI IN CORSO

ALBERTO HERRERA CALVO TAMAYO 2010

CAUSE N. 1000



# Riferimenti bibliografici:

(Claudio Saragosa, *L'insediamento umano, ecologia e sostenibilità*, Donzelli, Roma, 2005).